

Practical Computing

August 1982

Volume 5 Issue 8

Machine intelligence:
Game strategies
Pattern recognition

Reviews:
Hard-disc
Televideo
Sharp pocket micro
Oasis

The selling message

Machine code with CP/M

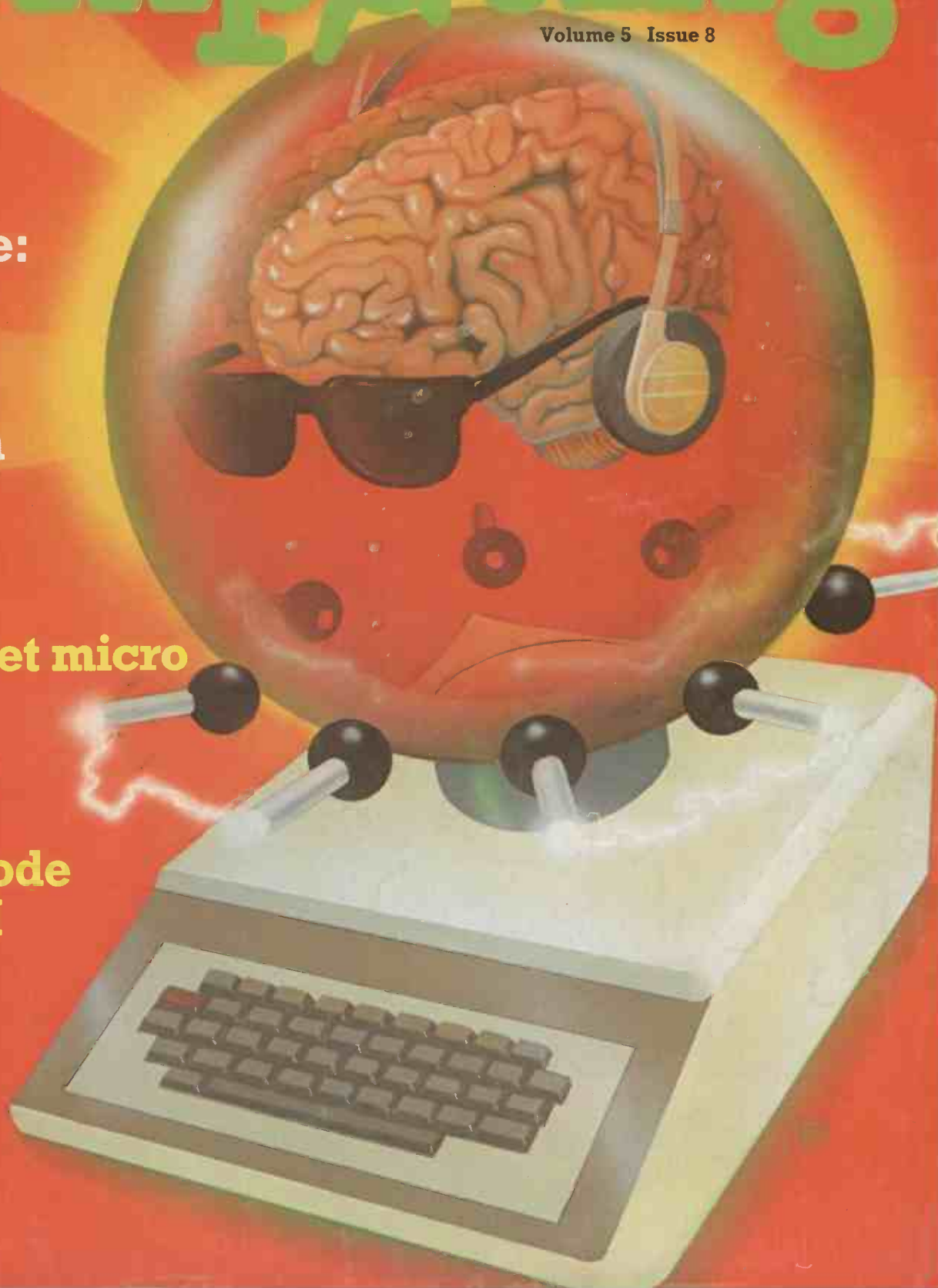

**NEW
MODEL**

**LOWER
COST**



Cromemco System One

MicroCentre introduce Cromemco's new System One computer, available with an integral 5 megabyte Winchester hard disk, at a new low price.

The System One supports the full range of Cromemco interface cards, including high resolution colour graphics, and software packages. The choice of operating systems includes CDOS, CP/M and CROMIX—Cromemco's answer to Unix.

Call MicroCentre for  Cromemco

2

MicroCentre Ltd
(Complete Micro Systems)

● Circle No. 101

**Britain's independent
Cromemco importer**

**30 Dundas Street
Edinburgh EH3 6JN
Tel: 031-556 7354**



Machine intelligence — page 77

Editor
Peter Laurie 01-661 3609
Deputy Editor
Bill Bennett
Reporter
Ian Stobie
Production Editor
John Liebmann
Sub-editor
Sally Nicholls
Editorial Secretary
Julie Milligan
Consultant
Chris Bidmead
Advertisement Manager
Ian Carter 01-661 3021
Assistant Advertisement Manager
Kenneth Walford 01-661 3139
Advertisement Executives
Fiona Howell 01-661 3468
Robert Payne 01-661 8425
Advertisement Secretary
Janet Thorpe
Midlands office:
David Harvett 021-356 4838
Northern office:
Geoff Aikin 061-872 8861
Publishing Director
Chris Hipwell

Published by IPC Electrical Electronic Press Ltd, Quadrant House, The Quadrant, Sutton, Surrey SM2 5AS. Tel: 01-661 3500. Telex/grams 892084 BIP-RESG.

Typeset and printed by Eden Fisher (Southend) Ltd, Southend-on-Sea. Distributed by IPC Business Press (Sales and Distribution) Ltd, Quadrant House, The Quadrant, Sutton, Surrey SM2 5AS.

Subscriptions: U.K. £10 per annum; Overseas £16 per annum; selling price in Eire subject to currency exchange fluctuations and VAT; airmail rates available on application to Subscription Manager, IPC Business Press (S & D) Ltd, Oakfield House, Perrymount Road, Haywards Heath, Sussex RH16 3DH. Tel: 0444 459188.

©IPC Business Press Ltd 1982
 ISSN 0141-5433

Would-be authors are welcome to send articles to the Editor but PC cannot undertake to return them. Payment is at £30 per published page. Submissions should be typed or computer-printed. Handwritten material is liable to delay and error. Every effort is made to check articles and listings but PC cannot guarantee that programs will run and can accept no responsibility for any errors.

CONTENTS

- 33 Editorial** / A new shape for the micro industry?
37 Feedback / Readers' letters — BBC Basic: WordStar

News

- 40 Printout** / More from Xerox: 32-bit micros
45 Printout extra / Peter Laurie visits the Timex plant where Sinclair's products are assembled

Machine intelligence

- 77 Basic steps towards intelligent programs** / The promised fifth generation of computers will be intelligent, but Mike Costello shows how you can jump the gun and use AI techniques now
85 Morse code / Pattern recognition is one of the most popular AI applications; Christopher Dracup and Derek Wakelin teach a Pet to tell the dots from the dashes

Reviews

- 48 Sharp PC-1500** / Processing power which fits in the pocket, examined by Bill Bennett
54 Televideo 802 / Chris Bidmead takes a look at a fast new computer with hard discs
61 Graphpac / CCSOFT's package for driving intelligent high-resolution graphics, reviewed by Nick Laurie
70 Oasis / An operating system for the modern microcomputer? David Watt investigates
163 Books / Starting Forth: Software protection
187 The War Machine / More bloodthirsty deeds on the screen

Software

- 98 CP/M** / Password security system from Adrian Hill
116 Game / Chris Hinstead provides a version of the popular arcade game to run on CP/M micros
127 Apple Stock / Robin Kanagasabay's stock-control program runs on the Apple II micro

Programming

- 91 Languages** / Adrian Smith describes his favourite, APL — not so much a computer language, more a form of notation
120 Structured programming / Part 2 of Graham Beech's series
133 Open file / 14 pages of software for the more popular micros, including Pet, Apple, ZX-81 and BBC machines
105 Searching for truth / Boris Allan philosophises on program correctness
108 Putting your message across in print / Writing documentation and brochures is an important part of selling software, and Clive Wilkins points out the rights and wrongs
125 Art / More points from the portfolio of Brian Reffin Smith
165 Puzzle
167 Software buyers' guide

The Network has arrived...

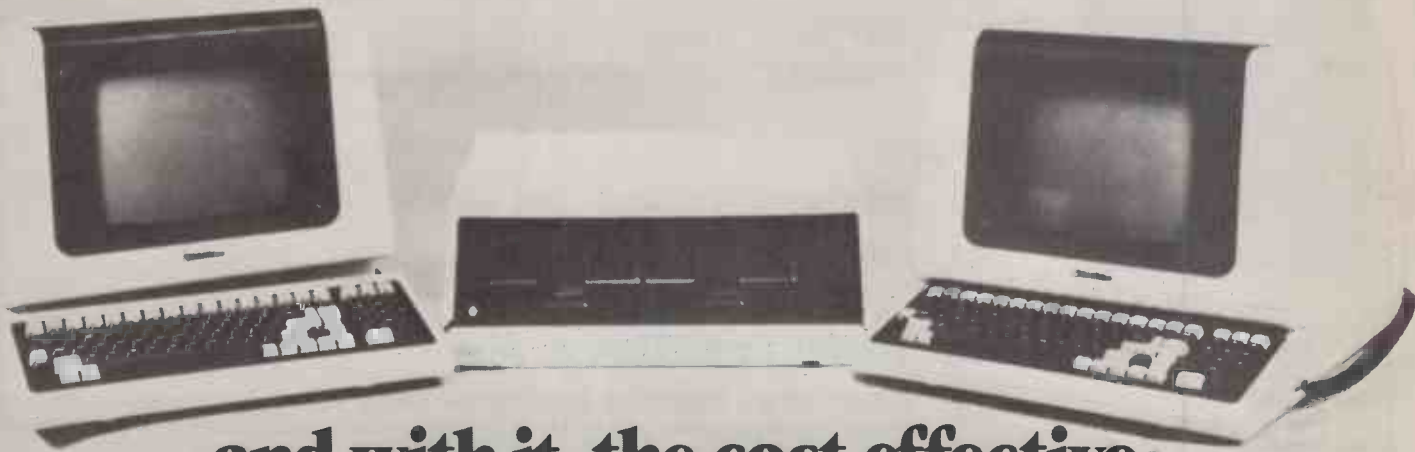

and with it, the cost effective alternative to dumb terminals and expensive minmainframes.

The TeleVideo computer family from Encotel puts total processing power where it's needed — in the hands of the user — while allowing expansion without compromise to individual terminal performance.

MmmOST* and CP/M® together protect both software investment and the route to upwards expansion. They provide all the house-keeping required to run a multiple user database and ensure that application programs will not have to be re-written no matter how big the system grows. Any of today's most popular languages, such as **COBOL**, **BASIC** and **FORTRAN** can be used.

The TeleVideo family will expand from the stand-alone System I with its 64Kbytes of user RAM and 1Mbytes of floppy disk up to the 16-user System III with its 70Mbytes of hard disk Winchester, without hardware redundancy.

Furthermore, the RS422 800Kbit/second data links make each highly intelligent terminal look like a mainframe.

Only the low price says it isn't.

For instance the six terminal System 2 with its 7.5Mbytes of hard disk and 384Kbytes memory starts at around **£10,000**†.

As expected from a world class terminal manufacturer like TeleVideo the TS800 terminals used to expand Systems 2 and 3 are exceptional. The 64Kbytes of RAM, serial printer port and separate processors for compute and display ensure that they will never lack power.

And that the user will never be out of pocket.

* *Multiuser multitask multiprocessor Operating Systems Technology*®

† based on 2\$ exchange rate.

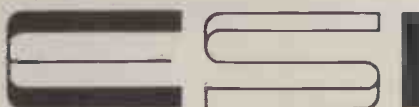

Encotel Systems Limited,
7 Imperial Way,
CROYDON, Surrey.
Tel: 01-686 9687/8 Telex: 265605.

From the people who believe in Quality, Reliability and Support.

Specifications

System I

Single-board processor containing 1 Z80A 64K of RAM memory.
4K EPROM for diagnostics
1.0Mbytes of on-line mini-floppy disk storage
TeleVideo Model 910 CRT terminal with all Model 910 capabilities (950 terminal optional).

£2,280.00

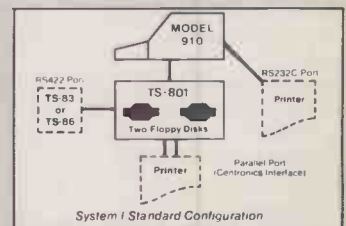

System I Standard Configuration

System II

Supports up to six users
Single board design
Z80A, 64K of RAM memory
4K EPROM
7.5Mbytes 5 1/4" Winchester disk drive
0.4Mbyte mini-floppy disk back-up unit
Parallel port and two serial ports for printer attachment and servicing

With one TS800 £5,130.00

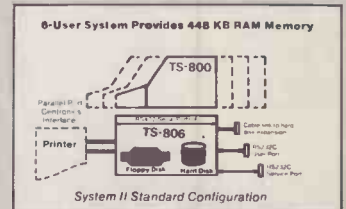

System II Standard Configuration

System III

Supports up to 16-users
processing network contains, Z80A, 64K of RAM memory, 4K EPROM
23.5Mbyte 8" Winchester disk drive
MmmOST* Service Processing System. 2 x TS80

£9,995.00

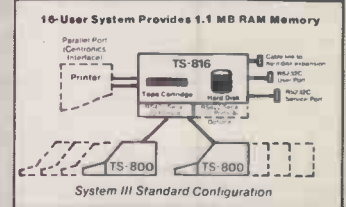

System III Standard Configuration

TS 80 Satellite User Station

6502 CPU for video control Z80A for computing
64K of RAM memory 4K EPROM RS 422 Networking Serial Port
Full-screen editing and graphics capabilities **£1,026.00**

ESL Dealers

Applied Micros Ltd. 14 Clifton Road, Heaton Moor, Stockport, Cheshire.
Tel: 061-431 9390

Atlantic Microsystems Ltd. 72 Honor Oak Park, London SE23.
Tel: 01-699 2202

Bondbeat Ltd. 66 Wells Street, London WC1. Tel: 01-580 7249/6701

Boyd Microsystems Ltd. 59 High Road, Bushey Heath, Herts.
Tel: 01-950 0303

D.D.M. Ltd. 10 High Street, Southend-on-Sea, Essex. Tel: 0702 65787

Easi Bee Computing Ltd. 133-135 High Street North, London E6 1HZ.
Tel: 01-471 4884

The Electronic Office 32 West Street, Brighton, Sussex. Tel: 0273 72248/9

ISI Computer Services Ltd. Millwood House, Middle Assendon,
Henley-on-Thames, Oxon. Tel: 04912 77735

Mercator Computer Systems 3 White Ladies Road, Clifton, Bristol.
Tel: 0272 312079

Micro People Ltd. 1 Union Street, Long Eaton, Nottingham NG10 1HH.
Tel: 06096 69117

● Circle No. 102

WATFORD ELECTRONICS

33/35, CARDIFF ROAD, WATFORD, HERTS, ENGLAND.
Tel Watford (0923) 40588. Telex: 8956095

ALL DEVICES FULL SPEC. AND FULLY GUARANTEED. TERMS OF BUSINESS: CASH/CHEQUE/P.O.S. (OR ACCESS) WITH ORDER. GOVERNMENT AND EDUCATIONAL INSTITUTIONS OFFICIAL ORDERS ACCEPTED. TRADE AND EXPORT INQUIRIES WELCOME. (P&P add 50p on all cash orders).

VAT ALL PRICES ARE EXCLUSIVE OF VAT. PLEASE ADD 15% TO THE TOTAL COST INCLUDING P&P.
SHOP HOURS: 9.00am-6.00pm MONDAY TO SATURDAY.
AMPLE FREE CAR PARKING SPACE AVAILABLE.

COMPUTER IC's	MM74C922	420	74151	40	4161	99	4549	375	40107	60
1702	350	74151	40	4162	99	4572	36	40108	450	
1802CP	650	74154	55	4163	99	4583	99	40109	100	
2101-2	150	SF93634E	25	4174	99	4584	48	40110	200	
2112-2	250	TMS2718-3	725	4175	105	4585	99	40114	240	
2114L-300n	80	TMS6011	365	4186	470	4411	690	4587	330	40163
2114L-200n	80	ULN2003	90	4188	250	4412	790	4589	290	40174
2147-3	425	UDP7002	440	4190	150	4507	60	4599	290	40183
2532-450n	360	Z80CPU2.5	299	4433	99	4503	35	40100	215	45106
2564	224	Z80ACPU4M	300	4441	46	40104	95	40244	195	45195
2708	515	Z80CTC	265	4519	30	40105	115	40373	240	45240
2716-5V	215	Z80ACTC	290	4539	90	40106	75	40374	245	
2732-450n	380	Z80DART	495	LS00	11					
2764	613	Z80DAMT	495	LS02	11					
4027	190	Z80DMA	995	LS04	12					
4116-150	95	Z80P10	265	LS10	13					
4116-200	40	Z80API0	275	LS11	13					
4118-250	325	Z80SIO-1	850	LS13	20					
4164-200	450	Z80SIO-2	850	LS20	13					
4323-3	430	Z80SIO-3	980	LS22	12					
(CMOS 2114)	325	Z80SIO-4	980	LS27	12					
4816A-120ns	225	Z80SIO-5	980	LS44	32					
4864-364K	785	Z80SIO-6	980	LS42	28					
5101	220	Z80SIO-8	300	LS47	35					
6116-150ns	390	Z80SIO-8	300	LS48	55					
6116-150n	520	Z80SIO-8	300	LS48	55					
6117-100n	490	Z80SIO-8	300	LS48	55					
6502	600	Z80SIO-8	300	LS48	55					
6504-250	550	Z80SIO-8	300	LS48	55					
6520	115	Z80SIO-8	300	LS48	55					
6521	320	Z80SIO-8	300	LS48	55					
6522 VIA	320	Z80SIO-8	300	LS48	55					
6530 RRIOT	£11	Z80SIO-8	300	LS48	55					
6532 RIOT	570	Z80SIO-8	300	LS48	55					
6545 CRTC	650	Z80SIO-8	300	LS48	55					
6551 ACIA	£20	Z80SIO-8	300	LS48	55					
6592 PC	275	Z80SIO-8	300	LS48	55					
6800	850	Z80SIO-8	300	LS48	55					
6802	850	Z80SIO-8	300	LS48	55					
6803	850	Z80SIO-8	300	LS48	55					
6804	160	Z80SIO-8	300	LS48	55					
6805	670	Z80SIO-8	300	LS48	55					
6808	820	Z80SIO-8	300	LS48	55					
6809	820	Z80SIO-8	300	LS48	55					
6810	115	Z80SIO-8	300	LS48	55					
6820	115	Z80SIO-8	300	LS48	55					
6821	115	Z80SIO-8	300	LS48	55					
6840	395	Z80SIO-8	300	LS48	55					
6843	£12	Z80SIO-8	300	LS48	55					
6845	720	Z80SIO-8	300	LS48	55					
6847	720	Z80SIO-8	300	LS48	55					
6850	135	Z80SIO-8	300	LS48	55					
6852	255	Z80SIO-8	300	LS48	55					
6875	500	Z80SIO-8	300	LS48	55					
74C522	260	Z80SIO-8	300	LS48	55					
8080A	450	Z80SIO-8	300	LS48	55					
8085A	450	Z80SIO-8	300	LS48	55					
81LS95	85	Z80SIO-8	300	LS48	55					
81LS96	85	Z80SIO-8	300	LS48	55					
81LS97	85	Z80SIO-8	300	LS48	55					
81LS98	85	Z80SIO-8	300	LS48	55					
8195	120	Z80SIO-8	300	LS48	55					
8173	425	Z80SIO-8	300	LS48	55					
8202	£25	Z80SIO-8	300	LS48	55					
8212	150	Z80SIO-8	300	LS48	55					
8214	425	Z80SIO-8	300	LS48	55					
8215-300	70	Z80SIO-8	300	LS48	55					
8216	180	Z80SIO-8	300	LS48	55					
8224	250	Z80SIO-8	300	LS48	55					
8226	250	Z80SIO-8	300	LS48	55					
8228	250	Z80SIO-8	300	LS48	55					
8251	320	Z80SIO-8	300	LS48	55					
8253	799	Z80SIO-8	300	LS48	55					
8255	295	Z80SIO-8	300	LS48	55					
8256	£33	Z80SIO-8	300	LS48	55					
8257	800	Z80SIO-8	300	LS48	55					
8271	£36	Z80SIO-8	300	LS48	55					
8284	320	Z80SIO-8	300	LS48	55					
8502	99	Z80SIO-8	300	LS48	55					
8726A	99	Z80SIO-8	300	LS48	55					
8727	120	Z80SIO-8	300	LS48	55					
8728A	120	Z80SIO-8	300	LS48	55					
8731	90	Z80SIO-8	300	LS48	55					
8795N	90	Z80SIO-8	300	LS48	55					
8797N	90	Z80SIO-8	300	LS48	55					
9364AP	550	Z80SIO-8	300	LS48	55					
AM26LS33C	125	Z80SIO-8	300	LS48	55					
AM26LS32A	125	Z80SIO-8	300	LS48	55					
AY-3-1015	300	Z80SIO-8	300	LS48	55					
AY-5-1013	300	Z80SIO-8	300	LS48	55					
AY-5-1350	600	Z80SIO-8	300	LS48	55					
AY-5-2376	600	Z80SIO-8	300	LS48	55					
COM8017	275	Z80SIO-8	300	LS48	55					
COM8196	700	Z80SIO-8	300	LS48	55					
DM8131	275	Z80SIO-8	300	LS48	55					
DP8304N	250	Z80SIO-8	300	LS48	55					
DS3691N	320	Z80SIO-8	300	LS48	55					
DS89L5120N	275	Z80SIO-8	300	LS48	55					
FD1761	£15	Z80SIO-8	300	LS48	55					
FD1771	£18	Z80SIO-8	300	LS48	55					
FD1791	£22	Z80SIO-8	300	LS48	55					
FD1793	£28	Z80SIO-8	300	LS48	55					
FD1795	£28	Z80SIO-8	300	LS48	55					
FD1797	£28	Z80SIO-8	300	LS48	55					
INS6402	360	Z80SIO-8	300	LS48	55					
INS6502N	109	Z80SIO-8	300	LS48	55					
INS8154N	£10	Z80SIO-8	300	LS48	55					
MC1488	£10	Z80SIO-8	300	LS48	55					
MC1488	55	Z80SIO-8	300	LS48	55					
MC1489	74	Z80SIO-8	300	LS48	55					
MC14411	675	Z80SIO-8	300	LS48	55					
MC14412	775	Z80SIO-8	300	LS48	55					
MC3447P	315	Z80SIO-8	300	LS48	55					
MK3886-2M	£7	Z80SIO-8	300	LS48	55					
MM5280D	695	Z80SIO-8	300	LS48	55					
MM58174	855	Z80SIO-8	300	LS48	55					
MM74C922	855	Z80SIO-8	300	LS48	55					

WATFORD'S UNIVERSAL MICRO EXPANSION SYSTEM

Designed by Watford Electronics, this extremely versatile and economical Expansion System as published in E.T.I., starting from Dec. 1981 issue, offers a low cost flexible expansion system for ZX81, UK101, SUPERBOARD, ACORN ATOM, PET, TANGERINE, etc.

The Motherboard (interfaces with the computer) has capacity to accept up to five daughter cards and can be paralleled for even more daughter cards.

All PCBs are of computer grade finish and are supplied in kit form.

Just look at the Expansion possibilities. **MOTHERBOARD** — Accepts up to five daughter cards. Full kit: £36.50

SOUND CARD — Utilising up to three AY-3-8910 sound chips (one supplied with the kit). Full kit: £24.95

PIO CARD — Using two 6520 PIA chips, this Board offers Centronics parallel printer driver, digital to analogue converter and a host of other output facilities. Full kit: £19.95

PROM PROGRAMMER — This simple but extremely useful card can flow 2716r single rail EPROMS. (2732) Full kit: £25.95

PROM CARD — PCB cards for housing four 2716 or two 2732 EPROMS. (4 x 2716) Full kit: £11.95 (2 x 2732) Full kit: £11.75

RAM CARD — BK RAM card. Accepts 16 x 2114 RAMs. Board is supplied fully populated. Full kit: £28.50 (NB PCBs may be bought separately).

WATFORD'S Ultimate MON Monitor IC.

A 4K Monitor Chip specially designed to produce the best from your Superboard Series I & II, Enhanced Superboard & UK 101. As reviewed by Dr. A.A. Berk in Practical Electronics, June 1981. Price only £12

NEW SEIKOSHA GP100A



Unihammer Printer, gives normal and double width characters as well as dot resolution graphics 10" Tractor feed. Parallel interface standard. £185 + p&p

SOFTY II

"TO BOLDLY GO WHERE NO ONE HAS BEEN BEFORE"

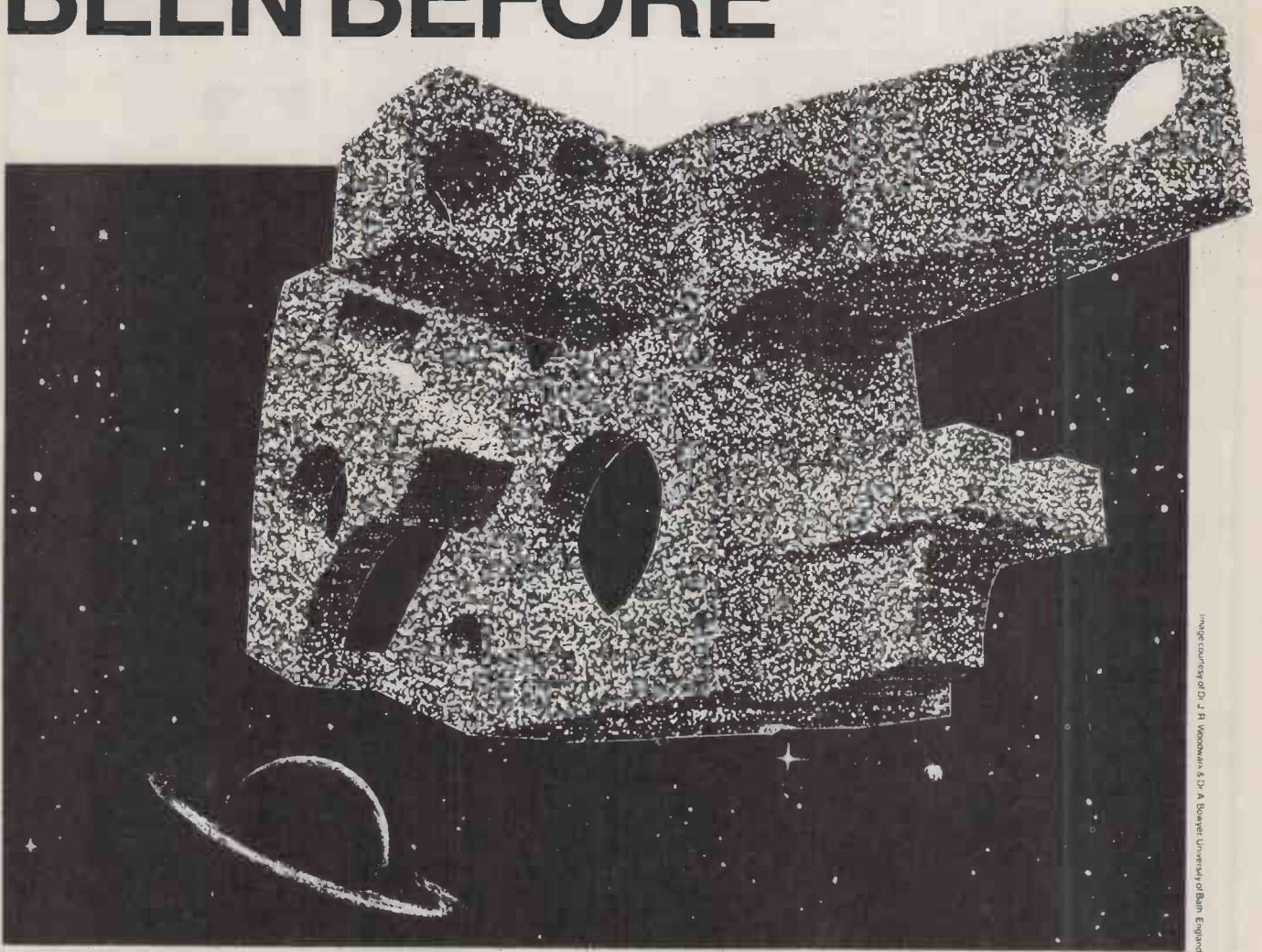
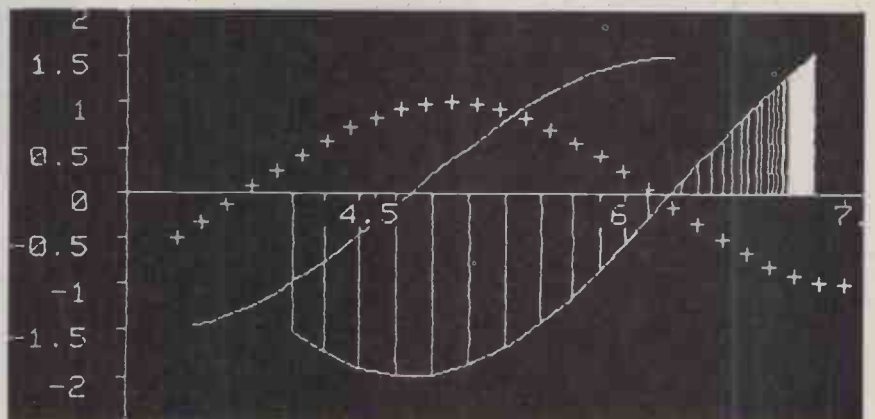
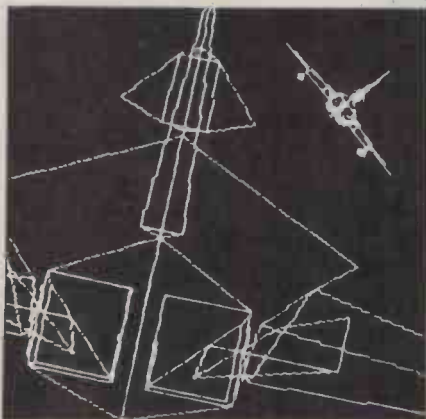

Image courtesy of Dr. J. R. Woodcock & Dr. A. Bowyer, University of Bath, England



Above left. 3D wire objects in true perspective.
Top picture. Display of three-dimensional solid object.

Above right. Bar charts, histograms and scatter plots.

MICRONEX Original Equipment

Graphics packages for microcomputers and intelligent terminals
In service worldwide in Industry, Science, Education and Commerce

HIGH RESOLUTION GRAPHICS PACKAGES FOR SUPERBRAIN 1+2

The Micronex 128S £675.

High resolution display generator 2 pages x 1024 x 512 pixels

Hardcopy printer output facility £55.

IDS PT560 & Prism 132 printer drivers

Digitiser pad input facility £55.

Graphics primitive handlers for Summagraphics Bit-Pad and Houston Hi-Pad

PLUS suite of 5 software packages £395.

For Pascal, FORTRAN, BASIC

under CP/M include—

Graphics Primitives. Graph Plotter. Surface Plotter in 3D with true-perspective and hidden-line removal. 3D graphics for wire-frame objects. Tektronix 4010/4014 graphics terminal emulator

FAST ACCESS

The exclusive Micronex VU-DISK £115.

Lets you use your Micronex 128S Pixelplotter just like a very-fast-access 128K byte disk under CP/M.

Eliminates time consuming disk-drive activity.

Up to three times faster for sorting, merging, compilation, assembly.

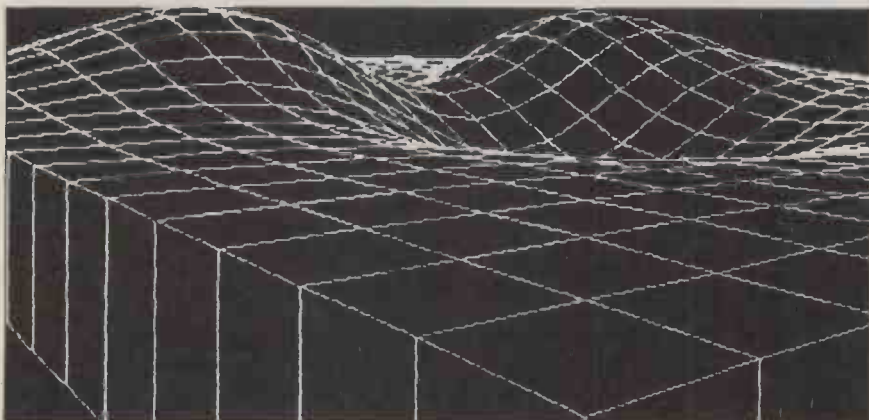
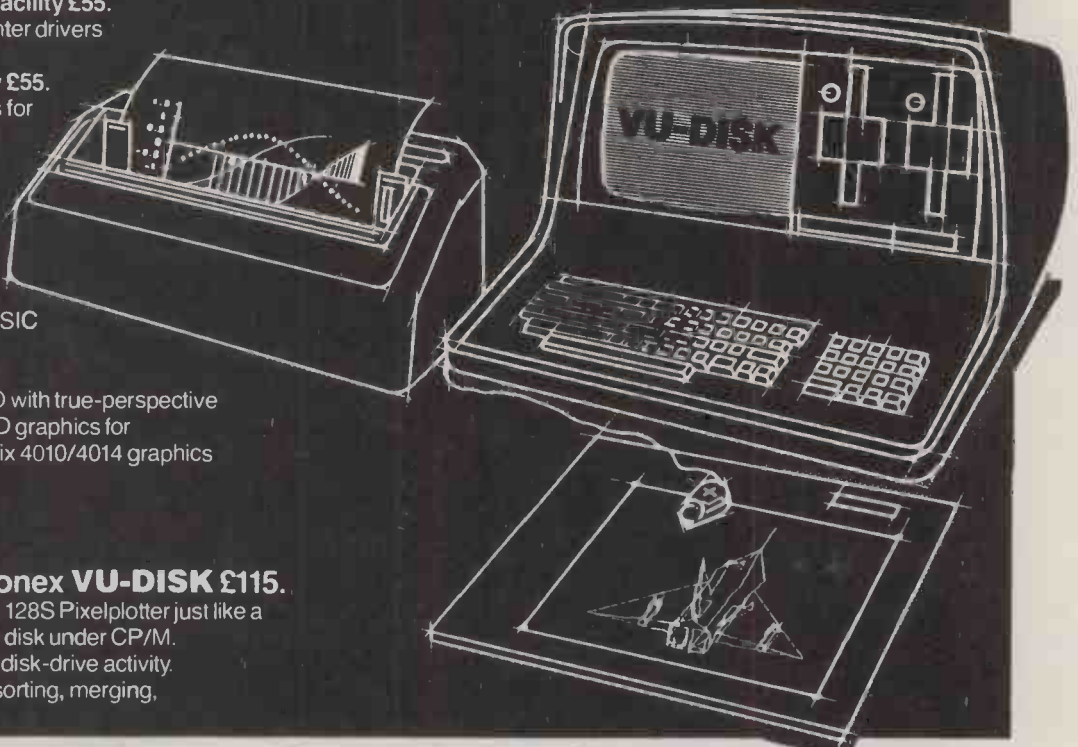

Above picture. Close-up detail of high resolution graphics surface plot in 3D with true perspective and hidden-line removal, viewed from any angle.

I would like to know more about Micronex graphics products, please send technical information and local dealer address.

Name

Title

Organisation

Address

Telephone

OEM

Industrial

Distributor/dealer

Educational

All prices quoted are exclusive of VAT

Advertising Design by Robinson Lyncey Bath & London Ref M6/82 England

MICRONEX Supportware

Micronex Limited. Harford Square Chew Magna, Bristol BS18 8RA England. Telephone (027 589) 3042

USA & Canada: Maxtek Inc. XCEL™ Graphics. Telephone Los Angeles (213) 320-6604

Micronex, Pixelplotter, VU-Disk, Supportware are trade marks of Micronex Limited. Superbrain is registered by Interdec Inc. Tektronix is registered by Tektronix Inc.

● Circle No. 104

NASCOM MEANS SOLUTIONS NASCOM MEANS PERFORMANCE

Nascom have come a long way since their acquisition by Lucas. With the knowledge of over 30,000 units already in the field you can buy with confidence from NASCOM.

PRODUCTS:

We have kits, built and tested boards, and our fully assembled and tested NASCOM 3 system with a full choice of configuration either cassette or disc based. Alternative operating systems include NAS DOS and CP/M.

SOFTWARE:

We have a team of programmers who are writing software and courseware especially for UK educational business and domestic users.

FREE ADVICE:

We have appointed experts to advise on the specialist use of micro computers in U.K. schools, homes or businesses.

BACK-UP:

We have a nationwide dealer network giving full sales back-up and after sales service. From our head office we have a service line to sort out any problems.

SYSTEM EXPANSION:

NASCOM machines are designed to grow with users. Easily and simply NASCOM systems can be expanded by adding extra modules to the basic system.



Learn more about NASCOM now. Complete the coupon for further information and a full list of dealers.

LUCAS LOGIC LIMITED
NASCOM MICROCOMPUTERS DIVISION,
Welton Road, Wedgcock Industrial Estate,
Warwick CV34 5PZ, England

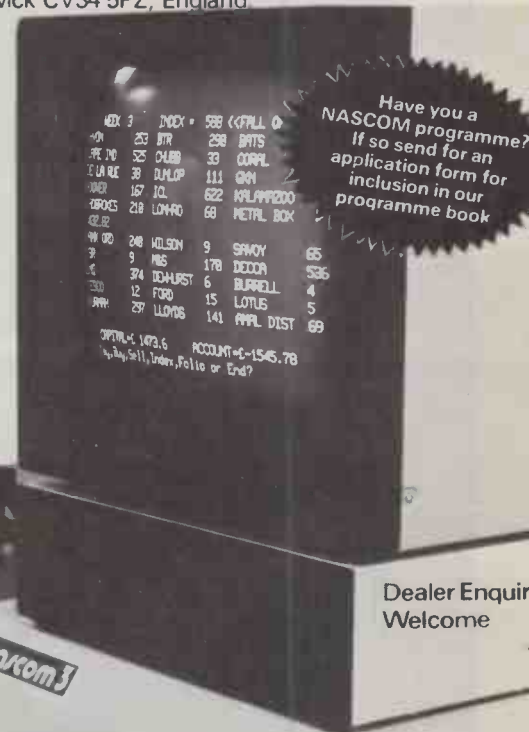

Dealer Enquiries Welcome

£1,548 + VAT
A typical system as shown consisting of a Nascom 3 (48K), dual disks, monitor, and printer is available from your dealer now.

authorized stockists



semicomps
NORTHERN LIMITED

Semicomps Northern Ltd.
East Bowmont Street,
Kelso, Roxburghshire Tel (0573) 24366

Eley Electronics

Eley Electronics, 100/104 Beatrice Road,
(off Fosse Road North), Leicester. Tel: 0533 871522

MID-SHIRE'S COMPUTER CENTRE

68 Nantwich Road, Crewe, Cheshire
Tel: (0270) 211086

ELECTRICAL ELECTRONIC & MICROCOMPUTING
RETAIL & REPAIR

18 Station Road Lower Parkstone
Poole Dorset BH14 8UB
Tel Parkstone (0202) 746555



**PARKSTONE
ELECTRICS**

Micro Comms

Amateur radio C.B. radio
Electronics Computers

372-374 George Street Aberdeen
Telephone: 0224 633385

JPS

9 East Street, Colne,
Nr. Huntingdon, Cambs.
Tel: Ramsey (0487) 840710
Contact Paul Jephcott



SRS MICROSYSTEMS

161 Bramley Road, Oakwood,
London N14
Telephone: 01-363 8060

58 Battersea Rise,
Clapham Junction
London SW11 1HH
Tel: 01-674 1205
01-675 4557

**OFF
Records**

SKYTRONICS LTD.

2 NORTH ROAD, THE PARK, NOTTINGHAM NG7 1AG
TELEPHONE (0602) 45053



**In the heart
of the Nascom
country lies
Business & Leisure**

**Business & Leisure
Micro Computers**

We specialise in tailoring
systems to your specific
requirements.

16 The Square, Kenilworth, CV8 1EB.
Tel: Kenilworth (0926) 512127



Stationstraat,
6241 CL,
Bunde (L),
Netherlands.
Tel: 043 641147

CHRISALID for **nascom**

systems & software

tel 74569

13 High Street *BERKHAMSTED*

MICRO-PRINT LTD

59 Church Street, Stoke-on-Trent, ST4 1DQ.
Tel: (0782) 48348

Newburn Electronics

Ballycarry, Co. Antrim.
Whitehead 78330

C.I.E.L.

**Computer Interfacing
& Equipment Limited**

19 ROSEBURN TERRACE
EDINBURGH EH12 5NG
SCOTLAND
Tel: 031-337 5611

OTHER NASCOM PRODUCTS

Kits from £125 + VAT
Built from £285 + VAT
Systems from £399 + VAT

To Lucas Logic Ltd., Nascom Microcomputers Division, Welton Road,
Wedgnock Industrial Estate, Warwick CV34 5PZ, England

Please send:

Literature Dealer List Prog. Book Form

Name

Position

Establishment

Address

.....

Tel. No

PC5

Lucas Logic

Two for price of

What would you expect to pay for a printer that *either* gave you impressive DP speed or high WP quality?

For anything between £1500 - £2200 you can purchase a printer which will give you superb DP speeds but no real WP quality.

On the other hand, in a similar price range, you can achieve immaculate WP quality, but miss out on the DP speed.

Now, in a special summertime offer, CPU Peripherals are offering TWO high performance and quality printers for the price you would expect to pay for ONE!



**For less than
the cost of a quality matrix
or daisy-wheel CPU bring you two
outstanding printers for only £1599***

CPU Peripherals, Rodd Industrial Estate, Govett Avenue, Shepperton, Middlesex, TW17 8AQ.
Telephone: (09322) 46433/4/5/6 Telex: 922637

the one

!!!?

CPU PERIPHERALS



The Prima 165

British built in our Woking factory to a proven design, this outstanding dot matrix printer offers:

- 165 cps bi-directional printing
- 80 cps correspondence quality print
- 9 x 9, 96 character sets with lc descenders
- Downline loading of special character sets
- Pin addressable graphics
- Tractors (1 + 5 copies)
- Superscript/Subscript
- 7 channel VFU
- Serial and parallel interface (switchable)
 - Buffering up to 3K
 - Low noise (58 db)

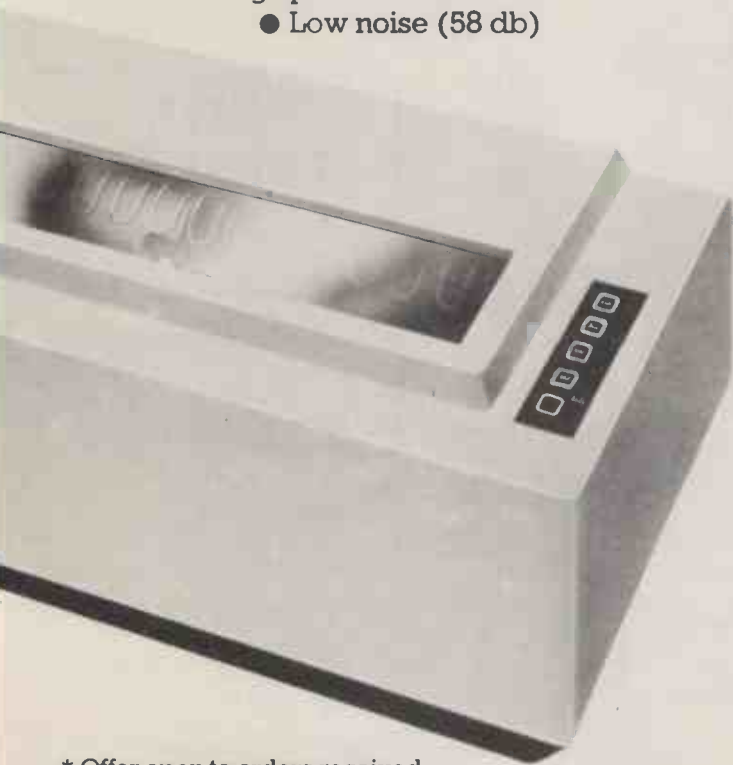

* Offer open to orders received by August 31st 1982.
Price exclusive of carriage and VAT.

● Circle No. 106

The new Daisywriter 2000

A most advanced microprocessor controlled serial impact printer giving quality output QUIETLY.

- up to 20cps bi-directional
- 96 character interchangeable cartridge wheel element
- snap on/off tractor and sheet feed options
- 4 switchable interfaces - EIA RS-232C/CCITT V.24, ETX/ACK and DC1/DC3 (XON/OFF) Centronics 8 bit parallel, TTL logic levels Current loop, 20 ma \pm VDC IEEE-488, 8 bit ASCII parallel
- IBM Selectric type cassette film
- 1 + 5 Copies
- 16K - 48 Kbyte
- Character buffer
- 10, 12, 15 characters per inch
- Forward/reverse paper movement
- Automatic proportional spacing
- Paper-out sensor
- Forms length control
- Horizontal and vertical tab

I wish to take advantage of this unique introductory offer.
 I enclose my official order Please send me details and arrange for a CPU representative to contact me.

Name _____
Company _____
Address _____
Telephone _____

MPI MICRO COMPUTER PRODUCTS

INTERNATIONAL LTD.

SOFTWARE FOR CP/M COMPUTERS

	Software & Manual	Manual Only		Software & Manual	Manual Only		Software & Manual	Manual Only
BYROM SOFTWARE			MICRO-AP			OSBORNE & ASSOCIATES		
BSTAM—Utility to link one micro-computer to another also using BSTAM	£105.55	£6.66	SELECTOR V	£305.55	£27.77	ACCOUNTS PAYABLE & ACCOUNTS RECEIVABLE	£50	£15
BSTMS—Utility to link a micro to a mini or mainframe	£105.55	£12.22				GENERAL LEDGER	£50	£15
CP/M USER LIBRARY			MICROFOCUS			PHOENIX SOFTWARE ASSOCIATES (For Z80 only)		
51 Volumes—Price per volume			CIS COBOL version 4.5	£425	£25	PLINK—Disc to disc link loader	£80.00	£16.66
8" disc (one volume per disc)	£5.00		FORMS (new version)	£100	£15	PASM—Macro Assembler	£80.00	£16.66
5" disc (one volume per 2 discs)	£10.00					PEDIT—Line editor with Macros	£80.00	£16.66
Index	£2.00		MICROLOGY			BUG—Very powerful debug	£80.00	£16.66
DIGITAL RESEARCH			MICROPRO INC.			PDEVELOP Package with all the above	£214.44	£36.66
CBASIC v 2.08	£72.22	£13.80	FTNUMB (FORTRAN-80 RENUMBER & REFORMATTER)	£50.00		PLINK—2 Overlay Link Loader	£205.55	£16.66
MPM 1.1	£216.66	£22.22	MICROTECH EXPORTS			STRUCTURED SYSTEMS (All converted to UK Standard)		
MPM 2.0	£272.22	£33.33	REFORMATTER			SALES LEDGER	£388.88	£22.22
CP/M86	£161.11	£30.00	CPM ← IBM	£108.88	£18.88	PURCHASE LEDGER	£388.88	£22.22
CP/M 2.2	£97.22	£22.22	CPM ↔ DEC	£108.88	£18.88	NOMINAL LEDGER	£388.88	£22.22
CP/NET	£119.44	£15.55	MICROSOFT INC.			STOCK CONTROL	£388.88	£22.22
SID	£47.22	£15.55	BASIC-80 5.21	£205.55		LETTERIGHT	£105.55	£12.22
ZSID	£61.11	£15.55	BASIC Compiler 5.3	£227.77		ANALYST (File management Reporting System)	£138.88	£12.22
MAC	£58.33	£15.55	FORTRAN-80 3.43	£288.88		NAD (Name and Address selection system)	£61.11	£12.22
TEX	£61.11	£15.55	COBOL-80 4.01	£422.22		QSORT	£61.11	£12.22
DESPOOL	£29.44	£6.66	M/SORT 1.01	£83.33		SUPERSOFT INC.		
PL/1-80	£297.22	£30.00	EDIT-80 2.02	£72.22		DIAGNOSTICS 1	£50.00	£10.00
BT-80	£155.55	£22.22	MACRO-80 3.43	£116.66		TERM	£80.00	£7.77
CB-80	£294.44	£19.44	MULISP 2.10	£116.66		TDL SOFTWARE (Technical Design Labs)		
XLT-86	£88.88	£7.22	MUMATH 2.10	£144.44		BUSINESS BASIC	£80	
FOX & GELLER			MT MICROSYSTEMS			ZTEL (Text Editing Lang.)	£35	
QUICKSCREEN	£97.22	£13.33	PASCAL MT+ 5.5	£194.44	£27.77	LINKER	£35	
INFORMATION UNLIMITED			PASCAL MT+ 5.5 with SPP	£280.55	£55.55	ANTHONY ASHPITEL TYPING TUTORS		
WHATSIT (Database Management System)	£80.00		Library Sources	£122.22		BASIC VERSION	£50	
KLH SYSTEMS			Speed Programming Pkge. (Softbus)	£138.88	£27.77	BUSINESS VERSION	£125	£25
Spooler for CPM systems v3.0	£77.17	£6.66	MPI LTD.			DIGITAL RESEARCH		
MAGIC CIRCLE SOFTWARE			FORTH	£80.00	£22.00	CB-80	£265	£18
CPM.SIM	£133.33		PAYROLL	£500	£15	XLT-86	£80	£7
MEDIA AND FORMATS			SALES LEDGER	£200	£15	MICROFOCUS LTD.		
Altos	A1	CPT 8000	PURCHASE LEDGER	£200	£15	ANIMATOR	TBA	
APPLE CP/M-80 13 Sector	RG	Cromemco System 3	NOMINAL LEDGER	£200	£15	FILESHARE	TBA	
APPLE CP/M-80 16 Sector	RR	Cromemco System 2 SD/SS	INCOMPLETE RECORDS	£1200	£20	M.P.I. LTD.		
Blackhawk Micropolis Mod II	Q2	Cromemco System 2 DD/SS	WHATSIT	£80.00		MATHS PACK	£120	
British Micros Mimi	RK	CSSN Backup	FT NUMB	£50.00		STATS PACK	£120	
California Computer Sys 8 in	A1	Datapoint 1550/2150	ORDER INFORMATION					
CDS Versatile 4	Q2	Dec VT 180 SDD	When ordering CP/M software please specify the format you require. All software items are subject to VAT. Manuals, when purchased separately, are not subject to VAT. Please add £4.00 for postage, packing and insurance on each item purchased. For overseas please add £6.50 per item. Most software in this advertisement is available from stock and a 72 hour return service is thereby offered on most prepaid orders. These details and prices are all current as of June 1982. Our prices reflect an exchange rate of U.S. \$1.80 to £1.00. Should the exchange rate vary by more than 5 cents, a surcharge may be added or a discount given. All payments must be in Sterling and drawn against a U.K. bank.					
Columbia Data Products 8 in	A1	Delta Systems	MAIL ORDER - TELEPHONE ORDER - VISIT - Send Cash, Cheque, Postal Order, IMO, Access or Barclaycard/Visa number to Microcomputer Products International Ltd., Room PC, 11 Cambridge House, Cambridge Road, Barking, Essex IG11 8NT.					
Comart Communicator CP50	P2	Dynabyte DB8/4						
Comart Communicator CP100	P2	Exidy Sorcerer + CP/M-80						
Comart Communicator CP200	P2	Exidy Sorcerer + Exidy CP/M-80/8"						
Comart Communicator CP500	P2	EXO						
Compal-80	Q2	Gemini Galaxy I						
		Heath H8 + H47						
		Hewlett-Packard 125.8in						
		ICOM 3712						
		IMSAI VDP-80						
		Industrial Microsystems 5000						
		Intel MDS SD						
		Interlec Superbrain SDD						
		Interlec Superbrain QD						
		ISC Intercolor 8063/8360/8963						
		ITT 3030 DSDD						
		Micromation						
		Micropolis Mod II						
		Morrow Disc						
		Mostek						
		Multi-Tech 1						
		Multi-Tech 2						
		Micromation						
		Micropolis Mod II						
		Morrow Disc						
		Mostek						
		Nascom (Gemini Drives SDD)						
		Nascom (Gemini Drives DSSD)						
		Nascom/Lucas						
		NCR 8140/9010						
		NNC-80						
		NNC-80W						
		North Star Advantage						
		North Star Horizon SSSD						
		North Star Horizon SSDD						
		North Star Horizon QD (MPI CP/M)						
		North Star Horizon QD						
		(Other CP/M)						
		Nylac Micropolis Mod II						
		Osborne-I						
		Pertec PCC 2000						
		Rade 1000 SDD						
		Rade 1000 DSDD						
		Rair Black Box						
		Research Machines 5.25in						
		Research Machines 8in						
		SD Systems 5.25in						
		SD Systems 8in						
		Shelton Signet						
		Spacebyte						
		Tarbell 8in						
		TEI 8in						
		Televideo DSDD						
		Toshba T200 DSDD						
		TRS-80 Model I + Shuffle-board 8in						
		TRS-80 Model II						
		Vector MZ						
		Vector Systems 2800						
		Vector Systems B						
		Vector VIP						
		Xerox 820 5.25in						
		Xerox 820 8in						

NEW PRODUCTS

ANTHONY ASHPITEL TYPING TUTORS		
BASIC VERSION	£50	
BUSINESS VERSION	£125	£25
DIGITAL RESEARCH		
CB-80	£265	£18
XLT-86	£80	£7
MICROFOCUS LTD.		
ANIMATOR	TBA	
FILESHARE	TBA	
M.P.I. LTD.		
MATHS PACK	£120	
STATS PACK	£120	

MEDIA AND FORMATS

Altos	A1	CPT 8000	A1	Industrial Microsystems 8000	A1	Nascom/Lucas	N1	SD Systems 5.25in	R3
APPLE CP/M-80 13 Sector	RG	Cromemco System 3	A1	Intel MDS SD	A1	NCR 8140/9010	A1	SD Systems 8in	A1
APPLE CP/M-80 16 Sector	RR	Cromemco System 2 SD/SS	R6	Interlec Superbrain SDD	RK	NNC-80	A1	Shelton Signet	RK
Blackhawk Micropolis Mod II	Q2	Cromemco System 2 DD/SS	RX	Interlec Superbrain QD	RS	NNC-80W	A1	Spacebyte	A1
British Micros Mimi	T1	CSSN Backup	T1	ISC Intercolor 8063/8360/8963	A1	North Star Advantage	P2	Tarbell 8in	A1
California Computer Sys 8 in	RV	Datapoint 1550/2150	A1	ITT 3030 DSDD	R1	North Star Horizon SSSD	P1	TEI 8in	A1
CDS Versatile 4	A1	Dec VT 180 SDD	A1	Micromation	A1	North Star Horizon SSDD	P2	Televideo DSDD	S5
Columbia Data Products 8 in	A1	Delta Systems	A1	Micropolis Mod II	Q2	North Star Horizon QD (MPI CP/M)	P3	Toshba T200 DSDD	SF
Comart Communicator CP50	Q2	Dynabyte DB8/4	A1	Morrow Disc	A1	North Star Horizon QD		TRS-80 Model I + Shuffle-board 8in	A1
Comart Communicator CP100	Q2	Exidy Sorcerer + CP/M-80	Q2	Mostek	A1	(Other CP/M)	P2	TRS-80 Model II	A1
Comart Communicator CP200	A1	Exidy Sorcerer + Exidy CP/M-80/8"	A1	Multi-Tech 1	Q2	Nylac Micropolis Mod II	Q2	Vector MZ	Q2
Comart Communicator CP500	A1	EXO	A1	Multi-Tech 2	Q2	Osborne-I	RP	Vector Systems 2800	A1
Compal-80	P2	Gemini Galaxy I	NI	Micromation	Q2	Pertec PCC 2000	A1	Vector Systems B	Q2
	P2	Heath H8 + H47	A1	Micropolis Mod II	Q2	Rade 1000 SDD	RL	Vector VIP	Q2
	P2	Hewlett-Packard 125.8in	A1	Morrow Disc	A1	Rade 1000 DSDD	RE	Xerox 820 5.25in	S6
	P2	ICOM 3712	A1	Mostek	A1	Rair Black Box	RN	Xerox 820 8in	A1
	P2	IMSAI VDP-80	A1	Nascom (Gemini Drives SDD)	R3	Research Machines 5.25in	A1		
	Q2	Industrial Microsystems 5000	RA	Nascom (Gemini Drives DSSD)	R7	Research Machines 8in			

2

MORE GOOD REASONS TO RING 01-591 6511

Simplicity Plus Speed

CB-80™

Programming Language

CB-80 is a native code compiler of the CBASIC language. As a direct enhancement of CBASIC, CB-80 offers all the features of CBASIC plus the speed and versatility of a compiler. Other enhancements include support of 32K byte strings, external multiple line functions, run-time error trapping and extended file handling capabilities. CB-80 also includes the LK-80™ linker. LK-80 easily links assembler routines into CB-80 programs and is used to create overlay modules. CB-80 supports the multi-user operating system, MP/M II.

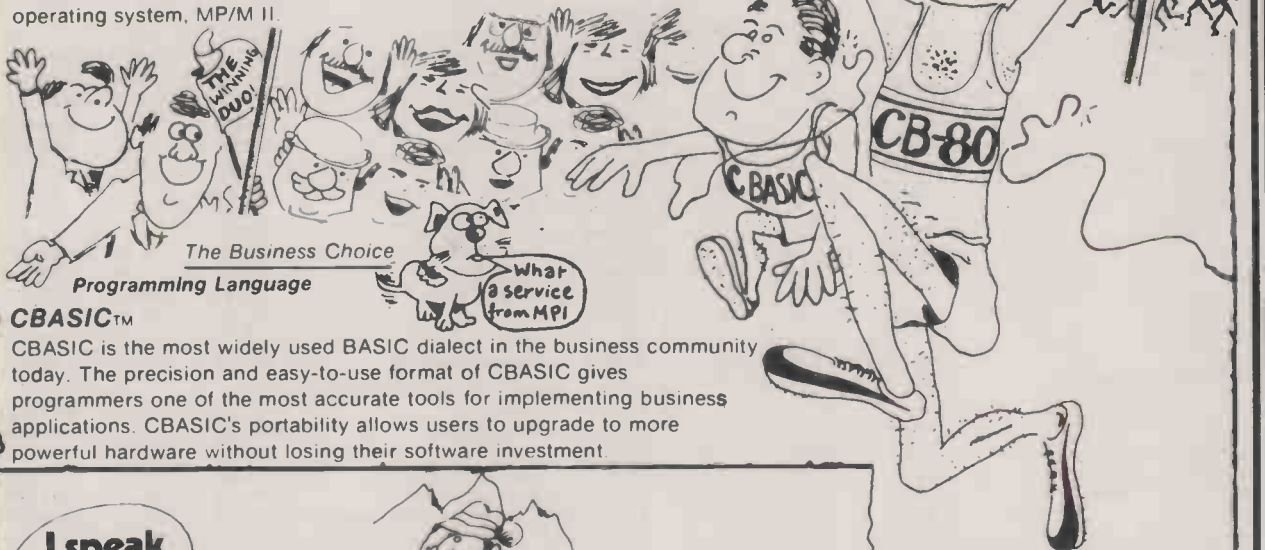
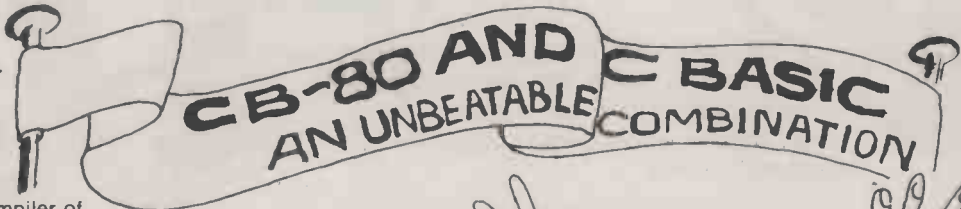

The Business Choice

Programming Language

CBASIC™

CBASIC is the most widely used BASIC dialect in the business community today. The precision and easy-to-use format of CBASIC gives programmers one of the most accurate tools for implementing business applications. CBASIC's portability allows users to upgrade to more powerful hardware without losing their software investment.

MAIL ORDER
TELEPHONE
CREDIT CARD ORDER
• VISIT •

I speak 8080

I speak 8086

We all speak the same Language

The Investment Saver

XLT86™

Assembly Language Translator

XLT86 is an aid to software and hardware manufacturers wanting to convert their existing 8-bit 8080 programs to the 16-bit 8086 microcomputer. XLT86 allows a user to translate an 8080 assembly source code file into an optimized 8086 assembly source code file, while preserving all existing labels, comments, and symbols from the 8080 source program. This feature reduces the amount of time required to develop and support 8086 code. XLT86 uses extensive program flow analysis, to perform the translation. XLT86 is written in Subset G of PL/1.

Trade Enquiries Welcome



Apple, Atari and NEC at hard-checked prices*

*Hardware or software, you don't have to shop around. We continually check all our prices and we're certain they are as competitive as you will find anywhere.



	NET	VAT	TOTAL
PACKAGE SYSTEMS			
Apple Executive System	1950.00	292.50	2242.50
Apple Top Secretary System	2150.00	322.00	2472.50
Apple Education System	1425.00	213.75	1638.75
APPLE HARDWARE			
Apple II 48K	599.00	89.85	688.85
.16K Add on	45.00	6.75	51.75
Disk Drive with Controller (16 sec)	345.00	51.75	396.75
Disk Drive without Controller	275.99	41.25	316.25
ACCESSORIES			
Programmers Aid 1	25.00	3.90	29.90
Auto Start ROM Pack	33.00	4.95	37.95
Graphics Tablet	399.00	59.85	458.85
Appletel System	525.00	78.75	603.75
TV Modulator	14.00	2.10	16.10
INTERFACE CARDS			
Prototype/Hobby Card	12.00	1.80	13.80
Parallel Printer Card	79.00	11.85	90.85
Communications Card	100.00	15.00	115.00
High Speed Serial Card	90.00	13.50	103.50
Centronics Card	100.00	15.00	115.00
Integer Card	90.00	13.50	103.50
Language Card	95.00	14.25	109.25
Controller Card	95.00	14.25	109.25
Eurocolour Card	65.00	9.75	74.75
IEEE - 48 Card	200.00	30.00	230.00
16K RAM Card (48K to 64K)	60.00	9.00	69.00
SOFTWARE			
Disk Utility Pack	12.00	1.80	13.80
Apple Post Program	27.00	4.05	31.05
The Shell Games	15.00	2.25	17.25
Elementary My Dear Apple	16.00	2.40	18.40
Apple Bowl Diskette	13.00	1.95	14.95
3.3 Operating System	34.00	5.10	39.10
DOS 3.3 Tool Kit	41.00	6.15	47.15
Apple Writer 1.1	34.00	5.10	39.10
Stellar Invader	13.00	1.95	14.95
Apple Plot	34.00	5.10	39.10
Apple Adventure	19.00	2.85	21.85
APPLE DISTRIBUTED SOFTWARE			
The Go Between (Centronics)	26.50	3.98	30.48
Micro Modeller	375.00	56.25	431.25
Visicalc 3.3	105.00	15.75	120.75
VisiFile	135.00	20.25	155.25
VisiPilot	95.00	14.25	109.25
VisiTrend/VisiPilot	135.00	20.25	155.25
VisiTerm	80.00	12.00	92.00
VisiDex	105.00	15.75	120.75
Desktop Plan II	105.00	15.75	120.75
LANGUAGES			
Pascal Language System	225.00	33.75	258.75
Apple Pilot	75.00	11.25	86.25
Apple Fortran	95.00	14.25	109.25
CIS Cobol with Forms -2	410.00	61.50	471.50

PRINTER & ACCESSORIES

	NET	VAT	TOTAL
Silentype Printer	170.00	25.50	195.50
10 Rolls Thermal Paper	28.00	4.20	32.20

VIDEO MONITORS

	NET	VAT	TOTAL
BMC 12" Green Screen	120.00	18.00	138.00
9" Black & White Monitor	100.00	15.00	115.00
Cables	5.00	0.75	5.75

OTHER ITEMS

	NET	VAT	TOTAL
Z80 Softcard	170.00	25.50	195.50

ATARI

400 16K Computer	173.87	26.08	199.95
400 16K Computer (with BASIC)	217.30	32.60	249.90
800 16K Computer	391.26	58.69	449.95
800 16K Computer (with BASIC)	434.70	65.20	499.90
822 Thermal Printer	200.00	30.00	230.00
825 80 Column Printer	400.00	60.00	460.00
850 RS 232 Interface	110.00	16.50	126.50
16K Ram Upgrade	52.13	7.82	59.95
Conversational French	28.26	4.24	32.50
Conversational German	28.26	4.24	32.50
Conversational Spanish	28.26	4.24	32.50
Conversational Italian	28.26	4.24	32.50
Assembler Editor Rom	30.39	4.56	34.95
Visicalc	105.00	15.75	120.75
Word Processor	78.22	11.73	89.95
Video Computer System	69.56	10.43	79.99

NEW - N.E.C. PC 8000 SERIES

PC 8001 Keyboard	500.00	75.00	575.00
PC 8011 Expansion Unit	407.83	61.17	469.00
PC 8012 I/O Unit	346.96	52.04	399.00
PC 8023 Dot Matrix Printer	326.08	48.91	375.00
PC 8031 Floppy Disc Drive	543.48	81.52	625.00
PC 8041 12" Green or Amber Monitor	129.57	19.43	149.00
PC 8043 12" High Resolution CRT Colour Monitor	477.39	71.61	549.00

HARDWARE GUARANTEE

All advertised products are guaranteed one year from date of purchase against defects in materials and workmanship.

During the guarantee period, Metrotech will repair or replace, at no extra charge, components that prove defective - providing that the product is returned, shipping or postage prepaid, stating when bought and enclosing proof of purchase.

This guarantee does not apply if, in the opinion of the Company, the product has been damaged by accident, misuse or misapplication.

CONDITIONS OF BUSINESS.

We accept cheques or Access, Barclaycard, American Express and Diners Club Cards. All prices, specifications and terms are subject to change without notice at the discretion of the management. All offers subject to availability.

Prices correct at time of going to press. E. & O.E.

Hardware Post and packaging subject to confirmation.



New CP/M software at hard to beat prices



DIGITAL RESEARCH

BASIC II
Commercial/Disk Extended Basic **£75/£30**

NEW CB 80. Ultra fast Basic compiler. All the features of C Basic plus the speed and versatility of a compiler. 32K Byte strings, external multiple line functions, run time error trapping and extended file handling capabilities. **£275/£30**

NEW PL/1-80. A standard structured commercial applications programming language. Saves design time. Minimises debugging and maintenance problems. Designs high quality output with picture specifications. Includes the compiler, run-time library, lineage editor and relocating macro-assembler. **£275/£30**

MICROPRO INC.

WORDSTAR 3XX. New features: column move capabilities, horizontal scrolling up to 240 columns and even clearer menus. **£195/£30**

MAILMERGE 3XX(optional) **£55/£10**

DATASAR Powerful data entry, retrieval and up-date system. **£150/£30**

SUPERSORT 1. Combines high performance and operational flexibility to perform sorting, merging and record selection functions. **£105/£20**

WORDMASTER Superior text editor. **£105/£20**

NEW CALCSTAR. This sophisticated but easy to use calculating and planning tool is Micropro's new spread sheet and financial modelling program. **£120/£30**

COMPSOFT

NEW COMPSOFT DMS. Ideal for office records. Personnel, stock, client's and account's records are more easily stored and updated. Features include: Comprehensive calculation • Full sorting facilities • Record selection on updates and reports • Wordstar interface for selective mailing. **£345/£25**

POINTS TO REMEMBER

- All software is Ex-Stock and available on standard 8" disks or 5" disks for Vector MZ, Superbrain, Dynabyte and NEC PC 8000.
- Prices shown as Software with manual/manual only.
- tml WORD-STAR is a trademark of Micropro.

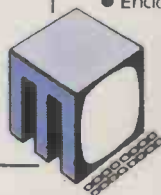

MICROSOFT INC.

BASIC 80 Interpreter **£155/£25**
BASIC 80 Compiler **£195/£25**
FORTRAN 80 **£215/£25**
COBOL 80 **£315/£25**

MICROPLAN

NEW MICROPLAN. A program designed to cope easily with advanced financial analysis. Microplan helps you to perform all the calculations you presently solve with pen, paper and calculator. Microplan will perform most types of calculations working on rows and columns. **£245/£20**

SUPERCALC

NEW SUPERCALC. Accountants, Planners, Engineers, and Business owners have found Supercalc invaluable for day to day "what-if?" and "what now?" questions. Answers for the time when the unexpected occurs. Simple to use advanced financial planning. **£190**

BCPL

NEW BCPL. BCPL CINTCODE is a full and extended implementation of the popular systems' programming language. BCPL CINTCODE gives a dramatic reduction in programme storage space, requiring about one third of a fully compiled Z80 code. **£250/£35**

DATA MANAGEMENT

SELECTOR III—C2. An easy to use information management system, requires C Basic II. **£185/£30**

SELECTOR IV. An advanced information management system requires C Basic II. **£275/£35**

S. BASIC VERSION 5.4. A high level language that combines the flexibility of Basic with the power of advanced structured techniques. A compiling language that is hard to match. **£175/£30**

METROTECH

MET/TWAM. An index sequential file access in C Basic II designed to increase the flexibility of C Basic. **£55/£20**

HOW TO ORDER

- State disk type and size • Add 15% VAT
- Include £2 per Software item for Postage and Packing
- Enclose cheque/PO's payable to METROTECH

CAXTON SOFTWARE

NEW OPTIMISER. A linear programming system for finding the best practical solution to resource allocation and planning problems. Easy to learn. Easy to use. Immediately available. Please ring for more details. **£295**

NEW CARDBOX. Described simply, Cardbox is an electronic card index system. Choose your own format for cards, and categorise the information to your own specification. Cardbox provides an immensely powerful method of handling large amounts of information. **£155**

COMMUNICATIONS

BISYNC-80/3780 and **BISYNC-80/3270** are full function IBM 2780, 3780 and 3270 emulators for micro computers. **BISYNC-80/3780** gives you a Remote Job Entry terminal for the price of a micro! **BISYNC-80/3270** combines the local processing power of a micro with a sophisticated screen capability. Make your dumb terminal smart! **MET/TTY** will connect your micro to a Timesharing service in simple teletype emulation.

BISYNC-80/3780 **£445/£20**
BISYNC-80/3270 **£445/£20**
MET/TTY **£145/£20**

FINANCIAL REPORTING

REPORT WRITER You input the values. Report Writer will perform your calculations and produce a report with your headings, totals and summaries. **£70/£10**

GLECTOR General Ledger option in Selector III, requires Selector III and C BASIC II. **£125/£30**

NEWLY RELEASED SOFTWARE

INFO STAR from MICROPRO **TBA**

Mail to **METROTECH MAIL ORDER**, WATERLOO ROAD, UXBRIDGE, MIDDLESEX UB8 2YW

CREDIT CARDS—Telephone orders welcome: Tel: UXBRIDGE (0895) 57048/9

TRADE ENQUIRIES WELCOMED

METROTECH

A MEMBER OF THE GRAND METROPOLITAN GROUP

ISBS-F

A FULLY INTEGRATED ACCOUNTING SYSTEM FOR THE SMALLER BUSINESS USER. DESIGNED FOR TWIN FLOPPY DISK SYSTEMS

A totally Integrated Small Business System designed for single user floppy disk based systems. Each package can be used stand alone or can be built into an integrated system depending on user requirements. All packages are fully supported and maintained, and are supplied with comprehensive reference manuals. ISBS-F is easy to install and ideal for the first-time small business user with no previous computer experience. Some of the main features of ISBS-F include:

STOCK CONTROL

- Optimum stockholding to keep costs to a minimum.
- Trends shown by monitoring stock movement and showing fast and slow moving lines.
- Accurate stock valuation at any time.
- Fast interrogation of any stock line for answering your customers enquiries.

ORDER ENTRY & INVOICING

- Accurate tracking of orders to make sure all your orders are fulfilled.
- Order acknowledgements to confirm customers orders quickly.
- Automatic reference to the back orders and drawdown of stock when invoicing, to prevent double entry.
- Flexible invoice layout to suit most companies needs.
- Sales analysis reports by product code and your own classification code to provide comprehensive sales monitoring.

NAME AND ADDRESS

- All your customers, suppliers and enquiries stored and maintained by one central system.

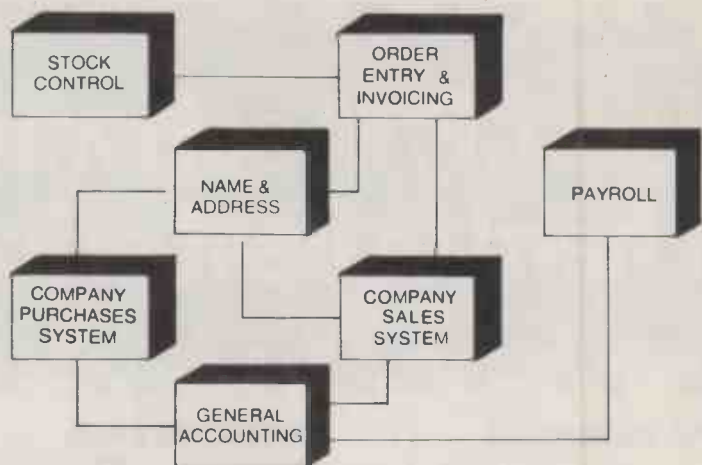

- Flexible report generation allowing you to design your own reports.
- Selective mailing labels to make light work of mailshots.

PAYROLL

- Flexible pay periods and methods to suit most professions and industries.
- Comprehensive in year and year end reports to save endless form filling
- Coin analysis for workers paid by cash helping to speed up pay packet preparation.
- Tax or national insurance updates as and when required to make budget changes easy.
- Overtime and special credits and deductions can be handled with ease.
- Security check prevents unauthorised use.

COMPANY PURCHASES

- Open Item or Balance Forward accounts depending on the nature of the goods being supplied.
- Credit control reports to ensure payments are made within your own target dates.
- Computerised cheque writing to save manual preparation.
- V.A.T. returns can be prepared speedily from V.A.T. analysis reports.

COMPANY SALES

- Invoices can be posted directly from the Order Entry and Invoicing System to save re-entry.
- Open Item or Balance Forward accounts to suit different customer types.
- Statements for your customers can be produced easily and at anytime.
- Comprehensive reports to assist credit control and maintain a healthy cash flow.
- V.A.T. returns can be prepared speedily from V.A.T. analysis reports.

GENERAL ACCOUNTING

- Flexible cost coding system which can be designed for your own company structure.
- Automatic generation of the Profit and Loss Account and Balance Sheet reflecting the financial position of your company at anytime.
- Budget controls over flexible periods to ensure expense accounts are not overrun.
- Data automatically retrieved from the Company Sales, Company Purchases and Payroll Systems which means that data is only entered once.

2020

WP2020 WORD PROCESSOR

WP2020 is an advanced word processing system which runs on selected 8080 based microcomputers. In addition to all the standard features of a word processing system such as margins, tabs, pagination, global search and replace, proportional spacing etc., the system also offers the following:

- Special set of coloured function keytops supplied as standard.
- Menu driven system designed for typists and secretaries — there are no complicated control codes to remember.
- Advanced facilities such as a spelling checker, merge documents module, communications, and integration with ISBS-F supplied as standard.
- Supports background printing whilst working on other documents.

CM 2020 CONFIGURABLE MANAGER

CM2020 is a powerful information retrieval system which the user can configure to suit individual needs. It has been designed for the user without any special computer background. The user has total control over the application environments by defining the basic filing system, input screen formats and output reports. CM2020 is easy to learn and use, an application which might normally require weeks or months without CM2020 can be set up and running in a matter of hours or days. For the technically minded there is also a FORTRAN and RATFOR compiler available so that other programs can be developed to interface with a CM2020 data base. Some of the typical applications for CM2020 would be:

- PERSONNEL MANAGEMENT
- PARTS FILES
- MAILING LISTS
- PROJECT MANAGEMENT
- QUESTIONNAIRE ANALYSIS
- SALES ENQUIRIES AND LEADS

FP2020 FINANCIAL PLANNER

The FP2020 provides a new approach to management planning, whether it is financial, budget, job cost, cash flow, product pricing, engineering etc., FP2020 will accurately forecast the effect of proposed actions. Data is entered interactively having defined the size of the model or 'spreadsheet'. The user can then use the standard functions to calculate cell values or use the special functions (mathematical or statistical) to perform more complex arithmetic. Models and definitions are stored on disk and can be retrieved at a later stage. The user can define his own output reports as required and graphic output can also be obtained.

GRAFFCOM SYSTEMS GROUP

Application software for 8 and 16 bit micros

GRAFFCOM SYSTEMS LTD. 102 PORTLAND ROAD, HOLLAND PARK, LONDON W11 4LX TEL: 01-727 5561

ISBS-W

AN INTEGRATED OFFICE ACCOUNTING AND ADMINISTRATION SYSTEM TO MEET MULTIWORKSTATION REQUIREMENTS. DESIGNED FOR HARD DISK BASED SYSTEMS

A professional Integrated Business System designed for microcomputers which use Hard disks or Winchester disks. ISBS-W is ideal for the small to medium business where data storage and processing speed exceeds the capabilities of floppy disk based systems. Users of ISBS-F can upgrade to ISBS-W as the business expands using GRAFFCOM's System Migration Plan — SMP. The user can choose from any combination of modules and add others at a later stage if required. All modules are fully maintained and supported and comprehensive documentation is supplied for each application. Some of the main ISBS-W features include:

BUSINESS CONTROLLER

The Business Control Module acts as a task manager and supervisor for the ISBS-W system. It takes care of system definition parameters such as the number of hard disks, numbers of workstations and printers. Operators will feel at ease with the Business Control menu which will prompt for application tasks such as word processing, accounting modules or, order processing etc. The controller will also take care of file protection and authority of access via a password system. It also incorporates a data archive and retrieval option allowing the user to make back-up copies of the data system as often as required.

ACCOUNTING MODULES

All standard accounting tasks are catered for and include sales, purchases and nominal ledgers. The payroll module is fully supported in terms of legislative changes. Standard management reports include budgetary control, Profit and Loss Statements and Balance Sheets.

STOCK CONTROL AND ORDER PROCESSING

Orders can be entered as received and the system provides a comprehensive tracking mechanism until all goods have been shipped. Invoice production provides automatic release of stock and drawdown of order items.

WORD PROCESSING

An advanced automated office computer system would not be complete without an integrated word processing module. This module provides all the standard word processing facilities and has in addition a merge document feature for personalised letters and a built-in spelling checker. The word processing terminal will have custom keytops which makes light work of all word processing tasks for the operator.

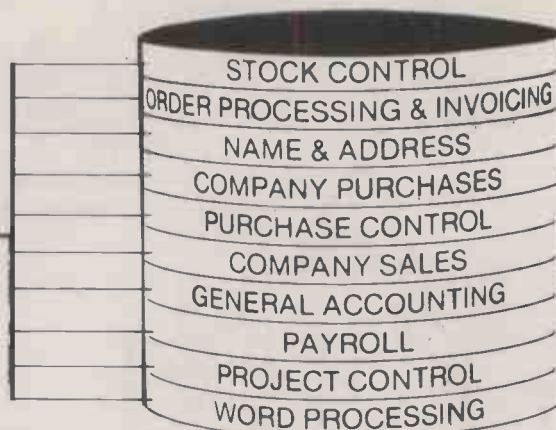

*Check for release date

SPECIAL INTEREST

LEASE, RENTAL & HIRE PURCHASE SYSTEM

The LR & HP System is designed to control agreements and contracts that are payable at regular intervals by fixed amounts. The system, is designed to interface with the ISBS-F Company Sales System and the Name & Address System.

TIME RECORDING SYSTEM

The TRS is designed for those organisations which offer a 'service' rather than a 'product'. Typical users would be Accountants, Solicitors, Management Consultants, Architects, Quantity Surveyors etc. The system controls manhour expenditure and expenses by job or account numbers.

MIPS — MANAGEMENT INFORMATION PLOTTING SYSTEM

MIPS is a standard package which interfaces with ISBS-F, ISBS-W and the 2020 series to produce a range of management graphs and charts. It is designed to support industry standard plotters from the Hewlett Packard and Tektronix range. (Check with us direct for a complete list of supported plotters).

Graphics output includes:

- ISBS-F — budget comparisons, sales analysis, cash flow etc.
- ISBS-W — budgetary control, sales and product analysis, cash flow etc.
- FP2020 — various, depending on characteristics of Model.

LINKS PROCESSOR

This is an interprocessor link program designed to attach two processors back to back for CP/M file transfer. One processor is defined as the master and the second as a slave.

INTEL 8048 ASSEMBLER

The 8048 assembler produces 8048/35 romable machine code. Source input is created using the CP/M editor ED. Output is to disk in Hex format or printed listing.

Software is suitable for use with the following systems:

AI ABC24,26
ARCHIVES
CIFER
COLUMBIA DATA PRODUCTS
CROMEMCO
COMART COMMUNICATOR
DEC VT18X
DURANGO
DYNABYTE

HEATH
HEWLETT PACKARD 125
IBM DISPLAYWRITER
IBM PERSONAL COMPUTER
IMS
MILLBANK
NEC PC8000
NORTHSTAR
PET (with softbox)

RAIR
SHARP
SIRIUS 1
SUPERBRAIN
TANDY MODEL II
TEI
TRANSAM
TVI
XEROX 820
plus many more

For further details on system requirements check with your dealer or call us direct.

For more information on GRAFFCOM products please complete the form.

ISBS-F <input type="checkbox"/>	ISBS-W <input type="checkbox"/>	2020 <input type="checkbox"/>	SPECIAL <input type="checkbox"/>
NAME.....		COMPANY.....	
ADDRESS.....			
Please tick as required and return to 102 Portland Road, London W11 4LX			



Gemini MultiBoard THE

STOP & PICK UP ANY MULTIBOARDS ON YOUR WAY

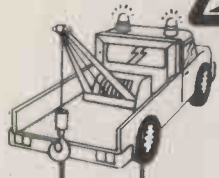

CHEAPSKATE ROUTE

ESOTERIC ROUTE

GM 807

3 amp PSU for the smaller system

GM 810

5 amp PSU with an 8-slot Motherboard

GM 811 CPU

Utilising the powerful 4MHz Z80A Microprocessor the GM811 CPU card can be used as either a stand alone controller or as the heart of a complex microcomputer system. Four 'Byte-wide' sockets allow great flexibility in the type and size of memory devices chosen. Input and output facilities include both programmable serial and parallel interfaces - RS232, 1200 baud CUTS cassette interface, Z80A PIO, and an eight bit input port. In an expanded system the unique on-board RP/M monitor allows the creation of cassette or Eprom based programs or files which are upwards compatible with a disk based CP/M system.

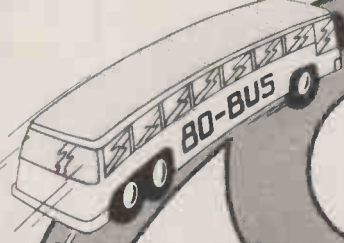

nascom OWNERS START HERE

GM 813 CPU/RAM

Similar to the popular GM811 CPU card, the new GM813 CPU/RAM card has 64K of dynamic RAM replacing the 'byte-wide' sockets. An extended addressing mode facilitates future memory expansion up to 2 megabytes! The RP/M 2 monitor retains full RP/M - CP/M compatibility.

With a 59 key full QWERTY layout, this ASCII encoded keyboard includes cursor control keys, caps. lock, two key rollover and auto-repeat.

GM 821 KEYBOARD

80 BUS STATION

ROUTE

The Gemini MultiBoard concept is the logical route to virtually any microcomputer system you care to name. Whether you require a business system, an educational system, a process control system or any other system, there is a combination of MultiBoards to fulfil that function.

This concept ensures maximum flexibility and minimal obsolescence. Maintenance and expansion is greatly enhanced by the modular board design. MultiBoard is based on the 80-BUS structure, which is finding increasing acceptance among other British manufacturers; thus broadening the product base.

FARES

Hardware (Built & tested)

GM802	64K RAM card	£140
GM803	EPROM/ROM card	£65
GM807	3A PSU	£40
GM808K*	EPROM programmer	£29.50
GM809	FDC card	£125
GM810K	5A PSU/8 slot motherboard	£69.50
GM811	Z80 CPU card	£125
GM812	Z80 IVC card (*KII)	£140

Software

GM512	CP/M 2.2 for MultiBoard	£90
GM517	Gem-Zap edit/asm tape	£45
GM518	Gem-Zap edit/asm disk	£45
GM519	Gem Pen editor/ text formatter tape	£45
GM520	Gem Pen editor/ text formatter EPROM	£45
GM521	Gem Pen editor/ text formatter disk	£45

GM813	Z80 CPU/64K RAM card	£225
EV814	IEEE 488 card	£140
GM815-1	Single drive disk unit with PSU (350K)	£325
GM815-2	Double drive disk unit with PSU (700K)	£550
GM816	Multi I/O board	£125
AM819	Speech board	£85
AM820	Light Pen	£35
GM821	ASCII keyboard	£57.50

GM524	Gem Dis disassembler/ debugger tape	£30
GM525	Gem Dis disassembler/ debugger disk	£30
GM526	Comal-80 tape	£100
GM527	Comal-80 disk	£100
GM528	APL disk	£200

LOGICAL ROUTE

GM 812
-IVC

The GM812 Intelligent Video Controller card features an on board Z80A processor to provide independence of the host processor and the ability to redefine the functions and parameters of the display.

Normally used in an 80 x 25 mode the card contains a programmable character generator allowing three additional modes of operation - inverse characters, 160 x 75 block graphics, or user defined characters.

A keyboard socket allows buffered character input, and a light pen socket is provided for specialist applications. Being I/O mapped the card does not occupy any system memory space.

GM 809
FDC

GM 809 FDC

The GM809 floppy disk controller card can support up to four disk drives in either single or double density modes. The card uses the Western Digital 1797 controller and has variable write precompensation and phase locked loop data recovery circuitry.

GM 815
DRIVE UNIT

GM 815 Drive unit

The GM815 floppy disk housing contains one or two 5 1/4" double density, double sided Pettec FD 250 drives. This gives a storage capacity of 350K per drive. Power for the drives is provided by an integral supply unit.

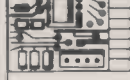

AUTO-EXCHANGE
All your RP/M software automatically transferred to CP/M



FILL-UP WITH SOFTWARE



A CP/M 2.2 package is available with the GM 809 card and Pettec drives. On-screen editing auto single/double density selection and parallel or serial printers are supported. Running under CP/M is a wide range of utilities, application software and languages.

The GM802 RAM board provides a full 64K of dynamic memory. The 80 BUS RAMDIS signal is fully supported so that any EPROM in the system is given priority over the RAM, preventing any possibility of bus contention. Page Mode is also supported by the card which, with the appropriate software, allows up to four memory boards to be used in a system.

GM 802
RAM

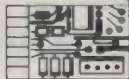

RP/M software is available on tape and includes Editor/Assembler; Text Editor/Formatter; Disassembler/Debugger; Pascal and Comal-80. These packages can also be run under CP/M.

The GM803 Eprom Board will accept up to 16 2708 or 2716 Eprom devices. This allows the addition of up to 32K of firmware to the system. The board supports the Page Mode system and consequently need not occupy any memory space when not in use.

GM 803
EPROM BOARD

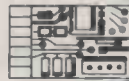

A number of manufacturers are busy working on additional 80-BUS boards which will progressively increase the potential of your MultiBoard system.

ONE WAY

80 BUS compatible prototyping boards are available from both Vero and Winchester Technology. These allow the user to easily add a card of their own design to the system.

PROTO-TYPING BOARDS

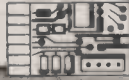

GM 816
I/O BOARD



The Gemini I/O board provides a unique solution for interfacing to "the real world". The board contains 3 PIO's, a CTC and a real time clock with battery back up. "Daughter" boards may also be added and these include A-D, D-A, opto-coupling and serial interface boards.

GM 808
EPROM PROGRAMMER



The GM808 Eprom programmer connects to the PIO on the CPU card and allows the user to program 2708 or 2716 type Eproms.

AM 819
SPEECH BOARD



The Aron Microelectronics speech board utilises the National Semiconductor Digitaler chip set. This gives a vocabulary of over 140 words and sub sounds. Output is from an on-board speaker.

AM 820
LIGHT PEN



This low cost light pen can be used with the GM812 IVC for many applications, including answer selection, editing, menu selection and movement of displayed data blocks.

EV 814
IEEE 488



The EVC IEEE 488 Controller card has been designed to fully implement all IEEE 488 interface functions. This card gives the user a very versatile method of controlling any equipment fitted with a standard IEEE 488 or GPIB interface at minimal cost.

GEMINI MULTIBOARDS - BUY THEM AT YOUR LOCAL MICROVALUE DEALER

All the products on these two pages are available while stocks last from the MicroValue dealers listed on right (Mail order enquiries should telephone for delivery dates and post and packing costs.) Access and Barclaycard welcome.



INTERFACE COMPONENTS LTD.
Oakfield Corner, Sycamore Road,
Amersham, Bucks.
Tel: (02403) 22307. Tlx: 837788.

COMPUTER INTERFACING & EQUIPMENT LTD.
The MICRO-SPARES Shop,
19 Roseburn Terrace,
Edinburgh EH12 5NG
Tel: (031) 337 5611

E. V. COMPUTING
700 Bumage Lane, Burnage,
Manchester M19 1NA.
Tel: (061) 431 4866.

ELECTROVALUE LTD.
28 St Judes, Englefield Green,
Egham, Surrey TW20 0HB.
Tel: (0784) 33603. Tlx: 264475.

SKYTRONICS,
2 North Road, The Park,
Nottingham.
Tel: (0602) 45053/45215

TARGET ELECTRONICS
16 Cherry Lane, Bristol BS1 3NG.
Tel: (0272) 421196.

BITS & PC'S
4 Westgate, Wetherby,
W. Yorks.
Tel: (0937) 63774.

HENRY'S RADIO
404 Edgware Road, London W2.
Tel: (01) 402 6822.
Tlx: 262284 (quote ref: 1400).

LEEDS COMPUTER CENTRE,
62 The Balcony,
Merrion Centre, Leeds.
Tel: (0532) 458877

● Circle No. 110

Practical Computing



Olivetti DM 5100 – Price: £900.00



Olivetti DM80/180cps – Price: £1995.00



Olivetti DY211 – Price: Only £900.00!



Oume Sprint 5 Range – Prices from: £1700.00



Olivetti DY311 – Price: £1050.00



Olivetti DY811 – Price: £1995.00

Practical Computing is not only the name of a magazine. It is also a philosophy about which we feel strongly at Millbank Computers.

Practical computing solutions which meet the needs of the user is the basis on which we have built up our range of hardware, software and services.

We start with the **Millbank System 10** – the 'heavy duty' micro computer available exclusively from us and our appointed dealers. With 700K, 1.6 MB and hard disc options, the **Millbank System 10** is arguably the most reliable micro available in the UK – supported,

naturally, by twelve months full warranty.

Our range of printers covers dot matrix and letter quality printing at virtually every acceptable speed, specification and price point.

The CP/M disc operating system opens up a vast range of readily available software – including 'Financial Director' – a British Accounting suite of stunning quality and E.A.M.I.S. a new Management System for Estate Agents.

Service and support is an integral part of our practical computing philosophy.

Call us today.

**MILLBANK
COMPUTERS**

Millbank Computers Limited, Millbank House, Amyand Park Road, Twickenham TW1 3HN. Tel: 01-891 4691.

and where to find it.

BIRMINGHAM

Based in the heart of the professional area of Birmingham, Midland Micro Ltd provides a comprehensive computer service to users in the Midlands.

We supply everything from a single diskette to an advanced network or Mini-computer system using standard software and tailor-made packages.

Services provided by our experienced staff include consultancy, training, maintenance, and full after-sales service.

Contact: Ernest Willcox or Ian Willcox
Midland Micro Ltd
George House, George Road
EDGBASTON, Birmingham B15 1PG
Telephone: (021) 455 7431

CALNE, Wiltshire

Suppliers of accounting and related business software in particular, the Financial Director package incorporating bought and sales ledgers, cash book, nominal ledger, budgets and monthly management accounts.

Other software, eg. order entry, invoicing and stock control, tailored to individual user requirements.

Microshade provides a total sales and support service for the System 10.

Contact: Bryon Horton
Microshade (Business Computers) Ltd
Westhill House, 4 Market Hill
CALNE, Wiltshire
Telephone: (0249) 814879

CAMBRIDGE

The Avery Computer Company showroom caters specifically for the needs of local small businesses. A wide range of systems cover applications from financial modelling, forecasting, payroll etc. to large multi-user systems which can carry out all the functions of the electronic office.

We supply standard and customised software, special computer-aided learning courses and, above all, maintain close client liaison before and after installation.

Contact: Michael Avery or David Spry
The Avery Computer Company
13 The Mall, Bar Hill
CAMBRIDGE CB3 8DZ
Telephone: (0954) 80991

CHELTENHAM

'We won't blind you with science' is the basis of this locally owned company's services to businesses, institutions and individuals.

Partners have wide-ranging business and computer experience and have built up an impressive range of books, manuals, personal computers, business computers, standard software and consumables.

Contact: David Lewis,
Robin Phelps or Don Price
The Computer Shack
14 Pittville Street
CHELTENHAM, Gloucestershire
Telephone: (0242) 584343

EXETER

Teffont Business Systems have specialised in 'word communication' equipment throughout south-west England for the past three years.

The computer division markets Micro and Mini computers. We put strong emphasis on well-proven business software, word-processing, telecommunication, and professional service/training by experienced engineering and training staff.

We also supply 'Europe's No. 1' range of facsimile machines and are Prestel dealers.

Contact: Stephen Taylor
Teffont Business Systems Ltd
48-49 High Street, EXETER EX4 3DJ
Telephone: (0392) 30438/9

EPSOM, Surrey

The primary business of Bryan Wright Ltd is the production of programmes to meet specialised and individual needs, exclusively for the Millbank System 10 Micro-computer range.

Consultancy and advice to potential Micro-computer users.

Specifications, analysis and programming. A personal after-sales service for users' operational problems, for changing requirements in programming, and system upgrading.

Address labels and mailing-list service, with statistical analysis by areas or other criteria including delivery within a reasonable distance from Epsom.

Contact: Bryan Wright or Denis Wright
Bryan Wright Ltd
1st Floor, 57 South Street
EPSOM, Surrey KT18 7PX
Telephone: (78) 22653

MANCHESTER

Calderbrook Technical Services (CTS) moved successfully into the Micro computer business in the mid 1970s and now offer a wide range of products from personal to business systems, plus a vast software library.

CTS apply a very high level of technical and engineering skills to system design, installation, training and after sales service & maintenance.

Contact: Peter Fawthrop
Calderbrook Technical Services
31-33 Church Street
LITTLEBOROUGH, Lancs OL15 8DA
Telephone: 0706 74342/79332

SWANSEA

Croeso Computer Services is a well established Micro computer systems house specialising in turnkey systems for financial companies, bakeries, licenced trade stock-taking and petrol stations.

We design specialist software systems for individual requirements in business, industry and the professions. A wide range of computer equipment is available.

Contact: Simon Shellard or
Michael Breach
Croeso Computer Services
516 Mumbles Road, MUMBLES
Swansea, West Glamorgan
Telephone: (0792) 61555/6

LONDON (C)

Forte Data Systems offer a complete business computer service from feasibility study to implementation. We provide a wide range of evaluated business packages based on cost-effective solutions to user requirements, using customised software if necessary.

First-time users find our free consultation service an ideal starting point, existing users may be more interested in our main-frame and distributed data processing software development service.

Contact: Mr V. Sippy
Forte Data Systems
27 Rathbone Street, LONDON W1
Telephone: (01) 637-0164

LONDON (N)

B D Computer Systems brings 'mainframe' levels of skills and professionalism to the Micro market. Our experience in selling and installing large computers now provides full operational systems solutions in the Micro market.

Our customers range from a small professional user to a large Government department.

We are ideally placed to serve all London and Home Counties organisations north of the Thames.

Contact: Hugh Benham,
Susan Weitzkorn or Peter Hines
B D Computer Systems
2 Old Brewery Mews
Hampstead High Street
LONDON NW3 1PZ
Telephone: (01) 435-4442

LONDON (S)

Micro Automation Computing Ltd was formed in 1979 with over fifty man years of computer experience to provide and support systems and software based on Micro and Mini technology.

Special emphasis is placed on real time systems for commercial, industrial and engineering applications. Services available include the supply of complete computer systems, tailored turnkey systems and packages, data base applications, specialised drivers for word-processing and colour graphics, and systems software for Micros.

Contact: David Shorter
Micro Automation Computing Ltd
207 Putney Bridge Road
LONDON SW15 2NY
Telephone: (01) 874 2535

This is not a comprehensive list of Millbank dealers so if your area is not covered by any of the dealers listed here call us direct.

Millbank Computers Limited
Millbank House Amyand Park Road
TWICKENHAM TW1 3HN
Telephone: 01-891 4691

G. W. COMPUTERS LTD.



SuperBrain users get exceptional performance for just a fraction of what they'd expect to pay. Standard SuperBrain features include: two double density mini-floppies with 350kbytes of disk storage, 32k of RAM memory (expandable to 64k) to handle even the most sophisticated programs, a CP/M® Disk Operating System with a high powered text editor, assembler, debugger and a disk formatter. And, with SuperBrain's S-100 bus adaptor, you can add all the programming power you will ever need... almost any type of S-100 compatible bus accessory.

SuperBrain's CP/M operating system boasts an overwhelming amount of available software in BASIC, FORTRAN, COBOL, and APL. Whatever your application... General Ledger, Accounts Receivable, Payroll, Inventory of Word Processing, SuperBrain is tops in its class. And the SuperBrain QD boasts the same powerful performance but also features a double-sided drive system to render more than 700k bytes of disk storage and a full 64k of RAM. All standard!

Whatever model you choose, you'll appreciate the careful attention given to every engineering detail. A full ASCII keyboard with numeric pad and user-programmable function keys. A non-glare, specially focused 12-inch CRT for sharp images everywhere on the screen. Twin Z-80 microprocessors to ensure efficient data transfer to auxiliary peripheral devices. Dual universal RS-232 communications ports for serial data transmission. And, a single board design to make servicing a snap!



Integrated Desk Top Computer with 12 inch Bit-Mapped Graphics or Character Display. 64Kb RAM, 4 MHz Z80A, ® Two Quad Capacity Floppy Disk Drives, Selectric Style 87 Key Keyboard, Business Graphics Software.

The North Star ADVANTAGE™ is an interactive integrated graphics computer supplying the single user with a balanced set of Business-Data, Word, or Scientific-Data processing capabilities along with both character and graphics output. ADVANTAGE is fully supported by North Star's wide range of System and Application Software.

The ADVANTAGE contains a 4MHz Z80A® CPU with 64Kb of 200 nsec Dynamic RAM (with parity) for program storage, a separate 20Kb 200 nsec RAM to drive the bit-mapped display, a 2Kb bootstrap PROM and an auxiliary Intel 8035 microprocessor to control the keyboard and floppy disks. The display can be operated as a 1920 (24 lines by 80 characters) character display or as a bit-mapped display (240x640 pixels), where each pixel is controlled by one bit in the 20Kb display RAM. The two integrated 5-1/4-inch floppy disks are double-sided, double-density providing storage of 3600Kb per drive for a total of 720Kb. The n-key rollover Selectric style keyboard contains 49 standard typewriter keys, 9 symbol or control keys, a 14 key numeric/cursor control pad and 15 user programmable function keys.

G. W. COMPUTERS LTD. 01-636 8210, 01-631 4818, TELEX 892031 TWCG

★★★ THE NEW DBMS III (DATABASE) ★★★

The DBMS III is an enhanced version of DBMS II with additional facilities that make it (we believe) unsurpassed in overall capability world-wide. For the first time, it is possible to pre-determine the entire route of this program from its own built in self-drivers. The notion of getting information 'at the touch of a button' is rarely even achieved by other programs whereas in DBMS III it is surpassed.

It will take you time to master the technique of setting up files that are particular to your activities, but when this is accomplished you will be able to 'clone-copy' the program DBMS III in such a manner that each copy may become dedicated functionaries to specific tasks for as long as you wish.

The end result will be a number of disks whose sole purpose in life will be to perform specific tasks WITHOUT ever touching a single key. Say your company is a garage; you want stock-level re-order reports; your stock file contains 20,000 records of parts where among other information you have 'MINIMUMS', 'MAXIMUMS', 'PRESENT STOCKS' and 'COST'. You design a report so that all records where stock is below minimum, the stock is subtracted from the maximum to produce a re-order report and the cost of such an order. Having set up the files and print report forms, you now enable the DBMS III SELF-DRIVERS, to pre-ignite.

Every time you want a stock-re-order-cost-report you simply follow this procedure, with the computer and printer switched on: Insert the 'STOCK-FILE DISK' and the 'DBMS III FUNCTIONARY DISK', close the drive doors, and walk away. On your return you will find your report ready for action.

Imagine being able to do that for most of the tasks you have about you? Hospital serum analysis reports, Production control process reports, Ledger analysis reports, Client address reports, Housing management reports. In fact most anything whose nature concerns information.

Additional features include field protection, classified fields, passwords to files, increased number of fields, screen form designing, automatic 10 second screen refresh for network systems, additional search/maths functions.

A leader in database and information processing at this time. The DBMS III (£575.00 exc vat and exc mbasic 80). Only from G. W. Computers Ltd.

NOTE: the above menu options are subject to change without notice or obligation, the bus program 8.00 includes DBMS II if purchased at 675.00 and thus a number of program menus are available.

24 HOUR ANSWERPHONE-LEAVE ADDRESS FOR STANDARD INFORMATION DATA PACK

IMPORTANT!!! No hardware is any value without the software, and our software is unequalled. Buy a complete system and get most of the software free.

SUPERBRAIN * CORVUS DSK		NORTH STAR * TELEVIDEO		NEC/UKI * PRINTER	
SUPERBRAIN 320K	1695.00	NORTH STAR 700K	2495.00	OKI MICRO-82A	575.00
SUPERBRAIN 700K	2195.00	NORTH STAR 5.3M	3495.00	OKI MICRO-83	795.00
SUPERBRAIN 1500K	2595.00	TELEVIDEO 7.6M	4595.00	OKI MICRO-83A	850.00
COMPUSTAR 10 OK	1695.00	TELEVIDEO T'MNL	1195.00	EPSON MX80FT	475.00
COMPUSTAR 20 320K	2495.00	TELEVIDEO 700K	2395.00	EPSON MX100	675.00
COMPUSTAR 30 700K	2695.00	VTR MIRROR DUMP	695.00	TEXAS 810	1395.00
COMPUSTAR 40 1.5M	2995.00	7 STATION M'PLEX	695.00	SCRIPTA KSR	975.00
COMPUSTAR 10M DSK	2950.00	BUS ACCOUNTS 8.0	575.00	NEC 3350	1395.00
CORVUS 5.6M H'DSK	1950.00	DBMS II	575.00	NEC 5510	1795.00
CORVUS 10M H'DSK	2950.00	NEC 8001/12/31	1850.00	NEC 5525	2095.00
CORVUS 20M H'DSK	3950.00	QUME S/S FEEDER	750.00	QUME 9/45	1695.00
MBASIC 80	150.00	FORTRAN-80	200.00	COBOL-80	320.00
CIS COBOL	420.00	PASCAL (VARIOUS)	175.00	WORD-STAR	250.00
MAIL MERGE	55.00	SUPER SORT	120.00	C8ASIC	75.00
DATASTAR	190.00	BASCOMPILER	190.00	MAGIC WAND	190.00
DBMS & BUS 8.00	675.00	MAGIC CALC (CPM)	175.00	T/MAKER	150.00
DBMS (EXTENDED)	575.00	BUS VER 8.00	575.00	DBMS & BUS	675.00
MSORT & DSORT	75.00	LETTERIGHT	100.00	UTILITIES	150.00

Formats: (for Basic, DBMS II, N'STAR & SUPERBRAIN 5")... (for super-calc 8"); Zenith; Xerox; Apple; Vector. (for Magic Wand/Calc = N'Star & Superbrain)

Any of our computer terminals automatically include ***** FREE *****

***** MAGIC WAND WORD PROCESSING SOFTWARE *****

***** TESTING AND DELIVERY *****

***** 90 DAY WARRANTY *****

For 1 year's warranty add 10% hardware cost, maintenance prices please call

Mail address G. W. Computers Ltd. 55 Bedford Court Mans. Bedford Avenue, W.C.1

London Telex 892031 TWC G

Boston Office Telex 94-0890

Contact 01-636. 8210 or 01.631. 4818 and if unavailable then leave a call-back message (clearly stating your telephone number and name) on the 24 hour answer-phone or simply leave your address and we'll mail you a standard information pack. We regret we do not operate a reader's reply card service. Terms: C.W.O. or C.O.D. (prices exclude VAT) Software sales are 'mail order only'. No dealers.

CALL ONLY BY PRIOR APPOINTMENT AT 55 BEDFORD COURT MANSIONS, BEDFORD AVENUE, LONDON W.C.1

● Circle No. 112

UltraBrain

Introducing
Intertec's NEW
SuperBrain II
from
Helistar Systems



Intertec's New Features on SuperBrain II

- ★ Real Time Clock and Calendar with battery back-up.
- ★ Second user-defined character set — useful for foreign languages, block graphics and more.
- ★ Character display attributes — inverse video, half-intensity, underline and blink.
- ★ 7 x 10 character matrix gives true lower-case descenders.
- ★ Faster disk-drive stepping speed.
- ★ Microsoft BASIC included with every SuperBrain II.

Special UltraBrain Options from Helistar Systems

- ★ Automatic motor-off for longer diskette and drive life.
- ★ Green screen.
- ★ Five day burn-in for greater reliability.
- ★ CDBIOS Extended Operating System with eight improved features for the operator and programmer.
- ★ FASTCOPY formats and copies a disk in one operation — will back-up a QD disk in less than two minutes.
- ★ Teletype emulation.

Full Range of CP/M Software Available

- ★ Word Processing using memory-mapped WordStar.
- ★ Financial Planning with FASTPLAN.
- ★ Numeric manipulation using SuperCalc.
- ★ Accounting, Stock Control and more with the TABS business system.
- ★ Rapid applications development with dBASE II data base.
- ★ Program development with BASIC, COBOL, FORTRAN, PASCAL.

Software programmable keys



Example keys for WORDSTAR

... MORE SUPERBRAIN FOR LESS MONEY

High-Resolution Graphics Options

- ★ Micronex PIXELPLOTTER Graphics Hardware.
High Resolution 1024×1024 pixels from £675.
Medium Resolution 512×256 pixels from £435.
Also available as a retro-fit for SuperBrain I.
- ★ Micronex Graphics Software.
Graph Plotter, Surface Plotter, 3-D Drawing,
Tektronix Emulation, Graphics Primitives.
- ★ Fluid Dynamic Engineering Software.
Flexure of Beams, Selection of Roller Bearings,
Design of Centrifugal Pumps, Critical Shaft Speed,
Dimensioning of Springs, 3-D Drawing.
- ★ Micronex VU-DISK Software.
Turns the memory on the graphics board into a
pseudo disk — appears to the user as a very fast
disk drive ideal for holding random access files.

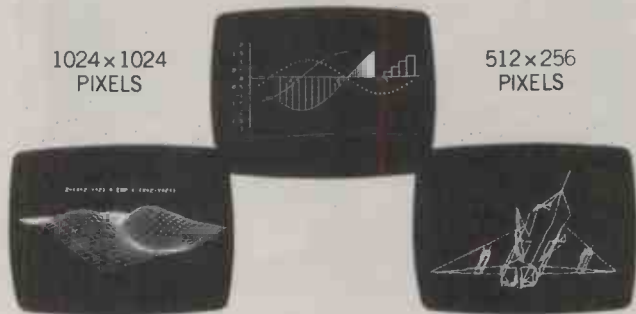

Helistar's Special SuperBrain II Prices

SuperBrain II	DD	350K	£1695
SuperBrain II	QD	750K	£1980
SuperBrain II	SD	1.5Mb	£2330

including CP/M and Microsoft BASIC

Winchester Hard Disk Options from £1490

Leasing and rental terms available

The above are Full Service prices for the standard SuperBrain II —
Cash and Carry discounts quoted on request. Please ask for price
lists on UltraBrain options, Graphics, Software, Printers and
Maintenance. VAT to be added to all prices.

Fill in the coupon for more information and send to:

HELISTAR SYSTEMS

150 Weston Road
Aston Clinton
Aylesbury
Bucks HP22 5EP
Telephone: 0296 630364
Telex: 837520 ADTRAV G
ATTN HELISTAR

Technical Support

- ★ Advice and assistance available from our
programmers and engineers.
- ★ On-site and workshop maintenance on a contract or
ad-hoc basis.

UltraBrain

More SuperBrain from
Helistar Systems

Please send me more information on SuperBrain
hardware and software.

Name _____

Position _____

Company _____

Address _____

Tel no. _____

YOUR DATA LIFELINE



The **DATALIFE** Series of magnetic media from Verbatim, incorporates many advanced data shielding benefits. These ensure a longer, more trouble-free recording, storage and retrieval life – quite simply Datalife is the best range of media available today.

And now BFI, the UK's major distributor of Verbatim products, has introduced a new service – called the Datalife Line. Call us on the Datalife Line and we can offer you fast deliveries, competitive prices on Verbatim products, excellent back-up and technical advice on flexible disks, mini diskettes, data cartridges, digital cassettes, alignment disks, XE disks and Datalife head cleaning kits.

**CALL THE Datalife™
LINE NOW:**

01-941-4066

Scottish Distributor:
Computer Supplies Co.,
8/18 Union Street, Bo'ness,
West Lothian, Scotland.
Tel: 050-682-3393

BFI Electronics Ltd.,
516 Walton Road,
West Molesey,
Surrey. KT8 0QF
Tel: 01-941 4066
Telex: 261395

Buy our £475* Daisy Wheel Printer for your computer and you have an Electronic Typewriter absolutely FREE



The T/Printer 35 is the lightest weight and lowest cost daisy wheel printer you can buy for your computer. So it will fit within your budget and you can carry it wherever you take your micro. Yet it is tough enough to give years of reliable service. Interchangeable typefaces (standard Olivetti 100 character daisy wheels), variable pitch, multiple copies – all the features you would expect of more expensive word processing printers.

Yet the T/Printer 35 costs only £475 with parallel interface. Operating speed under computer control is approximately 120 words per minute of letter perfect output. What typist can equal that?

Then when you're finished using it as a computer printer, the T/Printer 35 is ready to go right on working as an electronic typewriter.

That's the dual-purpose T/Printer 35 – the versatile computer printer that fits your budget.

Orders are shipped within the UK carriage-free. To order or for more information about the T/Printer 35:

**The T/Printer 35 costs £475 with Centronics compatible parallel interface. With RS-232C interface it costs £535. Prices listed are exclusive of VAT.*

Datarite Terminals Ltd
Caldare House
144-146 High Road
Chadwell Heath, Essex RM6 6NT
Tel: 01-590 1155

● Circle No. 114

● Circle No. 115



THE Northern Computer Fair
Personal computers
Home computing
Small business systems

**MANCHESTER,
NOV 25-27**

Bringing it all back home...

... to Manchester, birthplace of computing in Britain. To Belle Vue from November 25th to 27th — the obvious place for the Northern Computer Fair.

Following the incredible success of our London show 'the biggest-ever personal computer exhibition' where over 38,000 people visited us in 3 days, we're going to repeat the performance in Manchester.

Whatever your specialised line of business — personal computers; home computing; small business systems; associated software — this is the exhibition designed for you.

It's the ideal showcase for companies who need to demonstrate to a fast expanding and increasingly well informed audience all aspects of personal computing.

... you cannot afford to ignore it.

For further details about exhibiting at the Northern Computer Fair, contact the Advertisement Manager, Practical Computing, Room L310, Quadrant House, The Quadrant, Sutton, Surrey SM2 5AS. Telephone: 01-661 3500 Ext 3021

Name: _____

Position in Company: _____

Company: _____

Address: _____

Telephone: _____

C/WP's GREAT SUMMER PRINT-OUT

C/WP not only sell APPLE computers at prices so low they turn others green. We sell printers at ridiculous prices, too.

If your printer is off-colour buy a new one from C/WP, the micro-computer experts. Whatever make your computer you can benefit from our summer madness.

Or why not a little madness of your own and treat yourself to a brand new APPLE computer to run your printer. APPLE prices have never been lower. And ours are the lowest anywhere.

Whether you want a printer, an APPLE, or any of the hundreds of add-ons and peripherals we stock, you'll find it hard to find a keener price or more knowledgeable support.

Write or phone or just pop in for our full hardware and software list.

If you're hungry for a printer at these incredible prices, contact C/WP Computers on 01-630 7444.

C/WP

C/WP Computers
108 Rochester Row, London SW1P 1JP
Telephone: 01-630 7444

C/WP PRINTER OFFER

<u>MATRIX PRINTERS</u>	EX-VAT PRICES	
	TYPICAL PRICE £	C/WP PRICE £
Seikosha GP100A 30cps, tractor	215	149
Microline 80, 80cps friction and tractor	235	199
Microline 82A, 120cps friction and tractor	350	299
Microline 83A, 120cps friction and tractor, 15.5 inch paper	575	479
Centronics 739, 100cps friction and tractor	529	349
Epson Type 3 (80 and 100)		PLEASE CALL US
<u>DAISY WHEELS</u>		
Olivetti Praxis, 11cps, KSR	480	399
TEC 40, 40cps	1285	995
TEC 55, 55cps	1675	1290
Qume 5/45, 45cps	1720	1449
Qume 9/35, 35cps, KSR	1483	1383
Diablo 630, 40cps plastic/metal wheel	1680	1550
Fujitsu SP830, 80cps plastic/metal wheel	1992	1775

Prices do not include cables or interfaces to computers.
Apple computers parallel graphics or serial £70. Osborne £30.
Limited offer to 30 September.

RAIR GIVES YOU MORE

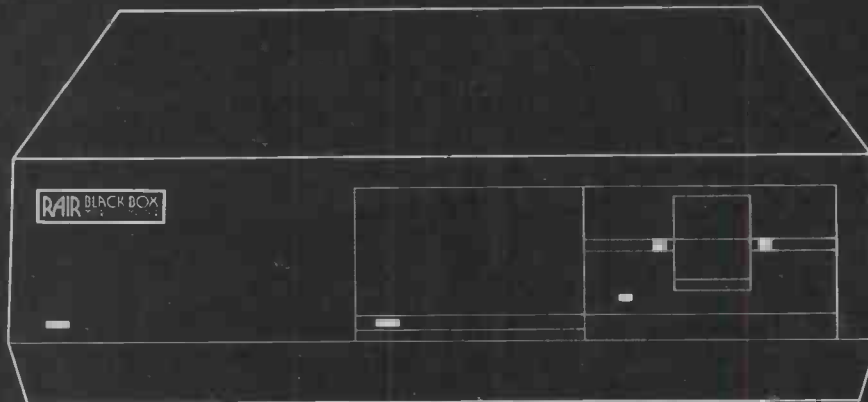

The original 'personal computer'

Now with

Very high speed processor (70% faster)

16 Megabyte disk drive

10/20 Megabyte tape streamer

Mainframe communications software

RAIR

01-836 6921

6-9 Upper St Martins Lane London WC2H 9EQ

Available from

Acorn Microcomputers Wokingham Tel 0734 42220 **ADP Innsite Ltd** Hounslow Tel 01-897 3071
Bestmoor Ltd Nottingham Tel 0602 415315 **British Micro** Dursley Gloucs Tel 0453 3154
Claremont Memories Edinburgh Tel 031 228 6583 **Data Exchange Ltd** Birkenhead Tel 051 647 9185
Dataller Computer Services Ltd Wigan Tel 0942 33493/4 **Derwent Data Systems** Sunderland Tel 0783 652026
FBA Computer Services Ltd Guildford Tel 0483 505799 **Gate Microsystems Ltd** Dundee Tel 0382 28194
Gate Microsystems Ltd Glasgow Tel 041 221 9372 **Gibson Computer Services** Dudley West Midlands Tel 0384 236934
GMS Computing Sheffield Tel 0742 730191 **Johnson Microcomputers** Camberley Surrey Tel 0276 20446
KPG Computer Systems Ltd London W4 Tel 01-995 3573 **Lennon Computer Systems Ltd** St Albans Herts Tel 56 68201
Lion Microcomputers Ltd London W1 Tel 01-580 4581 **Metcalf Microsystems Ltd** London E11 Tel 01-989 0430
Omega Electric Ltd Mitcheldean Gloucs Tel 0452 76532 **RHM Computing** High Harlow Essex Tel 0279 26831
Rockmain Ltd London WC1 Tel 01-404 5958 **Software Ireland Ltd** Belfast Tel 0232 47433
Weir Group Management Systems Glasgow Tel 041 633 2112 Ext 3933
UK Distributor—Thame Systems Ltd Thame Oxon Tel 084421 5471

● Circle No. 118

"The Apple][is limited to 64K RAM..."

(...EXPERT c.1981)



"Rubbish, the fact is ..."

... my Apple][has
128K ^①
and I run
80K Visicalc Models"
(P.A. TO M.D.)



... my Apple][has
192K ^②
and I run
128K Basic Programs"
(PROGRAMMER)



... my Apple][has
320K ^③
and I manipulate
arrays of up to 250 x
250 elements in RAM"
(BOFFIN)



Yes the Apple][once again shows its versatility
– just add U-RAM 16, 32 or 128K RAM boards to your
Apple with appropriate software and you can have
the capabilities the other manufacturers only dream of.

① Basic Apple with one U-RAM 32. ② Basic Apple with one
U-RAM 16 and one U-RAM 128. Chained program. ③ Basic
Apple with one U-RAM 16 and two U-RAM 128.

U-MICROCOMPUTERS

a range of quality peripheral cards to enhance your Apple

We now make more Apple cards than Apple!

PRICE LIST

Boards

U-RAM 16- 16K RAM board ...	£65.00
U-RAM 32- 32K RAM board ...	£85.00
U-RAM 64- 64K RAM board ...	£180.00
U-RAM128-128K RAM board ...	£275.00

Software

Memory Manager 16 (MMS 16)	
DOS relocater for U-RAM16 ...	£15.00
Versa MMS (VMMS)	
DOS relocater for other boards	£15.00
Versa Visi expand (VVE)	
Versatile Visicalc expansion*	£50.00
Versa RAM disc (VRD)	
Versatile disc emulation software DOS 3.3*	£50.00
*Work with U-RAM16, 32, 64 and 128, and multiple and mixed boards.	

Prices exclude VAT.
Order from your local dealer.



U-Microcomputers Ltd., Winstanley Industrial Estate, Long Lane, Warrington, Cheshire WA2 8PR, England.

Tel: 0925 54117/8

Telex: 668920 U-ONE

● Circle No. 119

Software for CP/MTM

MICROPRO

		£
WORDSTAR	MICROPRO's comprehensive word processing system.	250.00
MAILMERGE	Added power to WORDSTAR for mailing lists, standard letters etc	60.00
SPELLSTAR	Dictionary on a disk for WORDSTAR spelling checking.	120.00
DATASTAR	MICROPRO's data entry, validation and retrieval system.	170.00
INFOSTAR	Report Generator for DATASTAR.	N.Y.A.
SUPERSORT I	Sorting, extracting and merging at high speed from MicroPro. Includes Relocatable version for inclusion in your own software	120.00
CALCSTAR	MICROPRO's spread sheet and financial modelling system. Combine with WORDSTAR to get impressive end results.	150.00
WORDMASTER	Video text editor for programmers and simple Word Processing.	60.00

MICROSOFT

		£
BASIC-80	MICROSOFT's popular and powerful BASIC Interpreter (MBASIC).	150.00
BASIC Compiler	Compile your BASIC-80 programs for speed and protection.	190.00
FORTRAN-80	Fortran compiler to ANSI X3.9 1966 except COMPLEX data.	210.00
COBOL-80	The COBOL compiler for microcomputers. (BASIC, FORTRAN and COBOL compilers include MACRO-80, LINK loader, LIBRARY manager and CREF utilities).	310.00

MISC

		£
CBASIC-2	COMPILER SYSTEMS widely used compiler/interpreter for BASIC.	65.00
CB-80	CBASIC compatible compiler.	280.00
PASCAL/M	SORCIM's PASCAL.	120.00
SUPERCALC	SORCIM's spread sheet and modelling system.	170.00
MILESTONE	Project Management and Scheduling from Organic Software.	160.00
dBASE II	Relational Database Management from Ashton Tate.	380.00
MICROSTAT	Statistical program library from ECOSOFT for (and needs) BASIC-80	150.00
NEW PRO PASCAL	PROSPERO's Z80 Pascal true Compiler	190.00

THIS ISSUE'S SPECIAL OFFER

20% OFF any one product ordered at same time as PRO PASCAL (Offer ends 31st August 1982)

Please send large s.a.e. for full details. **TRADE ENQUIRIES WELCOME**

Ordering Instructions: Cash with order. Specify disk format. Add £3.00 per item P&P. Add 15% VAT



the **soft option** (UK) LTD

PO BOX 11 CRANBROOK KENT TN17 2DF (Tel. (058 080) 310

● Circle No. 120

Now you can add 64K CP/M[®] to your Pet Commodore for only £497,- With the CP/M[®]Maker

It takes only five minutes and £ 497,- to raise your standard Commodore operating level by CP/M and add a hefty 64K RAM.

Not another tag-on box, this module actually plugs inside your present console. No new power supply, no soldering, no fiddling.

Whether you own the 3000, 4000 or 8000 series model you can still add CP/M versatility.

The CP/Maker gives you a massive 96K RAM at your disposal.

The Z80 microprocessor, incorporated in the CP/Maker will also enable you to use your 6502 as an intelligent I/O processor.

Look at all these other CP/Maker advantages:

- Compatible with all CP/M software such as wordstar.
- Compatible with all normal CBM software, including 69K Visicalc.
- The Z80 and 6502 work simultaneously.
- Languages include CB 80 (the fastest Basic compiler for micros), C-Basic, M-Basic, MT-Pascal, PL1, CISCobol, Fortran...
- Comes complete with CP/M 2.2 diskette and operating manual.

Enquire at:

Tamsys Ltd.

4 Park Str., Windsor, Berkshire SL41BG
Tel. Winsor 56747, telex 849462 telfac

Micro Technology Ltd.

51/53 The Pentiles, Tunbridge Wells
Kent, Tel. (0892) 32116, Telex 9541

for your local dealer

● Circle No. 121

The
CP/Maker,
a product
from the exclusive
European
supplier of CP/M:

vector
international

Research Park B-3030 Leuven, Belgium
Tel. 016/20.24.96 Telex: 26202 vector

* £ 497,- is a recommended retail price.
CP/M is a registered trade mark licensed
from Digital Research Inc. U.S.A.

New shape for the micro industry?

LAST MONTH'S issue bristled with new "home" computers. We had word of Sinclair's Spectrum, the NewBrain, the Vic-10 and the Vic-30. Epson was showing a neat little machine at Hanover and at the same time rumblings came from the heavy end of the market, with a new 820 rumoured from Xerox with add-on 8086 processor, Sirius-style graphics and improved disc drives. DEC recently announced its range of similar-sounding micros, while IBM potters on with its machine — finding out in the process, it seems, that the micro market is not as simple as it appears from the outside.

For the moment it seems that the wings of the micromarket are pulling ahead of the central body in their advance. Both elements have something to contribute. The question is, will anyone need the central market once they are through? Central market means the moderate-sized businesses which sell moderate-sized machines at moderate prices — the staples of the micro industry as we know it.

The low end is showing that low prices produce staggering volumes. The ordinary rule of thumb is that halving the price quadruples sales — Sinclair's claimed sales figures amply justify that. The theoretical equation — now proved by experiment — would not be very interesting if low price meant low performance.

However, large volumes applied to technology that is expensive in the small quantities of present sales can also produce low prices: for example, the rumoured Rodime hard disc that Sinclair is said to be about to offer for £100. *Practical Computing's* readers are already asking why they should buy Apples at £1,500 when the Spectrum with Microdrives gives the same performance for £300.

What can the big companies contribute to this? Far from selling tens of thousands of units a month, they are happy to sell one or two. In software they look for a profit per package of thousands of pounds as against the £2 or £5 which publishers will earn from the low market. Superficially they look set to go out of business — as our May cover suggested. What they have to offer is a strong tradition of customer hand-holding and the staff to support it. People have long bought from IBM because, at the end of the day, it guarantees that your system will work. It might not work as well or as cheaply as you hoped, but you will not be left stranded.

IBM's success shows that people who buy computers care deeply about this safety net. Human nature being what it is, a similar approach will no doubt work as well in the micromarket as it did with mainframes. Both DEC and Xerox are offering this sort of service.

What about software? In an ideal world there would be a huge base of knowledgeable users who could choose between software products as deftly as they choose between the books and magazines they buy. Unhappily it just is not so. The software market is, and will remain for a long time, very unsteady on its pins. Here again the big companies have a role to play.

So far one has been cynical about their involvement in software. IBM's attitude to outside software authors until the last year or so was somewhat cavalier. They had to assign all their rights to IBM; in return they received a royalty of up to \$10,000, and after that nothing. The implication clearly was that any software worth writing would be written by IBM staff. Well that is quite wrong for the mass market.

Just as the Soviet Union and the United States ought to produce better athletes simply because they have a larger

population in which to look for freaks, so the talent in software ought to be found among computer users rather than inside computer firms. What the big computer companies can usefully do is play the role of the publisher. Just as a good publisher's imprint on a book gives some assurance that the contents are accurate and responsible, so a software publisher ought to assure potential customers that the programs it sells — even if they were not written by the publisher's staff — are still reasonably bug-free, useful and not noticeably illegal.

It seems there is no reason why small companies should not set up in this business and, since much of publishing depends on a single person's intelligence and empathy with the reader, why they should not do the job better than big companies. Yet, they cannot do the hand-holding part effectively. A one or two-or three-man-and-a-dog operation may produce spectacular software, but it cannot field 43 training reps in smart red blazers to show the punters how to make it work.

Perhaps we shall see a three-tier publishing system, in which individuals write programs for small publishing houses who then hope to sell them to the big computer companies which will in turn pass them on to their customers.

At the end of all this, there does not seem to be much of a future for the small computer manufacturers. They lack the volume to compete with the low end and lack the staff and capital to compete with the customer services the big companies can offer. Eventually, one can see the low and high ends coming together, as machines become cheaper for the same power and the customer services learn to do more with less, as knowledge spreads. Then there really will not be any room for anything but the most specialised small manufacturers. It will be like the car industry: at the turn of the century there were dozens of builders, now there are two and a half. So it will be with us.

Finally, a sour-word about the reality of our thrusting Government's support for small enterprises. Readers with long memories may recall a bitter editorial about experiences with the Department of Industry's Software Support Scheme. This, for new readers, is an apparently magical arrangement which will either give you a 25 percent grant or a 50 percent loan, recoverable out of revenue, to write new software.

It sounds like the answer to a software publisher's prayer. Yet as so often with these things, it does everything short of helping. To be given help you have to have some 20 employees, have been trading for five years and have a turnover of half a million pounds. In short, you have to be a member of the Computer Services Association, which is a club of systems houses like Hoskyns, Logica and CAP.

Our editorial seemed to stir up some interest at the DOI and the NCC, which administers the scheme, in broadening it to give help to the small software producer with no one to back him up. But after a year of nothing happening Kenneth Baker, our own minister, has announced more of the same. The not spectacularly successful Software Support Scheme will receive an extra £10 million, and a guidance committee will help to spend it. Who is on the committee? Good old CSA stalwarts. We would be surprised — and very gratified — if they gave any small company the money to write a program that might sell by the tens of thousands to Sinclair users in America and Japan. 

The model of good business.

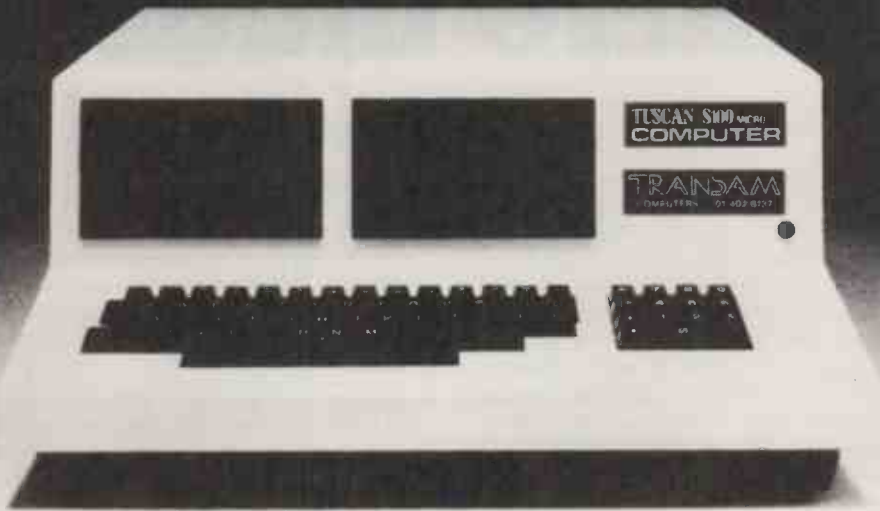

Tuscan – the all-British microcomputer

With a proven record of steady development behind it, the Tuscan S100 now goes a step forward, solving the problem of effective backup storage.

The Tuscan S100, Britain's first S100 computer on a single board, is now available with designed-in mini-Winchester drive for better performance, shorter access time and higher transfer rate. All this from Britain's own home-grown micro manufacturer.

Systems with printer, screen and CP/M start at £2125 with twin floppies, and at £3625 with one floppy and one 5-meg. mini-Winchester.

SOFTWARE. Business accounts packages start at £800 when purchased with the Tuscan system. Word processing packages start at £315; Database packages start at £100.

HARDWARE. Flexibility is the key feature of all Tuscan systems. A choice of storage capacity, video format and graphics is available. The Tuscan S100 can read and write in sixteen different disk formats, with a choice of 5¼" or 8" drives.

SUPPORT. The Tuscan S100, designed and built in Britain, is backed by Transam's substantial experience in electronics plus a dedicated hardware and software team. National third party maintenance is available at ten per cent of hardware costs.

BUSINESS SYSTEM DEALERS. Business Equipment Centre, 10 Edge Lane, Liverpool.

Tel: 263 5783. Contact: Rod Crofts.

Purley Computers, 21 Bartholomew Street, Newbury, Berkshire. Tel: 41784. Contact: Ron Smith.

FURTHER INFORMATION. Two new catalogues covering "systems and peripherals" and "CP/M Software" are available, giving details of our systems and services. Call or write for yours.



TRANSAM

TRANSAM COMPONENTS LIMITED
59/61 THEOBALD'S ROAD, LONDON WC1
Tel: 01-405 5240/2113. Telex: 24224 (Ref. 1422)

● Circle No. 122

microware

The North London Computer Store
Microware (London) Ltd.,
637 Holloway Road, London N19.
Tel: 01-272 6237 01-272 6398



USE YOUR BRAIN

Does it make sense to pay more when Superbrain gives exceptional performance for just a fraction of what you would expect to pay.

Standard Superbrain has from 350K bytes of disk storage and 64K of ram memory.

Its CP/M operating system gives you an overwhelming amount of readily available software in BASIC, FORTRAN, COBOL & APL.

Microware prices are from:

£1495*

*Includes basic and CP/M.

SOFTWARE

Why throw money away when you can buy WORDSTAR at £175.00.

Microware supply a complete range of popular software at prices that are hard to beat including DATASTAR, D BASE II, MAIL MERGE, MAGIC WAND and FULL ACCOUNTING PACKAGES!

any popular software supplied.

PRINTERS

EPSON
MX 80
MX 100

from
£275

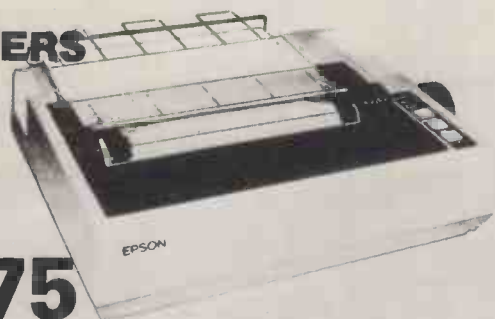

THE NEW SUPERBRAIN™ II
QD

Also available
£1795

THE NEW SUPERBRAIN™ II
1-6M bytes

£1995

THE NEW SUPERBRAIN™ II
(6Mbytes) HD

£3095

ASK FOR LATEST PRICES
ON IBM PC AND
OSBOURNE 1 NOW

Quantity Discounts
Plus Limited Supplies at:

£995

And you should see the prices we can offer on Daisy Wheel Printers. Including QUME, TEC Starwriter, NEC and RICOH.

● Circle No. 123

TEC

Mail Order Software

THE MORE YOU TAKE THE MORE YOU GAIN FROM COMPUTING

MILESTONE: £190

Manual alone: £20.-

"Critical path" network analysis program for scheduling manpower, dollars and time to maximise productivity. NEW IMPROVED. Interactive project management program that runs under CP/M. MILESTONE can be used to track paper flow, build a computer, check a department's performance, or build a bridge. MILESTONE can be used by executives, engineers, managers, and small businessmen.

- Produce PERT chart in minutes.
- Find critical tasks that can't be delayed.
- Investigate tradeoffs between manpower, dollars and time.
- Give plans to others using a printed project schedule.
- Change details and immediately see the results on screen.
- Balance time, manpower and costs.

Requires 56K RAM and CP/M. Specify Z80 or 8080. Also available for Apple Pascal, UCSD Pascal or CP/M-86 operating systems. (Milestone-86 version 290 1) Formats: 8, NS, MP, SB, TRS2, OB-1, XX, IPC, IDW.

ACCESS/80

A report generator and cross-tabulator. Virtually any report that can be described on paper can be generated by using your existing ASCII data files. Produces reports in minutes that would take hours to program in BASIC.

— Level I — Report Generator and Cross-Tabulator — £210.- Manual alone £40

Read ASCII files and create sorted reports with subtotalling capability. Provides multi-dimensional cross tabulation and computation. Includes operating system commands.

— Level II — Output and Logic Processor — £354.-

Manual alone £45

Everything in Level I plus, write out new files in any sorted order (including subtotalling). Load arrays from files. Performs binary search on sorted arrays in memory. Includes control language extensions for complex applications. Requires CP/M and 48K RAM. Formats: 8, NS, MP, CDOS, SB, TRS2, APPL.

DATEBOOK II: £190

Manual alone £18.-

- Schedules appointments for up to 27 different doctors, lawyers, rooms, etc.
- File structure allows for appointments up to one year in advance.
- Searches for openings that fit time of day, day of week and/or day of year constraints.
- Appointments made, modified or cancelled easily.
- Copies of day's appointments can be printed quickly.

Requires 56K RAM and CP/M. Specify Z80 or 8080. Also available for Apple Pascal, UCSD Pascal or CP/M-86 operating systems.

Formats: 8, NS, MP, SB, APPL, TRS2, OB-1, XX, 1-5, IPC, IDW.

QUEST II: L685

Manual alone £350

QUEST II is a database management system for customer lists, inventory lists, employee lists or any kind of internal reporting. It may perform several operations on many datafiles simultaneously.

- Up to 55 datafields within a record.
- Inserting new datafields in an existing file.
- Definition of datastructures in the way of Pascal.
- 9 datafield types including: Date, Longmath (double precision integer and reals), Table (one or two dimensional)
- Definition of screen and printing masks.
- Access on any desired keyfield using up to 15 criterias.
- Sorting in ascending or descending order on up to 15 keyfields.
- Default or user defined printing mask.

— Advanced report generator: writing on screen, printer or disk of all or a subset of records, of a user defined subset of datafields.

— Error messages for fast eliminating of bad entries.

— Two special utilities for error check.

Menu selection with one-key-commands. Full data independence from QUEST-using programs. Full data share ability for minimum access time. Highest access flexibility. Possibility to use QUEST together with your LOGICALC or other programs by loading the also available interface program LOGIQUEST (for complex financial modelling applications like statistics or "what-if?" questions). Format: APPL

PLAN 80: £190 — Manual alone £20

A financial modelling system that's easy to use and powerful enough to replace your timesharing applications. Lets you calculate IRR and depreciation as well as trig functions effortlessly. You write a PLAN 80 model just the way you would write a letter using any editor or word processing program.

Plan 80 results can be incorporated into any report that requires a financial model. It also tackles any numeric problem that can be defined on a worksheet. You'll remember how you created the model because calculations are defined using real English — not matrix coordinates. What if function.

Requires 56k RAM and CP/M. Also available for CP/M-86. Specify Z 80, 8080, or 8086. Formats: 8, NS, MP, SB, OB-1, XX, 1-5.

PERSONAL DATEBOOK — 110. Manual alone 20

Time management and appointment scheduling calendar for an individual or small office with up to nine staff members. Displays one appointment schedule on screen at a time. Cancellations can be put into hold file for easy rescheduling at your convenience. Menu driven commands do not require referral to manual.

Requires CP/M 2.x and 56k RAM. Specify Z80 or 8080. Also available for Apple Pascal, UCSD Pascal or CP/M-86 operating systems. Formats: 8, NS, MP, SB, APPL, TRS2, XX, IPC, IDW.

WHATSI??

A data base/query/retrieval system that communicates conversationally, accepting questions and updates in simple sentences. Store, index and retrieve information about one or more aspects of related or unrelated subjects. Information is stored under your designated "subject" and "tag" headings, which can be added to, changed or deleted at any time. 116 page manual assumes no programming knowledge. Requires CP/M. CBASIC2 AND 24k RAM. Formats: 8, NS, MP, SB, APPL, OB-1, XX

THE FIELD COMPANION £210.-

Manual alone £20.-

Created for the needs of the travelling Salesman or Professional. Allows you to track the time spent with your clients, each client having up to four user-defined subfields. Expense accounting is provided and is itemised in a detailed journal for budgeting and tax reporting purposes. Maintains appointments and current customer list including shipping and billing addresses, year-to-date sales and person to contact for follow-up. Invoicing features retrieves required data from both customer and product lists. Special instructions and discounts are supported. Invoice copies may be output to a printer or sent to the home office via modem, permitting electronic transfer of the content of any report. Requires 56k RAM and CP/M or CP/M-86 and 128k RAM. Formats: 8, NS, MP, APPL, SB, XX, IPC, IDW.

COPYRIGHT:

Access/80 Friends Software; Pearl Relational Systems; Pascal/M, ACT, Trans 86, Supercalc Sorcim, CBASIC 2, CBASIC/86 Compiler Systems; Datebook II, Milestone, Textwriter III Organic Software; Spellguard ISA; CP/M, CP/M-86 Digital Research; Superbrain Intertec Data Systems; S-Basic Topaz Programming; Spellbinder Lexissoft; Selector IV; Selector/86, Gieclor Micro Ap.

Prices quoted do not include dealer installation and training. Prices and availability subject to change without notice.

FOOTNOTE £125.-

Automatically numbers and formats footnote calls, footnotes and text, placing footnotes on the bottom of the correct page. At the user's option, the footnotes can also be removed from the text file to a separate note file. Footnotes can be entered singly or in groups, in the middle or at the end of paragraphs. After running FOOTNOTE the user can re-edit the text, add or delete notes, and run FOOTNOTE again to re-number and re-format. Price includes PAIR, a companion program that checks that underline and BOLDFACE commands are properly terminated. Requires CP/M, WordStar, 48k RAM. Formats: 8, NS, MP, SB, APPL, OB-1, XX.

SPELLBINDER: £260 Manual alone £35.

Full feature word processing system with Office Management capabilities. Its special features include ease-of-use by office personnel, flexible print formatting & output, and powerful macro capability which allows features to be added for the unique requirements of each user. Mail list macro is included for mail merge with form letters.

Requires CP/M & 32K RAM. Formats: 8, NS, MP, CDOS, SB, APPL, XX.

PASCAL/M: £280.- Manual alone £15.-

CP/M compatible language for 8080/Z80 CPUs, supports full Jensen & Wirth plus 45 extensions to Standard Pascal including Random access files, 40 segment procedures & 16 bit BCD real type. Also includes symbolic debugger which features trapping on stores, examining and changing variables and tracing of program execution. Requires CP/M 2.2 & 56K RAM. Formats: 8, NS, APPL, TRS2.

PASCAL/M for 8086/88: £350.-

Manual alone £15.-

All the features of PASCAL/M for the 8086 and 8088 processors running under CP/M-86.

Requires CP/M-86 and K RAM. Formats: 8, 1-5.

PASCAL: Sort - £140.-

Manual alone £14.-

Fully commented source code into which the user simply places the particular file description and sequence requirements to obtain the desired sort. Can run stand-alone or as a overlaid segment of larger program. Uses indirect Shell-Metzner in RAM, interleaved polyphase (Fibonacci) merge on disk, full sector buffering and shortest seek logic. Can match machine language sorts even under Pcode interpretation. Requires CP/M 2.x and 56k RAM and CP/M-86 and 128k RAM. Pascal?M, UCSD Pascal or Pascal /MT. Formats: 8, NS, APPL, XX, MP, TRS2, IPC, IDW.

SUPERCALC: £190

Allows a layman to manipulate business data in a variety of forecasting and accounting applications. Combines the interactive nature of an electronic spreadsheet with the power and convenience of a simple simulation language. Video display can be scrolled over entire worksheet using cursor controls. Symbolic vector reverences eliminate repetitive low level data manipulation commands. Easy to use menu driven "Help" commands. Requires CP/M and 48K RAM. Formats: 8, NS, MP, SB, APPL, TRS2. Call for terminal formats.

SUPERDOS: £100.-

Upgrade of CP/M2.2 for Superbrain. Includes ADM/31 Hazeline, or Superbrain Terminal emulation mode. Other new features include 132 character keyboard buffer, repeat on all keys, key click, user programmable numeric keypad, 30% disk read/write improvement, real time clock, baud rates to 19.2k on RS232 ports, printer handshake modes, 4 new utilities, and 4 fixes. Requires Superbrain 3.0. Format SB.

HITEC

Datenerarbeitung
und Betriebsberatung GmbH

Austria
Zollergasse 15
A-1070 Vienna
Tel 01043-222-934331

ORDERS must specify disk type and format. Add 15% VAT to orders. Add £1 per item for postage and packing. All orders must be prepaid by cheque or money order to HITEC company, Acct. Nr. 12172508 at Barclays Bank International, 16/18 Brompton Road, London SW1X 7QN. COD will also be accepted. Manual costs are deductible from subsequent software purchase. Prices do not include installation and training. Dealers enquiries welcome.

Our Feedback columns offer readers the opportunity of bringing their computing experience and problems to the attention of others, as well as to seek our advice or to make suggestions, which we are always happy to receive. Make sure you use Feedback—it is your chance to keep in touch.

Source list bug

ON ENTERING the Source List program from "Open File: Apple Pie" in June's *Practical Computing* my Silentype printer reeled out great lengths of paper. This unfortunate phenomenon can be avoided by adding a semicolon to line 140, so that it reads:

```
140 GET Z$:PRINT D$;
```

A J Macefield,
Darlaston,
West Midlands.

BBC Basic

I WAS INTERESTED to read the article by John Gordon and Tony Shaw about BBC Basic. They say that there is no command for adding procedures to a program from cassette, and give a method involving playing around with Lomem. Obviously they had not at that stage discovered the commands *Spool and *Exec.

*Exec "prog" presents the contents of a cassette or disc file called "prog", as if it came from the keyboard, and *Spool creates a file of anything which is sent to the screen. So if you have a procedure at line numbers 10,000 to 10,200 which you want to use in another program all you do is:

- *SPOOL "procedure" start the spooling action
- List 10000, 10200 output procedure to file
- *SPOOL stop the spooling program to which procedure is to be added
- LOAD "program"
- *EXEC "procedure" overlay the procedure; note that common line numbers will be overwritten

This is much easier and safer than messing around with Lomem, though with the 0.1 version of the machine operating system *Exec does produce spurious error messages, which should simply be ignored. Acorn says that in the 1.0 version of the operating system this command will have been tidied up a bit.

Paul Beverley,
Norwich.

Tachistoscope tapes

MY COMPUTER TACHISTOSCOPE article published in April's *Practical Computing* provoked surprisingly strong interest. At the end of the article I offered to supply a machine-readable copy of the program to any educational establishment sending a cassette or disc and return postage. Un-

fortunately several people who replied were under the impression that a machine-readable copy meant that any machine could read the program.

It is a sad fact of life that the many computers now available all use different systems for program storage and that a tape produced by one make of computer is not readable by any other. It is a veritable tower of Babel. Even if the Basic commands are similar the program as published will only run on the TRS-80 Model I.

However, in response to various requests I now have available the Tachistoscope program for the following TRS-80 models I and III, BBC Micro models A and B, and Pet machines. May I now extend my offer to any educational establishment to supply the program for any of these computers? Please write on headed note paper enclosing cassette and return postage.

Unfortunately I cannot extend this offer to the general public, but would nevertheless be very grateful for any comments as to how the program has been received by the teacher and pupils. Adverse and negative comments are as useful as praise, as only through such feedback is it possible to design programs that have a useful function and that are usable by non-computer personnel.

M K Cook,
Manchester.

WordStar trick

READERS MAY be interested in how I have overcome, fortuitously, what I regard as one of the principal deficiencies of WordStar, otherwise an excellent piece of software. As written, the program does not underline spaces and this gives text a very peculiar look indeed — see the Instruction Manual for an example of how untidy it looks.

Quite by accident, I entered a Control-PF instead of a Control-PS to terminate an underlining and printed. The space where I had typed Control-PF was underlined! I consulted the manual, and the excellent *Introduction to WordStar* by Arthur Naiman, and found that I had typed in a phantom space the exact graphic result of which, in the words of the manual, "depends on the print wheel in use". I am printing on an NEC 3500 so I am perhaps just lucky.

I had, incidentally, written to MicroPro about the underlining deficiency and the company was simply not interested. I was referred to the dealer from whom I had

bought my program. I would have thought that this defect should be remedied, if at all, at source. But other WordStar users might like to try this trick with their daisywheel printers and they might be as pleasurably surprised as I was.

Dafydd Evans,
Hong Kong.

First sighting

I SAW my first Spectrum of summer on Friday 2nd July 1982.

Is this a record?

I Higton,
London E17.

That man again

I WAS INTRIGUED to see the correspondence in the May 1982 issue of *Practical Computing* on the merits or otherwise of languages and the example called Drunken Duncan. Here is the near equivalent code in APL which runs on a 64K micro.

Clear and Cursor are functions supplied by Micro APL, and their use is self-evident. No APL random number code is needed; the symbol ? does that. No decision is involved in moving the cursor; the current position P is updated on each entry to the line labelled Step and on being updated is tested to see if it is outside the range specified.

Line 20 sets the start position — 10, 15 in this case — the non-zero limit D, and initialises the counter N to 0 in a fairly compact way. The only other point to note is that this formulation causes the cursor to move in one of eight random directions: NE, NW, SE, SW are included.

Doubtless APL fans will have fun squeezing it on to only one line and will regard Forth, Comal, Fortran, Pascal, Basic, Coral, Cobol and all the others as tedious and cumbersome to write. But I agree with Frank Dale; it is a question of horses for courses.

John Steel,
Leatherhead,
Surrey. □

Duncan in APL.

```
?DUNCAN![]?
?DUNCAN:D
[10] CLEAR
[20] N←1+0=D÷2×P÷10 15
[30] STFP:×(1=÷(P>D)÷0)P←P+~1+3 37100÷N+N+1)/0
[40] CURSOR P
[50] 'x'
[60] +STEP
▽
```

COLUMBIA

A complete range of microcomputers from 320K-80M

Single and multi-user upgradeable/expandable microcomputer systems from Columbia Data Systems offer the disk storage capacity that's exactly right for you. Single user machines to take 5¼" or 8" floppy disks giving 320K-2.4M capacity and multi-user machines with up to 80M on hard disk.

Up to 5 users can work simultaneously while sharing a single processing system. Ideal for word processing, general accounting or other special purpose business applications.



Icarus handle the whole range of microcomputer systems produced by Columbia Data Systems of the U.S.A. This includes CP/M and MP/M single and multi-terminal units with hard and floppy disk storage capacities. It is adaptable to suit each and every micro-based application there is. So whenever you need a microcomputer, for whatever purpose, Columbia and Icarus have the answer.

The Icarus dealer network

A.P. LTD, Maple House, Mortlake Crescent, CHESTER CH3 5UR.
Tel: 0244 46024

BASIC BUSINESS SYSTEMS, 61 Loughborough Road, WEST BRIDGEFORD, Nottingham.
Tel: 0602 819713

BUSINESS INFORMATION SYSTEMS, 602 Triumph House, 189 Regent Street, LONDON.
Tel: 01 437 1069

BORDER COMPUTING LTD, Dog Kennel Lane, BUCKNELL, Shropshire. Tel: 054 74 368

CAMBRIDGE MICRO COMPUTERS, Cambridge Science Park, Milton Road, CAMBRIDGE.
Tel: 0223 314666

COMMONSENSE COMPUTING LTD, P.O. Box 7, BIDEFORD, Devon. Tel: 02372 4795

COMPUTECH SYSTEMS, 168 Finchley Road, LONDON, NW3 6JF. Tel: 01 794 0202

CONQUEST COMPUTER SALES LTD, 92 London Road, BENFLEET, Essex. Tel: 03745 59861

CULLOVILLE LTD, Thornfield, Woodhill Road, SANDON, Chelmsford, Essex. Tel: 024 541 3919

DATA PROFILE, Lawrence Road, Green Lane, HOUNSLOW, Middlesex. Tel: 01 446 1917

DATA WARE, 48 Eaton Drive, KINGSTON, Surrey KT2 7QX.
Tel: 01 546 2984

DAYTA, 20b West Street, Wilton, SALISBURY, Wiltshire. Tel: 0722 74 3898

DRAGON SYSTEMS LTD, 37 Walter Road, SWANSEA, W. Glam. Tel: 0792 474498

DUPLEX COMMUNICATIONS, 2 Leire Lane, Dunton Bassett, Lutterworth, LEICESTERSHIRE.
Tel: 0455 209131

ELSTREE COMPUTING LTD, 12 Elstree Way, BOREHAMWOOD, Herts. Tel: 01 207 2000

ESCO COMPUTING LTD, 154 Cannongate, EDINBURGH.
Tel: 031 557 3937

ESCO COMPUTING LTD, 40a Gower Street, GLASGOW G51 1PH. Tel: 041 427 5497

EFFICIENT BUSINESS SYSTEMS, 9 Clarence Street, BELFAST 1, N. Ireland. Tel: 0232 647 538

EMTEC COMPUTERS LTD, 40 South Furzeham Road, BRIXHAM, Devon. Tel: 08045 3566

FAST COMPUTING, 52 High Street, HENLEY-IN-ARDEN, West Midlands. Tel: 01 438 2813

B. FITTON, 97 Melbourn Road, ROYSTON, Herts. Tel: 0763 41949

FOREST ROW COMPUTERS, 53 Freshfield Bank, FOREST ROW, East Sussex. Tel: 034282 4397

J & F GROVER LTD, 10 Barley Mow Passage, LONDON W4 4PH.
Tel: 01 944 6477

G.I.C.C., P.O. Box 519, Manama, Bahrain.

JAEMMA LTD, Unit 24, Lee Bank House, Holloway Head, Lee Bank, BIRMINGHAM. Tel: 021 643 1609

JENNINGS COMPUTER SERVICES, 55/57 Fagley Road, BRADFORD, W. Yorks. Tel: 0274 637967

KENT BUSINESS SYSTEMS LTD, 85 High Street, Ramsgate, Kent. Tel: 0843 687816

LAWMAR BUSINESS SYSTEMS, 1 Paterson Drive, Woodhouse Eaves, LOUGHBOROUGH, Leics. Tel: 0509 899090

LONDON COMPUTER CENTRE, 43 Grafton Way, LONDON W1. Tel: 01 388 5721

M.G. ENTERPRISES, 32 Rue Victor Hugo, 92800 Puteaux, France. Tel: 0103315060655

MASS MICROS, Wellson House, Brownfields, WELWYN GARDEN CITY, Herts. Tel: 96 31736

MICROAGE LTD, 53 Acton Road, LONG EATON, Nottinghamshire. Tel: 06076 64264

MICROSERVE LTD, 811 Kennedy Way, Pelham Road, IMMINGHAM. Tel: 0469 72346

MICROCARE COMPUTING LTD, 18 Hawarden Road, NEWPORT, Gwent. Tel: 0633 278040

MICROCOMPUTER CONSULTANCY, Lyngen, Oldhill Wood, Studham, DUNSTABLE, Beds. Tel: 01 351 2488

NASTAR COMPUTER SERVICES LTD, Ashton Lodge, Abercrombie St., CHESTERFIELD. Tel: 0266 207048

NICOMTECH LTD, The Old Mill, Anthony Passage, SALTASH, Cornwall. Tel: 07555 2719

OMEGA ELECTRIC LTD, Flaxley Mill, Flaxley Road, MITCHELDEAN, Glos. Tel: 045 276 532

PROTOCOL COMPUTER PRODUCTS, 49 Beckenham Lane, Shortlands, BROMLEY, Kent.

RANMOR COMPUTING LTD, Nelson House, 2 Nisson Mews, SOUTHEAST-ON-SEA. Tel: 0702 339262

ROGIS SYSTEMS LTD, Keepers Lodge, Frittenden, NR. CRANBROOK, Kent. Tel: 058 080 310

S.D.M. COMPUTER SERVICES, Broadway, BEBINGTON, Merseyside L63 5ND. Tel: 051 608 9365

SAPPHIRE SYSTEMS, 19-27 Kents Hill Road, BENFLEET, Essex. Tel: 03745 59756

SHEFFIELD COMPUTER CENTRE, 227 London Road, SHEFFIELD S2 4NF. Tel: 0742 53519

SISCO LTD, 4 Moorfields, LONDON, EC2Y 9AA. Tel: 01 920 0315

SORTFIELD LTD, E. Floor, Milburn House, Dean Street, NEWCASTLE-UPON-TYNE. Tel: 0632 329593

SPOT COMPUTER SYSTEMS LTD, New Street, Kelham Street Indus. Estate, DONCASTER, S. Yorks. Tel: 0302 25159

STAG TERMINALS LTD, 30 Church Road, Teddington, Middlesex. Tel: 01 943 0777

STUKELEY COMPUTER SERVICES, Barnhill, STAMFORD, Lincs. Tel: 0780 4947

TERMACRE LTD, 126 Woodwarde Rd., LONDON SE22 8TU. Tel: 01 693 3037

THAMES VALLEY COMPUTERS, 10 Maple Close, MAIDENHEAD, Berks. Tel: 0628 23552

TURNKEY COMPUTER TECHNOLOGY, 23 Calderglen Road, St. Leonards, EAST KILBRIDE. Tel: 03552 39466

WORD PERFECT, Old Town Hall, Box 148, READING, Berkshire. Tel: 0734 589068

For further details, or if you want to become a dealer yourself, contact:

Icarus Computer Systems Ltd. Deane House 27 Greenwood Place London NW5 1NN Tel: 01-485 5574 Telex: 264209

● Circle No. 125

S-100 MULTI-USER MULTI-PROCESSOR HARDWARE

Each user running standard CP/M2.2 or CP/M86 with zero CPU degradation.

SuperStar

Upgrade package is available for:
 — North Star Horizon
 — Comart Communicator
 — Vector Graphics
 and other S-100 systems

DESKTOP COMPUTER PACKED WITH:

PROCESSING POWER

Up to 16 users each with its own private card which contains Z80A, 64 KBytes, VDU i/o and printer i/o, ie total of 16 Z80s and 1024 KBytes of RAM. (Optional 16 bit 8086 processors with 128 KBytes).

STORAGE

Integral 5.25" Winchester Disc with up to 15 M Byte capacity and integral 5.25" Floppy Disk with up to 800 KByte capacity. Optional — 14 MByte cartridge tape back-up unit, up to 80 MByte Winchester Disk Unit.

HIGH PERFORMANCE

Unlike single — CPU multi-user systems (eg. MP/M, MVT-FAMOS, OASIS, etc.) where system throughput degrades as additional users are added, Superstar has no CPU degradation at all. Each user has its own private processor and memory and VDU i/o running at 4MHz.

PRINTER INTERFACE

1 serial and 1 parallel printer ports shared by all users plus a private printer for each user.

16 BIT 8086 PROCESSOR

More power and faster processing time is offered through 16 bit private processor card based on 8086 CPU and 128 KByte RAM expandable to 1 MByte. The system automatically loads CP/M 86 to the 16 bit private processors.

The revolutionary Super Star is the only system that allows the total integration of powerful 16 bit 8086 processors with the more standard Z-80 user processors. The system may be configured in any 8 bit/16 bit combination, or as a totally exclusive 16 bit system only to provide the ultimate in performance and flexibility in advanced micro systems.

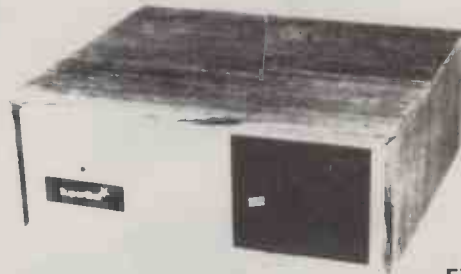

NEW
FEATURES
YET
LOWER
PRICES

SYSTEM SOFTWARE

Each user processor runs its own dedicated copy of the industry standard CP/M 2.2 or CP/M 86. Shared resources (Disks and Systems Printers) are controlled by DPC/OS which supports file/record locking, print spooling, multiple printers and interprocessor communications. Language available: BASIC, COBOL, PASCAL, FORTRAN, PL/1, API.

APPLICATIONS SOFTWARE

Word Processing, Sales, Purchase, Nominal Ledger, Payroll, Order Processing/Invoicing, Stock Management, Job Costing, Mailing System, Insurance Brokers System etc.

LOW COST (FROM £1750) AND EXPANDABLE (AS YOUR NEEDS GROW)

Superstar starts at £1750 for single user system. Quad density floppies and it is field upgradable to hard-disk system of up to 80 MByte capacity and by simply adding a private processor card for each user the system can be configured into multiple users as and when required. The 16 bit processor is fully compatible within the standard Superstar multiprocessor system permitting efficient upgrading as future needs develop, without sacrificing any of your extensive hardware and software investment.

CP/M MULTI-USER MULTI-PROCESSOR SOFTWARE

WILL RUN UNDER CP/M 80, CP/M 86,
 DPC/OS or MmmmOST
 (ie any CP/M machine)

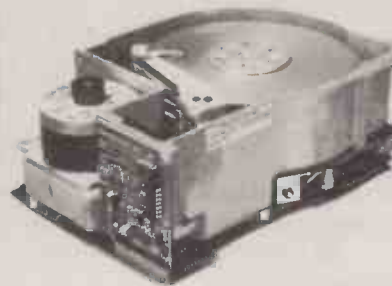
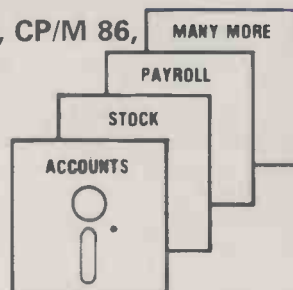

Each package is available:
 — Stand alone
 or Integrated
 — Single-user
 or Multi-user
 — Floppy or
 Hard Disk based

SuperStar PROGRAMS

Standard Packages:

- Stock Control
- Order Processing
- Sales Ledger
- Purchase Ledger
- Nominal Ledger
- Payroll
- Job Costing
- Mailing System
- Word Processing

Specialised Packages:

- Wholesale/Retailing
- Insurance Brokers
- Bookmakers
- Industrial/Office Cleaners
- Property Management
- Importing Agency
- Manufacturing Control System
- Underwriting Agents
- Variable Rental System

General Features

- Menu driven
- Interactive
- Password protected
- Modular structure
- Full Screen Control
- Easy to use
- Professionally designed
- Field proven over the years
- Expandable

Bromley Computer Consultancy specialises in the cost effective application of micro technology. Our services include feasibility study/system analysis, systems development, installation, training, consultancy and maintenance. Systems supplied range from 8 or 16 bit processor based floppy system to 80 MByte multi-processor systems.

Bromley Computer Consultancy

PROFESSIONAL APPROACH TO MICROS

244A High Street, Bromley, Kent BR1 1PQ.

Telephone: 01-464 8080 Telex 896691 TLXIR G (Attn. "BROMCOMP")

OEM, DEALERS AND OVERSEAS ENQUIRIES WELCOME

Superstar is a trademark of Bromley Computer Consultancy. CP/M is a trademark of Digital Research.

● Circle No. 126

Marine caps a success

CAP'S SEAVIEW work stations have successfully communicated with each other via satellite. SeaView is the world's first viewdata-based electronic office for use at sea, and has been developed by CAP in conjunction with the Department of Industry, British Telecom and Siemens. The addition of satellite capability now offers some interesting new possibilities.

CAP's manager of maritime systems said of the trials that CAP is "delighted" at the ability to offer data-communication facilities, not just over short distances but worldwide. One work station is currently installed on the British Telecom marine cable ship *Alert*, operating out of Southampton. Two other work stations are located at CAP's Reading offices.

Two-way data transfer using satellites was achieved between the *Alert* work station and a work station in Reading. Viewdata-type pages were exchanged using the Inmarsat geostationary satellite.

As well as accessing U.K. Prestel, both the Finnish and Hong Kong viewdata systems were accessed, the shipborne system being operated by non-expert ship personnel. ■

Coming events

Computer Laboratory Annual Microprocessor Workshop: £72.00 per delegate; September 6/7 at the University of Liverpool. Telephone: 051-709 6022.

Can Micros Work For Me? £91 + VAT; October 14-15 and December 9-10 at Hull College of Higher Education. Telephone: 0482 41451 x 358.

The Northern Computer Fair: Personal Computers, Home Computing, Small Business Systems, Belle Vue, Manchester, November 25-27.

Programming my Micro: £65 + VAT; Eight evenings from October at Hull College of Higher Education. Telephone: 0482 41451 x 358. ■

Xerox pushes on



RANK XEROX is persevering in its efforts to break into the business micro market with the Mark II version of Xerox 820, which was launched last winter. The new machine is basically a Z-80, CP/M "cooking" machine, but with a well-graduated range of disc and other options.

The cheapest version, with 5.25in. drives, starts at £2,150. There are also 8in. drives, and double-density options are available on both sizes. Also

on offer is a 5.2-in. Rodime hard disc offering 6Mbyte, and an 8in. Shugart with up to 34Mbyte.

Xerox has solved the tricky 16-bit question by offering an 8088 board for £500 — a more sensible solution than building a 16-bit machine and then offering a Z-80 board to let it do useful work. Users can now move up as and when they need to. There will be a high-resolution, 1,024-by-512 graphics board, and an extra

32K for the Z-80 machine.

The system includes a comprehensive configuration utility which allows, for instance, the specification of a CP/M command line to be executed when the machine starts up. There are terminal emulation routines in firmware, so the machine can pretend to be a terminal without any extra programming.

A range of printers, from the Epson dot matrix up to the Diablo daisywheel can be supplied. Simple networking will be offered on the 16-bit version, and there will also be an interface to Ethernet.

The 820-II seems a reasonably mature machine in the mainstream of current business micro ideas. More interesting perhaps than the hardware is the support that Xerox claims to give it: building on its large organisation. Xerox intends to have nationwide service and support.

Even if there were nothing else to make the machine attractive, the name on the box must give the customer some confidence that it will be mended if it goes wrong. As well as hardware support there is a "Helpline" telephone, manned by engineers and software people, which any user can ring for advice. ■

Stay-home poll

WILL THE HOME COMPUTER bring new opportunities to those whose responsibilities keep them housebound? Or will it simply perpetuate the low wages and isolation which is commonly the lot of women working at home? These are just two of the questions which have prompted a research project, funded by the Equal Opportunities Commission, which will examine the position of the new homeworkers.

Ursula Huws, author of *Your Job in the Eighties: A Woman's Guide to New Technology*, published recently by Pluto Press, is conducting the research and plans to contact

as many homeworkers as possible during the year. If you work at home as a programmer or a systems analyst, or if you operate a word processor or perform any other function connected with new technology — or if you work for a company that operates in this area — please contact Ursula Huws. All replies will be dealt with in strict confidence, and there is no expense involved.

Write to her at Freepost, London N1 2BR (no stamp required) and she will send you a questionnaire to complete. No further contact will be made unless you wish. ■

This is a high-quality, high-speed analogue-to-digital converter which plugs into the user port at the rear of the Commodore Pet computer. The device comes with four multiplexed input channels, with a conversion time of around 50µs. There is a provision for trigger inputs which allow control of the A-D conversion. A versatile operating system is provided in EPROM, which allows discrete conversions from Basic. Up to 15,000 readings may be entered. The converter costs £195 from CIL Microsystems Ltd, Decoy Road, Worthing, Sussex. Telephone: (0903) 210474. □



20K ROM module

JUST NINE months after it was originally promised the 20K BBC ROM conversion for the Acorn Atom is available. It supports the full set of BBC Basic commands, and is syntactically identical so that any program that does not rely on the BBC Micro's hardware can be run on an otherwise unmodified Atom.

The module works in parallel with Atom Basic and can be selected either by a switch or from the keyboard. It contains a 16K Basic ROM, a 4K operating system ROM and an additional 2K RAM. It also comes with a manual.

The module alters the Atom memory map so that RAM is available from 0000 upwards.

The module costs £49.95 including VAT and is available from Acornsoft, 4a Market Hill, Cambridge. Telephone: 0223 316039. □

Reader survey

THE RESPONSE to *Practical Computing's* reader survey ran into several thousands, and more replies are still turning up every day. Many were accompanied by letters, most of them kind, but one reader was concerned about the security of our survey. There is no need to worry: the list of names and addresses will not be supplied for outside use.

The winners of the prizes are: Colin Hogben of Folkestone, in Kent, who received £50, and N S Hutchison of Bicester, Oxfordshire and T Wright of Bromsgrove, Worcestershire who each received £25.

Many thanks to everyone who took the trouble to complete the questionnaire. □

32-bit micros set to invade industry

THE 16-BIT micro has been with us for some time now, and a number of 16-bit systems have found their way into various microcomputer installations. Now it looks as though these machines are to be upstaged by a new generation of 32-bit micros. Industry rumours say that Hewlett-Packard has a 32-bit machine on the way, to be joined by a 32-bit micro developed by Acorn in conjunction with National Semiconductor.

The chip comes from National Semiconductor and is claimed to be the only true 32-bit microcomputer. It is capable of supplying the user

with the power of a mini-computer at about 10 percent of the cost.

This chip, and the others in the series, are to be incorporated by Acorn into two new products. As a second processor for the BBC Micro, it will come on a board with 256K of RAM and an operating system in ROM. The interface to this processor will be handled by the "tube".

The second product comprises the processor, up to 1Mbyte of RAM and one or two 5Mbyte Winchester discs, together with a specialised operating system which allows the user to connect it to an

existing microcomputer, such as a Pet, Tandy or Apple, which can be used as a terminal. Communication is through a simple RS-232 link.

There is already an extensive selection of software support. Users will have the choice of Acorn, Unix or Idris operating systems together with a wide range of programming languages. Digital Research is currently developing a multi-tasking version of the CP/M operating system for the new chip.

Acorn expects to market this product worldwide to the existing user base of over 2,000,000 Apple, Pet and Tandy machines. The proposed name of the device is the Glueon — particle physicists, please note. □

Technology films

JOHN CLEESE stars in Video Arts' latest training film. *What is a Word Processor?* Scripted by David Nobbs, writer of the Reginald Perrin series, the film is a comedy about two boss-secretary teams, one with a word processor, one without.

The film is a joint production between IBM and Video Arts, which has John Cleese as one of its directors. It is aimed at both managers and secretarial staff in companies thinking about introducing word processors, and in general emphasises the benefits technology brings.

By contrast, Education Media's new film *New Technology — Whose Progress?* looks at the drawbacks. It examines job loss and job changes following the introduction of new equipment into

offices and factories, and is concerned not just with computers but with developments in robotics and communications. Tony Benn, trade unionist Mike Cooley, and Richard Sharpe, the editor of *Computing*, appear in the film.

What is a Word Processor? runs for 28 minutes and costs £56 to hire or £359 to buy. It is available as a 16mm. film or on VHS or Sony Umatic video cassette, from Video Arts, Dumbarton House, 68 Oxford Street, London W1N 9LA. Telephone: 01-637 7288. *New Technology — Whose Progress?* runs for 35 minutes and costs £13 to hire on VHS, Sony Betamax or Sony Umatic cassette, or £18 on 16mm. film, from Concord Film Council, 201 Felixstowe Road, Ipswich, Suffolk IP3 9BJ. Telephone: (0473) 76012. □

Briefcase viewdata

BRIEFCASE VIEWDATA is the latest product from Tandata Marketing. It gives the user access to Prestel or private viewdata systems from any telephone in the U.K. The system consists of a Alpha Tantal adaptor and an acoustic coupler, which means that a user does not need a jack point.

Prestel or viewdata users are therefore now able to make use of the facility wherever they have access to a telephone and a television.

The complete Briefcase Viewdata weighs only 5lb. and costs £449. Contact Tandata Marketing, Clyde House, Reform Road, Maidenhead SL6 8BU. Telephone (0628) 74661; Prestel 799. □

INNOVATIVE TRS 80-GENIE SOFTWARE

from the professionals

AJEDIT



**..... a new, simple to use,
moderately priced word processor..**

AJEDIT was introduced as a new word processor some months ago, having been written with ease of use as a prime design requirement. Since then it has achieved market success, so much so that it has gone through two additions, together with the introduction of a Manual specifically aimed at the first user. The documentation now totals about 60 A4 pages.

Arrangements have now been made with Logical Systems, Inc. of the United States, the authors of the LDOS disk operating system, for the inclusion in AJEDIT of a stripped-down version of this disk operating system, called smal-LDOS. This gives to AJEDIT a number of major benefits. For instance it now incorporates "type ahead". This means that if you are typing into the word processor whilst the machine is looking at something else, input is stored and then accepted by the program at its own convenience. One of the major advantages of this, of course, is that it is now pretty well impossible to outstrip AJEDIT in speed, particularly at the most critical end of line time, when the program is very busy tidying up. A further improvement given by the marriage between AJEDIT and smal-LDOS is the key repeat function. If the user's finger is kept on a key for longer than a certain time, then that key will repeat on the screen or, if it is a control key, its function will repeat. Both the delay time before the repeat starts, and the rate of repetition is adjustable. Yet another improvement is the addition of a screen print facility so that at any time the operator may (for instance) print out his source file from the screen, complete with all control characters.

To some users these additional functions and others, such as double density support, will not be of the greatest importance and as the smal-LDOS version of AJEDIT is higher in cost, we will be continuing the previous version.

Both versions of AJEDIT contain close to 100 commands, covering most word processor requirements, including two sets of dedicated printer commands for the Epson MX series and Centronics 737 machines. Three principle advantages of AJEDIT over some other word processors are the ability to access DOS commands from within AJEDIT, the facility to mail merge (whereby a names, addresses and salutations file can be married up to a standard letter), and most important of all, the fact that AJEDIT commands are so constructed that they are easily remembered by intermittent users.

AJEDIT needs 48K and one disk minimum, and is presently suitable for the TRS-80 Models I and III together with the Video Genie Models I and II.

Standard AJEDIT	£49.95
smal-LDOS AJEDIT	£79.95

Both prices inclusive of V.A.T. and P. & P.



MOLIMERX LTD

A J HARDING (MOLIMERX)

1 BUCKHURST ROAD, TOWN HALL SQUARE, BEXHILL-ON-SEA, EAST SUSSEX.

TEL: [0424] 220391/223636

TELEX 86736 SOTEX G

TRS-80 & VIDEO GENIE SOFTWARE CATALOGUE £1.00 [refundable] plus £1 postage.



● Circle No. 127

Zap into music

ZAPPLE is a board which will turn an Apple II micro-computer into a musical instrument. The Zapple, which comes complete with its driving software, works by using sound tables, created in a similar way to the shape tables.

A wide range of sound and musical effects is possible. The Zapple is equipped with a number of programs which make table creation easy, sounds being produced with one simple command.

The board is self-contained and includes the well-known AY-3-8910 programmable sound-generator chip, software in an on-board EPROM and a volume-controlled audio amplifier which can connect to the Apple speaker. Other fea-

Sinclair languages

ONE OF the problems of using the ZX-81 is that Sinclair Basic, whatever its other merits, is slow. Writing in machine code is one answer for programmers, but this only produces fast code at the cost of much greater programming effort. Furthermore, the ZX-81 provides no machine-language monitor so the whole procedure is unnecessarily tedious.

What is needed is a fast, high-level language for the ZX-81, and to this end Artic Computing of Hull has come up with ZXForth, a version of the Forth language originally developed for controlling the tracking mechanism of telescopes. It is ideal for micro-computer applications as it produces code which executes rapidly but which is also very compact.

Artic's offering implements the Fig-Forth subset. Unlike Basic, Forth is relatively transportable between different machines because most versions of Forth conform to this standard.

ZXForth costs £135 on cassette and £70 on EPROM. Contact Artic Computing, 396 James Reckett Avenue, Hull, North Humberside HU8 0JA.

tures of the unit include sockets to plug in other sound-generator chips. This facility enables the number of voices to be increased from three to nine. There are terminals for connection to an external amplifier or speaker.

The Zapple will run with any size Apple II with disc or tape, and sells for £65. Further details are available from Meekrose Ltd. Telephone: 0525 370621.

The Econotech 16K RAMpack is the cheapest memory expansion for the ZX-81. Measuring about 2 in. by 3½ in. the Econotech RAMpack is the ultimate no-frills expansion for the hobbyist. The pack uses NMOS dynamic RAMs, which are economical on both power and space. It is compatible with the Sinclair ZX printer and is supplied together with a six-month guarantee. Econotech, 30 Brokenhurst Way, London SW16 4UD.

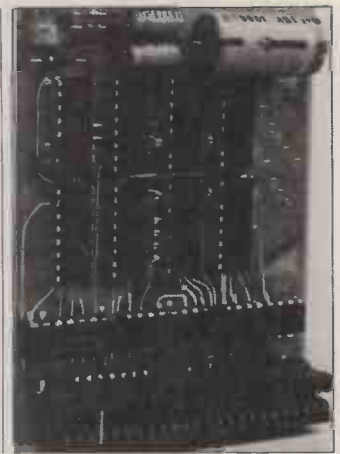

Computing holidays

THIS YEAR sees a record number of residential and non-residential courses aimed at teaching children about computers. Among them are those run by Beaumont Summer Camps, 100 New Kings Road, London SW6 6LX, telephone 01-736 3272, an established operator of the traditional riding, fishing and canoeing sort of camp. This year it is adding computers in the form of three-hours-a-day instruction, taking in Basic programming, computer games, and word processing using Commodore Pets. A week for a 10-to-17-year-old costs around £170 at Beaumont's Carlisle camp, and bookings run up to the end of August.

Beaumont is also running weekly Monday to Friday non-residential camps at Windsor, Sevenoaks and Mill Hill. Children will be bussed in daily.

Interface for Vic-20

AN INTERFACE has been developed to connect the Commodore Vic-20 microcomputer to a radio transmitter or receiver. The interface simply plugs in to the rear of the Vic, or if the computer has an expansion system, it fits into that.

The 4K of machine-code program needed to drive the interface is contained in EPROM. The card also contains a Morse and RTTY converter and decoder making it possible for the Vic to transmit or receive RTTY or Morse signals. On RTTY there is a choice of baud rate varying

The daily camps cost around £100 per week and cater for 5-to-15-year olds.

Dolphin Camps, 8-10 Parkway, London NW1, telephone 01-267 6926, is running courses in association with Beaumont, at Carlisle, Sevenoaks and Mill Hill. Dolphin is oriented more towards the older 10-to-18 age group — parents can be smuggled in — and has obtained a £15-a-week subsidy from the Department of Industry for the non-residential courses, so their prices are slightly lower. A range of other technology activities, including film, animation, video, robotics and psychobionics is also on offer. The computers used are Apples at Mill Hill and Acorn/BBC machines at Sevenoaks.

Aldenhams School, Elstree, Hertfordshire, telephone 01-779 7553, is organising non-

residential weeks, running from the end of July to the end of August. For £94 for 9-to-13-year olds, and slightly less for younger ones, the children get two hours a day of computer instruction from the school's term-time staff on TI 99/4s. The rest of the time is spent on sports, sailing, drama, etc.

London Computer Summer School, Mortimer House, 37-41 Mortimer Street, London W1N 7RJ, telephone 01-886 4292, is running courses for 13-year olds upwards at Middlesex Polytechnic's Trent Park campus in Enfield. The cost for a week of five days is £150 non-residential and £195 residential; seven-day courses cost £195 and £265 respectively. The courses are intensively focused on computing, though sporting and recreational facilities are available. The machine used is the Vic-20, and bookings run up till mid September.

A much more laissez-faire approach is favoured by Concorde Holidays, 25 Fore Street, Praze-an-Beeble, Camborne, Cornwall TR14 0JX, telephone (0209) 831274. Concorde has designated September 25 to October 1 as Computer Holiday Week at Bude Holiday Park — golf, sailing and surfing available — where £60 secures a caravan for six people. The idea seems to be that you descend en masse, taking your computer along with you. "No doubt many friendships will be struck up and a great deal learnt from each other" the brochure hopefully puts it.

At KGB, we believe in putting pen to paper.

MICROPLOT is a CP/M Graph Drawing Package
 interfacing with A4 size flat bed plotters
 Ideal for business and engineering applications

A comprehensive GRAPH configuration

- * axes may be user defined or automatically fixed
- * data points may be defined or suppressed
- * straight joining lines or curves, the latter from complex calculations automatically executed
- * up to eight colours available
- * up to seven broken line patterns

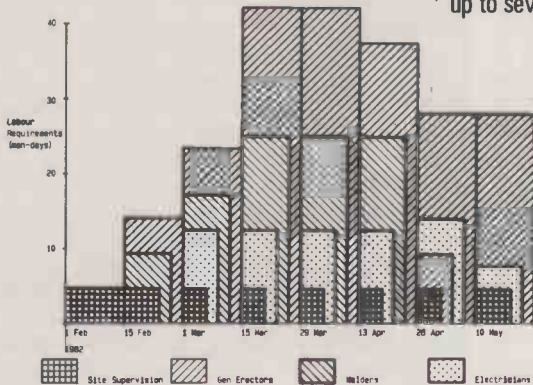

Example of a Numerical Axes Graph.

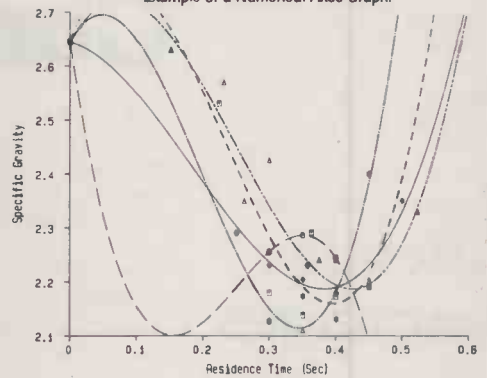

A correctly proportioned HISTOGRAM configuration

- * operates like GRAPH but structures in block format
- * various shading patterns available

A quickly drawn PIE configuration

- * created from very simple input
- * legends located in or outside boundary
- * segments can be shown withdrawn
- * various shading patterns offered
- * up to eight colours available

No screen necessary **MICROPLOT** draws on paper for reports or on film for overhead projection. Will also interface with Supercalc and Micro Modeller. Single or multi coloured plotters supplied.

Call us for literature. Ask for a demonstration.

* All three diagrams reproduced directly from Microplot.

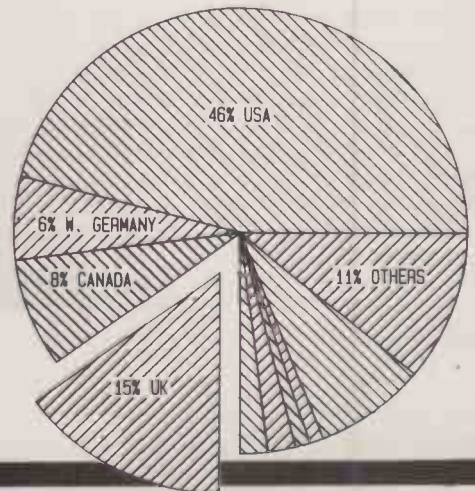

MICROPLOT – A NEW DIMENSION IN VISUAL PRESENTATION – AT ONLY £395 + VAT

KGB
MICROS LIMITED

To KGB Micros Ltd – Please send me full details of Microplot.
 Name: _____ Position: _____
 Company: _____
 Address: _____
 _____ Tel No: _____

14 Windsor Road, Slough, SL1 2EJ. Tel: Slough (0753) 38581/38319. Telex: 847777.

● Circle No. 128

Sinclair goes flat



Peter Laurie takes a look at Sinclair's production line inside the Timex factory.

CLIVE SINCLAIR recently took a small party round the Timex factory in Dundee where Spectrums and ZX-81s are made under contract. We saw, as you might expect, a large number of industrious Scottish ladies making computers against time.

Having originally been in the business of making artillery fuses for the US forces, Timex went over to watchmaking after the Second World War and is now boldly migrating into electronics as the mechanical watch business fades away. On a part of the production line that makes a tiny electronics board for the three-dimensional camera, a couple of ZX-81s are used to drive an automatic circuit tester. If the board fails the test the ZX-81 prints out a diagnosis.

Spectrum tests

Further along the line there is a station where Spectrums are connected to a tape recorder, loaded with a test program and run through a complete set of hardware tests under software control.

A computer is a computer, but a tiny flat TV screen is an interesting gadget. The better half of the day was a tour of the brand-new, highly automated line that will produce Sinclair's long-awaited flat-screen TV tube. This device is about 3in. long, 1in. wide and ½in. deep. It produces a rather squashed picture on its inside that is viewed through the optically flat glass lid.

At first sight you would think that an electron beam fired parallel to the phosphor would produce a hopelessly distorted picture, but it turns out that with correct proportions all the errors cancel out. The most impressive part of the line is a chain of miniature robots which make the gun assembly, some of whose parts are so small you can only watch the operations under a microscope.

Cheapest alternative

Sinclair says that when the line is running properly it will produce 1,000,000 tubes a year per shift. The price will be "considerably lower" than the equivalent conventional tube and still a lot cheaper than any possible LCD or LED display of the same size. Some members of the party doubted this, but Sinclair said that although a high-resolution, pixel-addressable screen might sound more advanced, it needed a vast amount of control logic, and for the foreseeable future the analogue addressed TV tube would be cheaper.

Projected picture

Sinclair Research plans to absorb the whole production of the line in its own products, the first of which would be a pocket TV for less than £50. Later on, the tube will start to appear in computers.

Although there is only one size, a larger picture can be produced, Clive Sinclair said, by projection. Sinclair has

had a revolutionary f1 lens designed to enlarge the image. Although a lens of this performance for your camera would cost £100 or more, the lens for the tube can be much cheaper because the phosphor can be curved to cancel out aberrations in the image. Brightness of the projected image is assured by running the tube at higher voltages: since the picture is seen through the inside of the tube, a heat sink can be applied to the back of the phosphor to stop it melting itself.

The scale of the production line is most impressive, although Timex, a privately owned American company, is a partner in the venture technological initiative on this scale is most unusual in Britain. One can only wish it well.

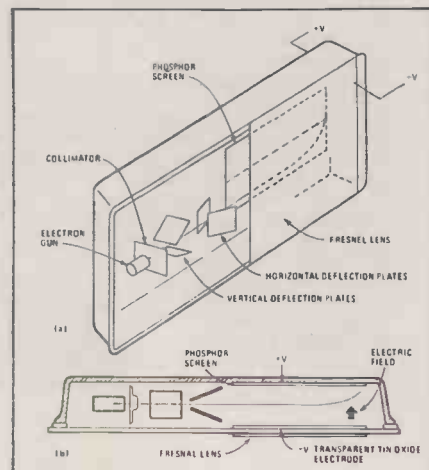

Wherever you are in the UK there's a Genie dealer nearby

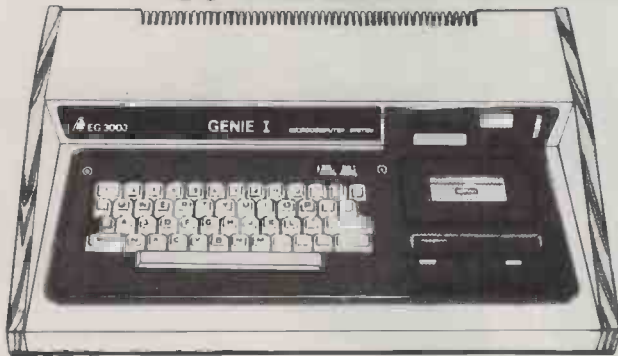

Genie I & II Approved Dealers

AVON Microstyle, Bath, 0225 334659/319705. **BEDFORD** Comserve, Bedford, 0234 216749. **BERKSHIRE** P.C.P., Reading, 0743 589249. Castle Computers (Windsor), 07535 58115. **BIRMINGHAM** Ward Electronics, Birmingham, 021 554 0708. Consultant Electronics, Birmingham, 021 382 7247. A. E. Chapman and Co., Cradeley Heath, 0384 66497/8. **BUCKINGHAMSHIRE** Photo Acoustics, Newport Pagnell, 0908 610625. **CAMBRIDGESHIRE** Cambridge Micro Computers, Cambridge, 0223 314666. **CHESHIRE** Hewart Electronics, Macclesfield, 0625 22030. Mid Shires Computer Centre, Crew, 0270 211086. **CUMBRIA** Kendal Computer Centre, Kendal, 0539 22559. **DORSET** Blandford Computers, Blandford Forum, 0258 53737. Parkstone Electronics, Poole, 0202 746555. **ESSEX** Emprise, Colchester, 0206 865926. **GLOUCESTERSHIRE** **HAMPSHIRE** Fareham Computer Centre, Fareham, Hampshire, Fareham, 231423. **HERTFORDSHIRE** Photo Acoustics, Watford, 0923 40698. Q Tek Systems, Stevenage, 0438 65385. Chrisalid Systems and Software, Berkhamsted, 044 27 74569. **KENT** Swanley Electronics, Swanley, 0322 64851. **LANCASHIRE** Harden Microsystems, Blackpool, 0253 27590. Sound Service, Burnley, 0282 38481. Computercat, Leigh, 0942 605730. BEC Computerworld (Liverpool) 051-708 7100. **LEICESTERSHIRE** Kram Electronics, Leicester, 0533 27556. **LONDON** City Microsystems, EC2, 01 588 7272/4. Wason Microchip, N18, 01 807 1757/2230. Premier Publications, Anerley SE20, 01 659 7131. **NORTH EAST** Briars Computer Services, Middlesborough, 0642 242017. General Northern Microcomputers, Hartlepool, 0783 863871. HCCS Associates, Gateshead, 0632 821924. **NOTTINGHAMSHIRE** Midland Microcomputers, Nottingham, 0602 298281. Mansfield Computers, Mansfield, 0623 31202. East Midland Computer Services, Arnold, 0602 267079. Electronic Servicing Co., Lenton 0602 783938. **NORFOLK** Anglia Computer Centre, Norwich, 0603 29652. Bennetts, Dereham, 0362 2488/9. **OXFORDSHIRE** Micro Business Systems, Whitney, 0993 73145. Pebbleglow Ltd. (Thame) 084421 5368. **SCOTLAND** Esco Computing, Glasgow 041 427 5497. Edinburgh: 031 557 3937. Computer and Chips, St. Andrews, 0334 76206. Scotbyte Computers, Edinburgh, 031 343 1055. Victor Morris and Co., Glasgow, 041 221 8958. **SHROPSHIRE** Tarrant Electronics, Newport 0952 814275. **SOUTH WEST** Diskwise, Plymouth (0752) 267000. West Devon Electronics, Yelverton, 082 285 3434. Bits and Bytes, Barnstaple, 0271 72789. **SUFFOLK** Elgelec Ltd., Ipswich, 0473 711164. **SURREY** Catronics, Wallington, Surrey, 01 669 6700/1. Croydon Computer Centre, Thornton Heath, 01 689 1280. **WALES** Tryfan Computers, Bangor, 0248 52042. **WEST MIDLANDS** Allen TV Services, Stoke on Trent, 0782 616929. **WILTSHIRE** Everyman Computers, Westbury, 0373 823764. B&D Computing (Swindon), 0793 762449. **YORKSHIRE** Media 5 Ltd; Sowerby Bridge 0422 33580. Advance TV Services, Bradford, 0274 585333. Huddersfield Computer Centre, Huddersfield, 0484 20774. Comprite, Bradford, 0274 668890. Superior Systems Ltd., Sheffield, 0742 755005. Photo Electrics, Sheffield, 0742 53865. Ebor Computer Services (York) 0904 791595. **NORTHERN IRELAND** Business Electronic Equipment, Belfast, 0232 46161. Brittain Laboratories, Belfast 0232 28374.



Sole Importers:

LOWE electronics

Chesterfield Road, Matlock, Derbyshire DE4 5LE.
Telephone: 0629 4995. Telex: 377482 Lowlec G.

OEM's This is Your Board

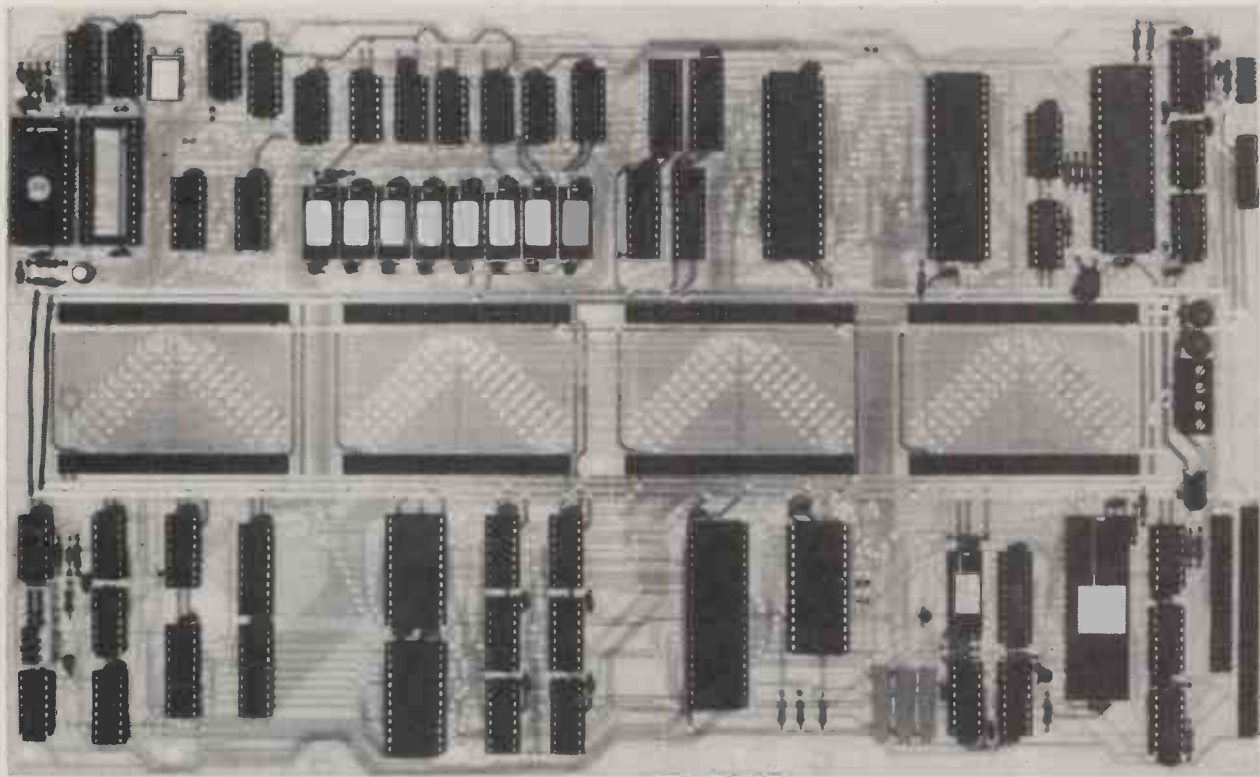

The RADER single board computer has been developed in the U.K. and tailored to offer the user the most up-to-date techniques of microprocessor technology coupled with the built in facilities of ultimate expandability and flexibility.

Based on the popular Z80A Microprocessor running at 4 MHz, up to 16K of internal ROM may be addressed. 2K of video RAM and 2K of character generator RAM is included (both memory mapped). Decoded bank switching permits the addition of as many boards as may be required, each board containing 3 pages of 64K RAM, giving unlimited capacity. A highly flexible memory capability is achievable by the addition of external pages of ROM.

Floppy Disc interface utilises Western Digital's 1797 Disc Controller allowing interfacing to 5¼" or 8" floppy disc drives, side selection for double sided drives and single or double density recording. All data transfers are accomplished by the on-board DMA controller. Other standard features include: On board keyboard port, composite video output and "disc mains" on/off signals; light pen input; inverse video switch to select normal video display background (white on black/black on white); video enhancements switch; plus choice of invert character or dual intensity enhancements.

Monitor with full screen editing facilities plus a full 8 point cursor control. ● Autoboot for business systems ● Autoselect for varying disc densities ● Ability to auto-load extra ROM ● Commands: Dump, boot, edit, input port/output port, break point, go to, copy.

The board is configured to run the latest CPM version 2.2 and ideally suited as the basis for small to medium business machines, games machines, industrial control machines, research and development equipment ● **Board Price £350 plus £4.00 P+P excluding VAT.** (Please state whether 8" or 5¼" board is required.)

Standard features

- 64K RAM
- 4 MHz Z80A CPU
- 5¼" or 8" Disc Interface, single/double/sided density
- Z80A CTC (clock/timer/counter)
- DMA Controller
- Memory Mapped Video Display
- Memory Mapped RAM Character Generator
- Programmable Video Controller
- 8 Expansion Connectors

Configured to run CPM 2.2

- CP/M DOS also includes a utility programme that allows you to format your discs and dynamically configure the systems for a variety of disc and printer types. A set of manuals are also included.

Price £100 plus £3.00 P+P. Send for complete technical specification. All prices excluding VAT.

- Full Custom software development support available

Rade Systems Ltd.,
53-55 Ballards Lane,
London N3 1XP
Telephone 01-349 4711/5
Telex 46523 Simsys G.

RADE
Flexibility at the heart of your system

Add on option boards

- Dual Parallel Ports **£35**
- Dual Serial Ports **£50**
- Cassette Interface **£50**
- RAM Expansion Board, Capacity 192K, in 64K Increments **£250**
- User Prototyping Board **£16.75**
- Real time clock with battery back-up **£45**

All option boards; add **£2.00 P+P**
Prices exclude VAT.

● Circle No. 129

Bill Bennet looks at the latest hand-held micro from Sharp.

SHARP PC-1500

SHARP is the only Japanese name to have captured the imagination of microcomputer buyers in the U.K. The range of machines runs from large business micros supporting CP/M which cost thousands of pounds, through the MZ-80A, B and K, down to a coupe of hand-held microcomputers which look more like calculators.

Yet the PC-1500 is emphatically not a calculator. It is a real microcomputer which happens to be small enough for you to carry in your pocket. True, it does look like a calculator; it has calculator-style keys and an LCD display, albeit turned around along a side of the machine. The right-hand section of the keyboard is just like a conventional calculator keypad, but there is also a QWERTY-type set of keys, a space bar, and an Enter key.

There is also a Shift key, and a set of six keys across the top of the keyboard in the same position as other micros function keys; Sharp calls them "reservable" keys.

To the right of the machine is a power socket which takes the supply from a mains transformer when the machine is being used in an office. The PC-1500 also runs off four 1.5V batteries, which fit in a compartment under the machine, and continual use does not seem to wear them down too fast. The machine is consequently ideal for site work or working at a remote location, and should become a popular tool among engineers and builders.

The review machine came with a CE-151 memory module, a tiny plug-in 4K of RAM which fits into a slot under a cover on the base of the machine. Together with the 2.6K of RAM already available to the user, it provides a useful amount of memory.

The Basic implementation included in the Sharp is fairly standard, though using it is not. Before beginning to program, the machine must be put into the Program mode, and to run any entered program the machine must be put into the Run mode. After using the machine for a short while you become used to this procedure; working in the wrong mode causes an error to be shown, and it can be cleared by hitting the On key, which doubles as Break.

String functions are all supported, as is Print Using, with a number of editing characters. A Beep command enables the tiny speaker in the machine. It has the format:

BEEP a,b,c

where a is the number of times the beep-

ing tone is repeated, b is its frequency and c its duration.

A number of special commands are included to handle the LCD display. For example, Cursor positions the cursor across the display, while GCursor positions the cursor at any one of the 156 dots across the width of the display. GPrint prints a pattern of dots on the display, and Point returns the number which represents the pattern of dots in a column.

The six reservable keys allow the user to recall a frequently typed phrase or keyword. Each one can recall any one of three reserved words, which can be selected by the Reserve Select key.

Powerful printer

The CE-150 printer and cassette interface turn this powerful and portable pocket computer into a useful desk-top tool. At around £150 the extra hardware may seem expensive until you examine the capabilities of the amazing little printer more closely. In reality more like a plotter than a printer it provides a choice of four colours, printed on to tally-roll paper about 1.75 inches wide. The roll sits in a cradle behind the printing ironmongery, while the colours are provided by four different ball-point pens. Nominally black, blue, green and red, they may be exchanged or substituted by other colours as the computer does not know which is which.

The printer is more like a plotter, with a choice of four colours.

The four pens sit in a carousel which rotates on power-up to put the colour 0 — normally black — in position. Other colours can be invoked by the Colour command. The functioning of the printer, in particular the changing of pen colours, can be tested by using the Test command, which draws four boxes, each of a different colour across the width of the paper. It really is quite fascinating to watch this happening when the lid is taken off the printer: before the carousel is rotated it is returned to the extreme left position, as it does every time the pen colour is changed.

The PC-1500 incorporates a sophisticated error-detection facility which extends to the printer. Sometimes, on

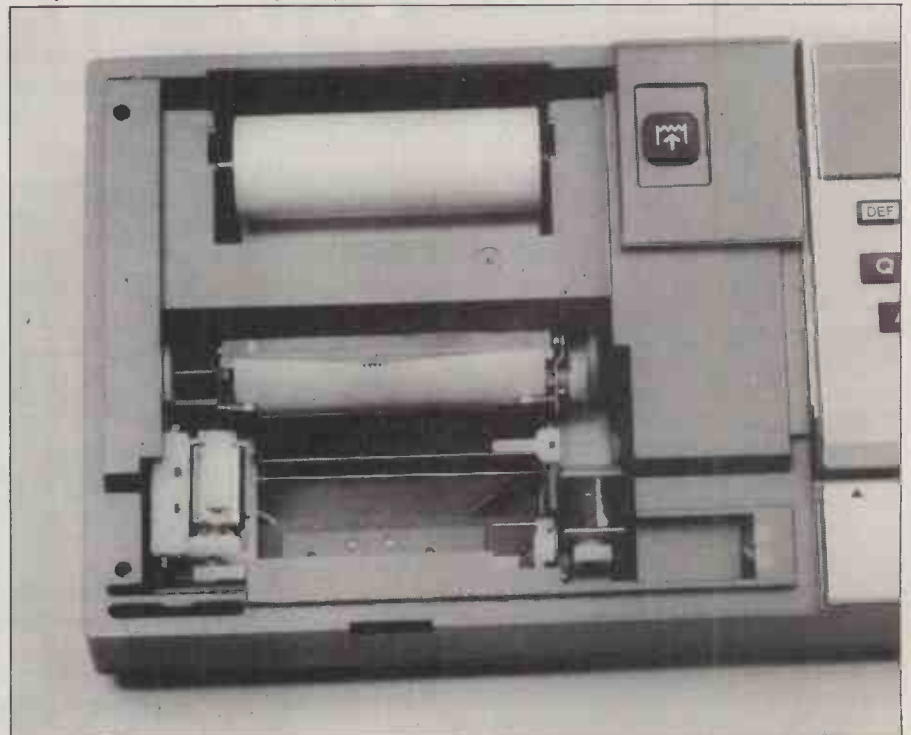

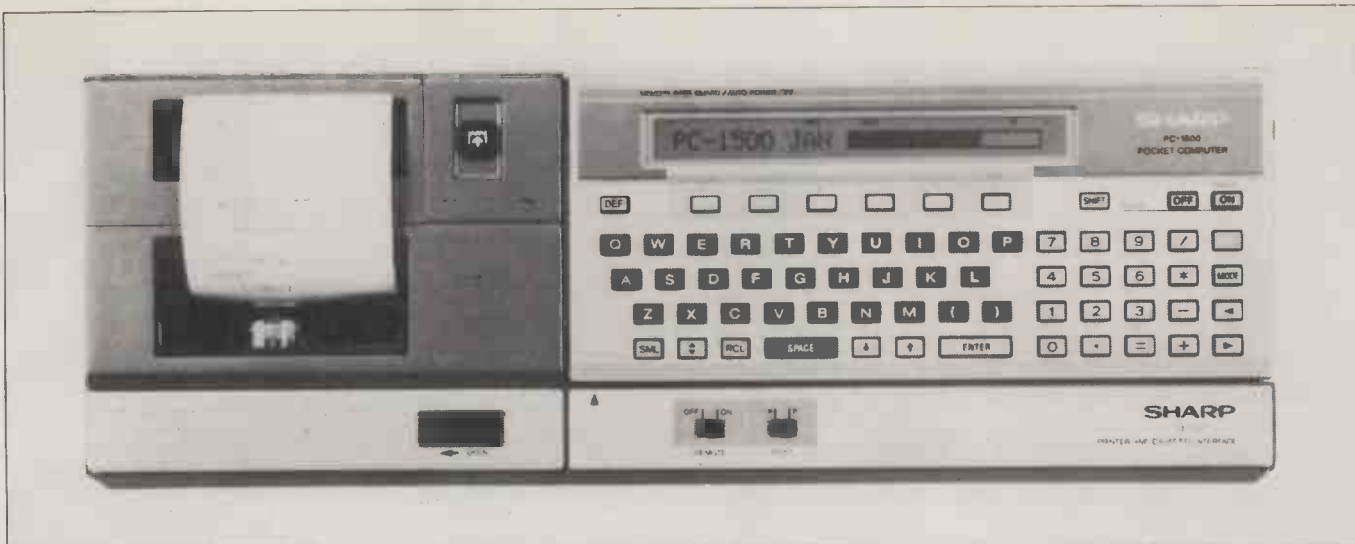

power-up the message "Check 6" appears, indicating a fault in the printer. If the pens are not in the correct rotational position the paper and carousel move about but no actual printing takes place.

The printer has a button for winding on the paper, which can also be done under software control. Vertical or diagonal lines are drawn by moving the paper itself. They can be up to about four inches in both the positive (up the paper) and negative (down the paper) directions. If there is not enough paper then what there is will rewind completely, though sometimes this means you have to re-feed the paper into the slot at the rear of the printer.

As an alternative to the low-resolution character-printing mode a high-resolution mode can be invoked by the Graphic command. In the character-printing mode there is a choice of print size — see table 2. The very large sizes are awkward to use but may be needed for printing tickets, labels and so on. The printing can be turned around on its side using the Rotate command. The argument of the Rotate expression is a number in the range 0 to 3 to choose any of the four possible orientations — see figure 1.

In the normal or character mode the paper can be wound back and forth with the line-feed command LF. As with the line command, the maximum distance of travel is about four inches. LPrint works just as LPrint on other micros the world over. An error message is given when CSize is too large for the whole of a number to be printed on a line.

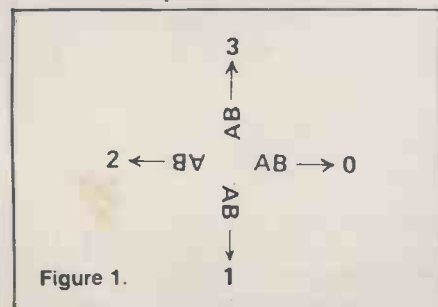

Figure 1.

LCursor positions the pen on the paper in a similar way to a command Cursor, which positions the cursor across the LCD display. Tab works from within a LPrint statement to do the same thing.

In the graphic mode the pen may be moved around the paper without printing anything. The GLCursor statement moves the pen to the x,y coordinate specified in brackets after the command. As with all other commands in the high-resolution mode the limits of x and y are -2047 to 2047.

Line commands

To establish the origin the command SOrgn is used. This sets the point at which the pen is currently located as the origin of the x,y coordinate system. The Line command is very flexible and may be used to draw 10 different types of line as shown in table 1. Line 9, that is pen-up, is an alternative to GLCursor. The Line command has the format:

LINE(X1,Y1)-(X2,Y2), line-type, colour, B
The bracketed coordinates after the command are the coordinates which have a line drawn between them. Normally there will be two of them, though more may be required in some cases. It is possible to have a list of up to six such pairs, making it possible for the user to define a personalised character set. For example, the listing:

```
10: GRAPH
20: LINE (0,0) - (0,10) - (5,15) - (10,10) -
(10,0): LINE (0,5) - (5,5) - (5,6) - (10,6)
produces an "A" with a staggered crossbar. Programmers do not normally have to go to these extremes, as there is a full character set complete with lower-case letters and a range of symbols.
```

The capital B at the end of the line command indicates that a box is to be drawn. The computer assumes that the first coordinate pair is one corner of the box and that the second coordinate pair gives the diagonally opposite corner. RLine is similar in concept to Line except that it draws a line relative to the current pen position.

Line-type Value	Resulting Line Size
0	Solid Line
1	0.4 mm dash
2	0.6 mm dash
3	0.8 mm dash
4	1.0 mm dash
5	1.2 mm dash
6	1.4 mm dash
7	1.6 mm dash
8	1.8 mm dash
9	Pen Up (no line)

Table 1.

Specifications

Operating system and monitor: in 16K ROM
 Languages: Basic
 Memory: 3.5K RAM, user area 2.6K; plug-in 4K available
 Keyboard: 65 keys including user-definable function keys
 Power: 6V dc power supply, or will run for 50 hours on dry batteries
 Dimensions: 195 x 86 x 25.5mm
 Weight: 375g
 Display: 26-character liquid-crystal display, 7 x 156 dot graphics

It is possible to print out the results of any calculation performed by the computer in the immediate mode by moving the print switch, located on the interface beneath the computer, to the P position.

All-in-all the capabilities of the CE-150 printer are very good. It is a shame that the printer cannot be connected easily to other computers as many would be greatly enhanced by it.

Loading and Saving cassettes on the Sharp is not the hit-and-miss business it can be on other machines. The CE-150 interface unit provides a solid base on which the cassette operating system works.

Apart from the standard cassette facilities, the PC-150 will verify a program, merge programs and Chain them. Data can be Saved and recalled to and from

(continued on next page)

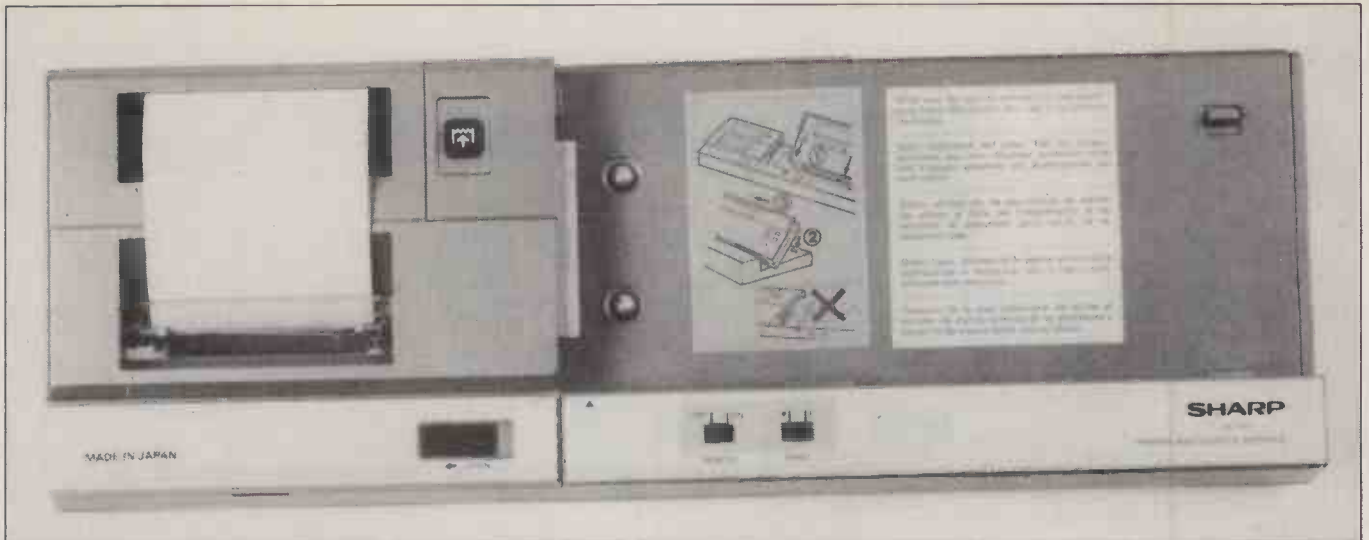

The pocket computer slots easily into the printer and cassette interface.

(continued from previous page)

tape as well. The applications tape provided by Sharp contains 14 programs for the computer which all loaded easily and appeared to work, though there were no instructions with the programs. The programs in the applications manual did include instructions, and the file names of the programs on the tape coincided exactly with those omitted from the applications manual.

Software supplied

The applications manual itself includes a wealth of material. The listings are presented in a clear and useful way, and the fundamental theory behind the programs is also shown, together with instructions on using them. Among the supplied programs are several devoted to the numerical chores that scientists and engineers could spend hours working out with slide rules and reams of paper. They include root-finding, matrix-processing and Fourier series. There are also correlation, linear regression and similar statistical routines, as well as programs to calculate loans and interest payments, graph-plotting routines, inventory control, purchase ledger, biorhythms and many others including some games.

Conclusions

- The Sharp PC-1500 encapsulates an incredible amount of computing power in the smallest possible package.
- It is an ideal tool for people in the building, engineering or scientific professions to use "on-site". Business users may like find the Sharp useful as a super pocket calculator.
- Battery power means true hand-held computing.
- The CE-150 printer and cassette interface turn the super pocket calculator into a really useful and relatively sophisticated computer.
- The CE-150's printing capability is excellent, real high-resolution graphics in four colours.

Table 2.

CSIZE	1	2	3	4	5	6	7	8	9
Characters per printed line.	36	18	12	9	7	6	5	4	4
Height of each character (mm)	1.2	2.4	3.6	4.8	6.0	7.2	8.4	9.6	10.8
Width of each character (mm)	0.8	1.6	2.4	3.2	4.0	4.8	5.6	6.4	7.2

Table 3. ASCII character code chart for the PC-1500.

		Upper Bit Positions → b7, b6, b5							
		000	001	010	011	100	101	110	111
Low Bit Positions b4, b3, b2, b1	Hexa decimal	0	1	2	3	4	5	6	7
	↓	0000	0		SPACE	0	@	P	
	0001	1		!	1	A	Q	a	q
	0010	2		"	2	B	R	b	r
	0011	3		#	3	C	S	c	s
	0100	4		\$	4	D	T	d	t
	0101	5		%	5	E	U	e	u
	0110	6		&	6	F	V	f	v
	0111	7		[7	G	W	g	w
	1000	8		(8	H	X	h	x
	1001	9)	9	I	Y	i	y
	1010	A		*	:	J	Z	j	z
	1011	B		+	:	K	√	k	{
	1100	C		,	<	L	¥	l	;
	1101	D		-	=	M	π	m	}
	1110	E		.	>	N	^	n	~
	1111	F		/	?	O	-	o	■



One Expander Card for apple leads to another....

In fact it leads to many others! Joining the amazing success of our PAL Encoder Card, these four new expander cards all featuring the unique 'Digitek Safety Tab' are ready to plug straight into your Apple Computer.

PAL Colour Encoder Card £105 This amazing card with it's on-board modulator, displays exceptional colour graphics to your TV.

16k Ramcard £91 Insert the card straight into slot 0, and increase the memory capability of your Apple without having to remove any memory chips.

Z80 Expansion Card £110 Installing the Z80 into your Apple gives you two systems in one, which enables you to run the popular C/P/M operating system.

RS232 High Speed Serial Interface £72 The RS232 Interface Card incorporates 13 selectable Baud rates from 75 to 19,200.

Print-master Interface £79 The ultimate parallel interface for Apple to all popular dot matrix printers.

The PRINT-MASTER accepts Apple protocols, 15+ software commands and has on-board graphics dump capability to all popular graphics printers. No need to load clumsy software routines - it's all at your fingertips on the PRINT-MASTER - choice of inverse printing, double size picture, 90° picture rotation, many word processor type text commands, plus many more.

Apple is the trademark of Apple Computers Inc. Digitek and Print-master are the trademarks of Digitek (International) Ltd.



Dealer enquiries welcome

The people who are really into Apples.

DIGITEK

● Circle No. 130

EXPANDER CARD SERIES

Please send me
Colour Encoder £105
Ramcard £91 Z80 £110
RS232 £72 Print-master £79
Further Information

I enclose my cheque for £
payable to Digitek International Ltd.
Add 15% VAT to all prices quoted.
Post and packaging FREE.
Telephone orders **0403 66550**

Name.....
Address.....
Post Code

My card:.....
Number is

DIGITEK (INTERNATIONAL) LTD. 37C WEST STREET, HORSHAM, WEST SUSSEX RH12 1PP.



PC8

Great minds think alike.

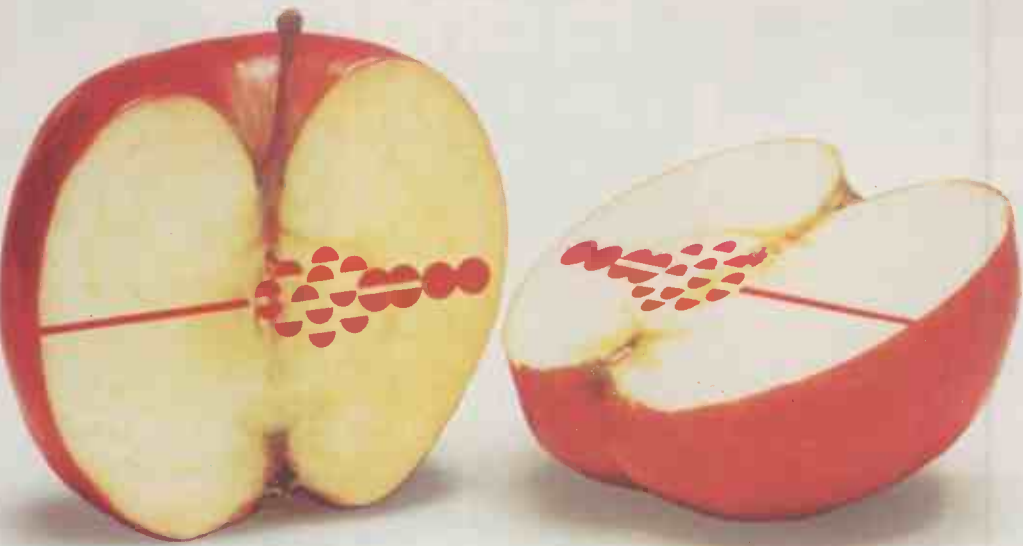

Look inside the top microcomputers on the market and you will find the best business brains in the country. Ours. Because the key to the efficient use of the microcomputer in your business is high quality 'software' — a set of programs which direct and instruct the computers operation. A microcomputer without software is like a car without a driver! And as one of the foremost software organisations in the industry we're amongst the enterprising few whose software packages are compatible with most leading manufacturers models — including the Apple II & III Xerox 820, Phillips P2000, IBM Personal Computer and NEC PC-8000.

It means that whichever of these microcomputers you own, or contemplate purchasing, you have access to the most advanced range of business software currently available — as well as one of the most widely distributed and preferred.

On the financial front for example, there is a definite meeting of minds over the superiority of our software to perform your ledger accounting, payroll, invoicing, cashflow, planning, budgeting and stock control. Word processing, addressing and mailing, job costing and more will be available in the near future.



In the last year alone over 500 companies have invested in our Financial Controller suite of programs and over 2000 packages have been sold in the UK alone — which together with a full complement of Systematics International software is now available at around £250 per package from Currys Micro-C, Beams Business Centres, The Xerox Stores and over 100 of the best microcomputer centres throughout the UK.

Needless to say, the technical excellence of our software is matched by its high commercial quality. All software is supported by comprehensive easy to follow manuals that take you through organising, setting up and using your microcomputer business system — from an International Company with over 10 years experience and hundreds of satisfied customers worldwide. All can be complemented by management and staff training facilities at our computer and business study centre in Suffolk.

UNDERSTANDING MICROCOMPUTERS— a video tape

To help you decide whether a microcomputer could help you better manage and control your business, Systematics International have prepared a video tape to put you in the picture!

It shows, the elements of a microcomputer business system, how it can help, how to choose, the benefits to be gained and the pitfalls to avoid.

At only £39.95 plus VAT and carriage, it could save you from making an expensive mistake. And considering the business potential of the right microcomputer it's also a small price to pay for success.

So if you really want to get to grips with your business, pick our brains. Everybody else does!



Systematics International Microsystems Limited



Cleves House, Hamlet Road, Haverhill, Suffolk Tel (0440) 61121 (24hrs) Telex 99431 SIG
Simply the best business software for your microcomputer

List of Dealers contributing to this advertisement.

ENGLAND Avon Beam Business Centre 0272 742291 Currys Micro-C (at Bridgers) 0272 650501 T&V Johnson 0272 422061 Bedfordshire Currys Micro-C 0582 425079 Berkshire Lynx Computers Ltd 07535 56322 Cambridgeshire Sydney Both 0223 207239 Cheshire Fairhurst Instruments 0625 525694 Co. Durham Knowledge Ltd. 0385 354782 Cumbria Lakeland Computer Services 09667 240 Devon Diskwise Ltd 0752 267000 Essex Godfrey Computer Centre 0268 206550 Hunt, Smees & Co. 0268 21245 Ramnor Computing Ltd. 0702 339262 Gloucestershire Beam Business Centre 0242 582368 Gt. Manchester Beam Business Centre 061 831 7066 Currys Micro-C 061 834 0144 Hampshire Currys Micro-C 0703 29676 Herefordshire Local Business Technology Ltd. 099 24 66157 Humberside Access Computer Services 070 685 2326 Kent Prince Mobile 0732 845640 Lancashire DMS Ltd. 0254 28419 L&P Business Systems 0282 50252 Professional Data Systems 0204 493816 Leicestershire Currys Micro-C 0533 546224 Lincolnshire Estate Computer Systems 0529 305637 London Beam Business Centre 01-380 0388 CWP Computers 01-828 3127 Currys Micro-C 01-387 9275 Electronic Office Services 01-236 9065 Eurocourse 01-739 8092 Group 18 Ltd. 01-802 7186 Guestel 01-583 2255 Planning Consultancy Services 01-839 3143 Middlesex Granada Computer Systems 01-843 1971 Norfolk Anglia Computer Centre 0603 29652 Northamptonshire Neath Hill Professional Workshop 0908 660364 Nottinghamshire Currys Micro-C 0602 412455 Oxfordshire Johnson Microcomputers 0865 721461 Warwickshire 04912 77926 Roccon Ltd. 0235 24226 Somerset Taunton Electronics 0532 45815 Suffolk Systematics International 0440 61121 Surrey Ferguson Computer Services 09323 45330 Johnson Microcomputers 0276 20446 Microlines Computers Ltd. 01-546 9944 Rothwell Computer Services 0252 510441 Vega Computers Ltd. 01-680 4484 Sussex Dataitech 0323 36266 Southern Microcomputers Ltd. 07942 3443 Tyne & Wear Micro Computing Ltd. 0632 476018 Warwickshire Impulse Micro Systems 0789 295819/297263 West Midlands Beam Business Centre 021 429 4631 Currys Micro-C 021 233 1105 Worcestershire Centip Star Microcomputers Ltd. 0562 66201 Yorkshire Currys Micro-C 0532 446501 Wharfedale Business Systems 0226 758021 SCOTLAND Beam Business Centre (Edinburgh) 031 225 3752 Beam Business Centre (Aberdeen) 0224 56161 WALES David Potter Office Equipment Ltd. 0222 496785 Spartamay Ltd. 06333 72360 IRISH REPUBLIC Softech Ltd. 0001 720280 CHANNEL ISLANDS Guernsey Computers 0481 28738

SI software is also available from over 400 additional microcomputer centres in the U.K. and Internationally in Chicago, Frankfurt, Johannesburg, Melbourne, San Francisco, Singapore, Stockholm, Tokyo

More information on the best Microcomputer Business Software available and the name and address of my nearest stockist.
 Your video • Understanding Micro Computers.
I enclose cheque no. _____
Name _____
Address _____
• VHS Betamax (allow 28 days for delivery) (P.C.)

ZENITH

data systems



WHETHER YOU'RE A DEALER OR OEM—

Zenith can offer a product capability that includes:

- Microcomputers, CP/M based with storage to 10 Megabytes
- Systems that start from £1795*
- Word processing, including letter quality printer from £2985* (or lease from only £14 per week)
- A comprehensive range of Printers, VDU's, systems and applications software
- 12" green screen Monitor— in Apple colours. (Dealer/OEM's only)

Equally important Zenith is a company that:

- Is supported by the multi million dollar Zenith Radio Corporation of America
- Is committed to holding comprehensive UK stock
- Offers Country-wide service support
- Offers Dealer support including National Advertising Campaign
- Offers Realistic Discount Structures

*Prices correct at time of going to press.



NEW DEALER ENQUIRIES WELCOME

PC/'82

I could be interested in a Dealership I would like to receive details of your OEM terms

Name _____ Position _____

Company _____ Address _____

Telephone _____

ZENITH data systems

The quality goes in before the name goes on.

Or call Dave Taylor or Jim Detheridge at:-
Zenith Data Systems Bristol Road, Gloucester. GL2 6EE. Telephone 0452 29451.

● Circle No. 132

TELEVIDEO 802

Chris Bidmead tries out a newcomer to the band of microcomputers offering a built-in hard disc.



THE NAME Televideo has been associated with clever video terminals capable of such party tricks as local text editing and field protection. Most spectacular of all is the facility for smooth scrolling, where the text moves up in front of your eyes like paper being rolled out of a typewriter.

A Televideo 950 terminal has already passed through this office in conjunction with the MicroPro PBM-1000 CP/M computer, reviewed in *Practical Computing*, May 1982. A thickish manual was supplied to explain its intriguing display facilities, but our exploration of the PBM's extended memory management left us little time for the terminal.

Now, with some physical horizontal stretching to make way for disc drives, 64K of internal RAM and a processor board, the Televideo has reappeared on our desk as a stand-alone CP/M-based micro. Options are available for dual floppies, hard discs or a multi-user quasi-network linked together through the new RS-422 standard serial asynchronous protocol.

The review machine was the 802H, equipped with a single Tandon mini-floppy drive, and a Seagate hard disc. The Stat DSK: listing in figure 1 shows the unusual backing store configuration: it is not uncommon for the physical hard disc to be divided up into two notional drives, but the Televideo Seagate is configured to provide a third drive, drive C, of 342K capacity that emulates the floppy.

Precisely why this should be, the manual does not say, but then there is quite a lot about this sophisticated hardware that the documentation passes over in silence. The intention may be that back-up files should be assembled on drive C with Pip, the normal CP/M Peripheral Interchange Program, in preparation for bulk transfer to the floppy with a sector-to-sector transfer program, but no such software is provided among the utilities.

In fact the Televideo 802H is the first hard-disc machine we have reviewed which offers no software provision for hard-disc back-up beyond Pip. With no means of splitting files retrievably between floppies, Pip cannot cope with the

sort of large database files that a hard-disc machine uses. A serious omission, this, in a computer that must be at least partially destined for business use, though Chan Idnani of the London Computer Centre — who kindly supplied us with the machine — said he thought there was a Backup program on the way.

What unquestionably makes the Televideo 802H worthwhile is the hardware. The cabinet, without keyboard, but allowing for protruding plugs at the rear, takes up a desk space of about 40cm. deep by 57cm. wide, and stands under 30cm. high. The well-contoured edges of case and keyboard suggest that thoughtful design effort has been brought to bear on the product's cosmetics, without the flaunted shape-making of some recent micros.

The green, glare-resistant screen presents the most stable image we have yet seen on a serial terminal designed for U.S. voltages, and shows no sign of "transatlantic swim". The character set might usefully be larger, but the ascenders and descenders are well pro-

portioned. Descending characters like lower-case "p" and "g" have their upper portion very slightly lifted from the baseline, but the effect is legible and pleasing, adding an almost hand-written quality. Pascal and C programmers will be glad to know that curly, square and round brackets are well differentiated.

The excellence of the screen was initially spoiled by the fact that at normal desk height it tends, rather unhelpfully, to face the user square in the chest. We remembered from the PBM review that the terminal version has an extendable foot centrally placed under the screen to tilt it upwards. After some experiment to compensate for its absence on the 802H we found a judiciously placed paperback greatly improved the system's ergonomics. It was not until much later, when we entered the dismantling phase of our investigation, that we discovered a pair of discreetly hidden broad-headed screw shanks left and right of the undercarriage, clearly intended to serve just this purpose. A minor criticism of the arrangement — apart from the fact that it was well concealed and quite undocumented — was that without a stop at the end of the thread these came adrift from the case when screwed past their maximum adjustment.

As with the Televideo 9xx series of terminals, the bottom row of the screen displays an inverted video status line

Figure 1.

A: drive characteristics	
27904:	128byte record capacity
3488:	kilobyte drive capacity
512:	32byte directory entries
0:	checked directory entries
256:	records/extent
32:	records/block
64:	sectors/track
2:	reserved tracks
B: drive characteristics	
27904:	128byte record capacity
3488:	kilobyte drive capacity
512:	32byte directory entries
0:	checked directory entries
256:	records/extent
32:	records/block
64:	sectors/track
438:	reserved tracks
C: drive characteristics	
2736:	128byte record capacity
342:	kilobyte drive capacity
64:	32byte directory entries
0:	checked directory entries
128:	records/extent
16:	records/block
64:	sectors/track
875:	reserved tracks
D: drive characteristics	
2736:	128byte record capacity
342:	kilobyte drive capacity
64:	32byte directory entries
64:	checked directory entries
128:	records/extent
16:	records/block
72:	sectors/track
2:	reserved tracks

which on the left-hand side shows the cursor co-ordinates. The data that follows further along the status line is more useful, and is worth noting in the early stages of coming to grips with the hardware. Four sections display the current terminal modes that define the complex relationships the terminal is able to enter into with the internal serial line to computer. This can be confusing to both the user and the computer unless the point is well understood that the computer and the terminal, though cased together, are entirely separate logical entities.

The manual devotes about 40 of its 100-odd pages to describing the refinements of the terminal, and the section seems to be a lightly edited version of the standard Televideo terminal-only manual. The depth of detail in which it describes the display possibilities contrasts with the elementary approach adopted elsewhere in the manual: "The lighted rectangular block which appears on the screen indicates the entry spot for the following character to be typed. It is called a cursor..."

Default to Local

The manual seems uncertain about its level of explanation, but does include some clear drawings of plugging in cables and handling diskettes. Sometimes the clarity of the simpler sections ignores the complexity of the hardware: "If you make an error while typing, simply press the Backspace key and the cursor will move to the left..."

Well, yes, on any ordinary computer it might. But one essential point buried rather too deeply in the manual is the terminal's distinction between Duplex and Local, displayed on the status line as Dupe and Loce. Unless expressly switched into Duplex mode — oddly, the default on power-up is Local — keys like Tab and Backspace will not pass their code down the line to the computer. One disconcerting result of this is that in WordStar the cursor keys can appear to move the cursor across the text, but the new location will be unknown to the program. This apart, WordStar works extremely well on the 802H, with the speed of the hard disc, the Direct Memory Access chip and the processor going a long way to disguise the overlays and heavy computational overhead of a word-processing package that often seems sluggish on floppy-based machines.

The confusion the cursor keys create is not destructive, and WordStar will pick up and carry on where it left off when it next receives a cursor instruction it understands. The seasoned programmer, used to the idiosyncrasies of keyboards, might well find the nuisance trivial. The fix, if anyone bothers to make it, is a breeze: patching WordStar to send ESC '1' as part of the initialisation string will turn on Duplex mode automatically.

The keyboard arrives set up to give an insistent "beep" with every keystroke, but there is a very welcome DIL switch to the rear of the machine to disable it. The keyboard connects to the mainframe by way of a coiled cable, and plugs in with an American miniature telephone jack. Following the puzzling convention adopted by other manufacturers, the keyboard cable enters the terminal at the rear, as if designed to be used by a typist working blind behind the computer while a colleague watches the screen from the front.

The central QWERTY cluster of the key layout is IBM-like, with one or two disconcerting differences. For example, a typist would expect the shift lock to unlatch when the shift is pressed, but the ordinary shift lock is missing from the keyboard. The key in its place, above the shift, is the alpha lock, which works as a straight toggle and gives access only to the upper-case letters, leaving the punctuation keys in their lower-case mode. There is no LED on the alpha lock to show when it is engaged.

The main character keys and the numeral pad keys on the right of the keyboard are in dark grey, a lighter grey being used to differentiate the line of 11 function keys that runs along the top. Both the upper and lower case of these keys are available for programming with preset code, either from the keyboard or from the computer. Instant keyboard programming turned out to be useful for frequently repeated commands: a kind of Submit facility built into the keyboard. Because the function keys are programmable from the computer, the more often used WordStar commands can be downloaded at the beginning of a session.

Working blind

There are 19 bolts on the underside of the case, some of which hold down the cover, the rest being structural. We proceeded cautiously, remembering the explorations of our youth into costly devices whose cases stayed clam-tight, rattling the while with more and more loose components as each wrong bolt is unscrewed. We found a sketch in the appendix to the user's manual that showed the four bolts to be removed, but from that point on our invasive surgery had to be made without further documentation: the hardware manual promised by Midletron failed to arrive in time.

In fact you have to remove five bolts to free the top of the case. Inside is a rigid frame consisting of two sub-assemblies bolted together. On the left — viewed from behind — is the terminal chassis with the main computer electronics mounted horizontally beneath the neck of the CRT. Below that, well-shielded behind a metal plate and a heavy cage, is the power unit.

The mounting for the two disc drives is
(continued on next page)

(continued from previous page)

on the right-hand side: a sort of apartment-house shell with the floppy in the penthouse and the Seagate relegated to the basement, and ample room between them for one more mini-drive unit. Televideo's own hard-disc controller board is mounted vertically outside this chassis.

An unlabelled PCB, presumably the floppy-disc controller, is piggy-backed on to the main computer board, a "big-board" unit mounted horizontally some way beneath the neck of the CRT. With a little judicious wiggling to free descending protrusions that snag against the bottom of the case, this can be slid out like a drawer once four jumper blocks have been unhitched.

The operation flexed the board, something best avoided under normal circumstances but quite a good test of the soundness of the internal connections. No dry joints showed up in the process, confirming our visual impression that the construction was generally sound. The main big board may well be Japanese: the name Seiko appears on the underside.

Auxiliary chips

With this kind of accessibility a service engineer could swap the board over in about a quarter of an hour. We did not time the exercise, pausing instead to cast an eye over the selection of chips. It was gratifying to find a pair of Zilog SIOs taking care of the serial interfaces, a Zilog clock timer counter and a direct memory-access chip second-sourced from Sharp. These are high-priced components as eight-bit chips go, but can take much of the load off the Z-80 to speed up serial data transfer and disc accesses.

We found further evidence of state-of-the-art eight-bit electronics. The familiar four-by-eight array of 16K memory chips is replaced on the 802H main board by a thin gold line of eight Fujitsu MB8264-20 64K chips, nestling under the piggy-backed floppy-disc controller board. The video drive unit is positioned vertically on the left-hand side — again, looking from the rear. The preset focus, linearity, height and brightness controls are easily accessible, although only the contrast knob can be adjusted once the case has been replaced.

Visible from the rear with the cover off are four diagnostic LEDs on the big board which light up in sequence during power-up and are all steadily illuminated once the system has been correctly booted. Without a hardware manual it was impossible to know what precisely they were trying to tell us.

The standard OEM Seagate drive unit is designed so that its front panel can be mounted flush with the exterior of whatever casing it finds itself in, exposing to the outside world a reassuring little LED that a well-tuned Bios can flash to indicate the drive is being accessed. A similar

arrangement is standard with floppies, but with hard discs it is even more useful. Unless you have a sharp ear it is impossible to tell whether the drive heads are responding. By burying the Seagate internally, the Televideo 802H loses this occasionally useful feature.

The memory appears to be used conventionally, except that it gives the system designer and the manual writer another opportunity to squabble. According to the manual, the power-up message is supposed to read

59K CP/M vers 2.2

In reality it says

64K CP/M vers 2.2

which seems to indicate that an arrangement has been made for the ROM bootstrap software, and something called "4K of diagnostic ROM" to be phantomed out once it has done its work. That is to say the address lines are switched automatically and the ROM is effectively replaced by a similar-sized block of RAM. Hardware documentation would have been very helpful in verifying this.

One of the set-up DIL switches on the rear enables the machine to boot either from the floppy or from the hard disc. This option is usually offered on a hard disc computer as a way of installing the operating system. Normally when booting from the floppy, which would then be seen as drive A, the hard disc is available as a secondary drive, or as a pair of secondary drives.

Idiosyncrasies

The Televideo implementation is eccentric, to say the least. Booting up on the floppy offers only two drives, A and B. Neither of these drives is the hard disc, which appears to be completely inaccessible to ordinary file operations, and both drives represent the same double surface of the floppy.

On setting the DIL switch to the Hard Disc Boot position the disc assignments revert to the configuration in figure 1. Curiously the bootstrap software still insists on going to the floppy drive first and giving it a whirl even if there is no disc in it. This behaviour added to our feeling that the software has too many rough edges and lags behind the sophisticated hardware, though it probably only needs a simple software fix.

Like the rest of the software tailoring, it should really be stitched in before terminal and internal computer are pulling together as a coherent CP/M machine; without it, the user is in danger of perceiving the kit as complicated and idiosyncratic. Together with a decent suite of utilities and fuller documentation, this is what is missing before the equipment begins to do justice to its capability as a system.

Only three utilities are provided: one each to format the hard and floppy disc, and a third that mops up bad sectors on

the hard disc as necessary and tidies them away in a file called File.Bad.

A system should offer more than this. Televideo goes part of the way by including a complete listing of its Bios, that section of the operating system that has to be tailored by the manufacturer to link CP/M's standard package to the hardware. Though it may not mean much to many users, we found it an essential antidote to the manual, which flatly contradicts it in many places.

The output section of Bios has been written to provide two distinct ways to prevent buffer overflow at the printer attached to the serial port. Software hand-shaking — the exchange of control codes along the ordinary transmit/receive lines between computer and terminal — can be selected to match the protocol preferred by any particular printer. Modem flow control, which calls for additional lines that are toggled high and low to start and stop the movement of data, can be selected similarly.

So far so good. This sort of flexibility is what microcomputers are all about. But instead of a simple routine called, say, Set.Com to establish which kind of handling comes into use on power-up, the manual invites the user to participate in an unwelcome mystery tour of programmer's delights like Sysgen, Save and DDT, bearding the IObyte in its lair at address 0003. Putting aside the fact that this section of the documentation mistakenly transposes the printer module names in the opening paragraph, and contains two numerical errors in the quoted examples, the point is that a properly constituted system should not expose the user to this kind of excitement when all he or she wants to do is drive a Ricoh from CalcStar.

Certainly a lot of other so-called "systems" are still being launched upon the world in similar nakedness, swelling the murmur of discontent against CP/M. This is really rather unfair: CP/M's facilities are more or less limitlessly extendable through the addition of purpose-written .Com files. Yet for the most part dealers, importers and manufacturers have failed to settle among themselves whose responsibility the software effort should be.

Conclusions

- The Televideo 802H is a good-looking, fast, hard-disc, stand-alone computer, with plenty of hardware talent.
- The machine runs under CP/M, and is well behaved once you set the right parameters.
- The documentation is excellent in parts, but its level fluctuates between the obvious and the obscure. Important points are buried or omitted, and there are seriously misleading errors.
- The price of £4,400 makes it good value for money, but the raw state of the software will certainly mean you will have to pay more to do anything useful. □

NEW!

Fast CP/M Business Application Software from Padmede

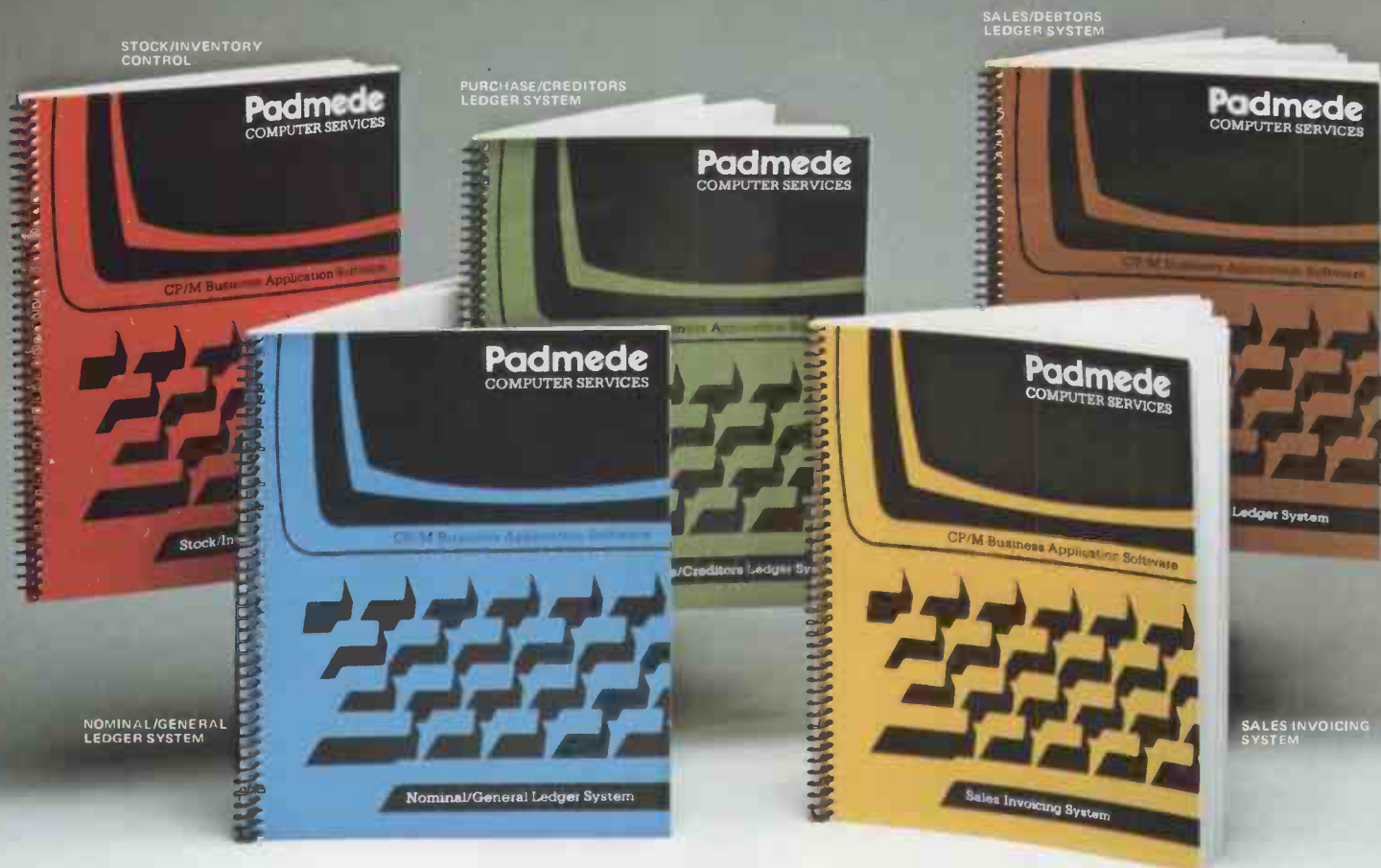

at £249 per module

The Padmede Business Control System is available now
on the following machines:-

- Sharp PC-3201, MZ-80B • Apple II • NEC PC-8000 • DEK VT180 • Sirius I • Osborne I
- ICL Personal Computer • Rair Black Box • Wangwriter
- Hewlett-Packard 125 • OKI if-800 • Toshiba T200 • IBM Displaywriter

Send for details of the Dealer Demonstration Pack

Padmede
COMPUTER SERVICES

351, Fleet Road, Fleet, Hants. Telephone: Fleet (02514) 21892/3. Telex: 858575.

● Circle No. 133

THE DESK TOP GENIUS.

Now from Sharp, the Sharp MZ 80A. A personal computer that is ready to run the moment you own it. Because the CRT display, the typewriter-style keyboard and the cassette-based data storage are all integrated into one complete system that leads the operator, either amateur or professional, into an incredible new computer world.

For this computer has the power to do virtually anything within the range of Personal Computers. In it, Sharp has combined



*MZ 80FB
Twin Mini Floppy Disc Unit.*

*MZ 80P6
Character Graphic Printer.
Also available MZ 80P4 and MZ 80P5*

all its fine electronic technology in the field of information engineering to create a marvel of precision. Plus, when you purchase you get a valuable software package absolutely free.

The superb Sharp MZ 80A. Among its competitors, it is rated as a genius. To you, it will become a desk-top companion you will treasure, an invaluable part of your daily life.



Bringing to your school, office or home, the high-speed skills and advanced technology of the world of Sharp. Where great ideas come to life.

Specifications MZ 80A

CPU	Z 80
Memory	4K-byte ROM; 48K-byte RAM; + 2K-byte Video RAM.
Display	9 inch (23 cm); 40 characters x 25 lines. Green screen.
Cassette	Manual control; standard audio cassette tape. Data transfer (Sharp PWM system) 1,200 bits/sec.
Keyboard	ASC11 keyboard; upper-/lower-case alphabet; graphic symbols; numeric keypad.
Other features	Built-in clock and music function. Auto repeat on all keys. 2-page video RAM (allows the screen to be scrolled up and down). *CP/M available.

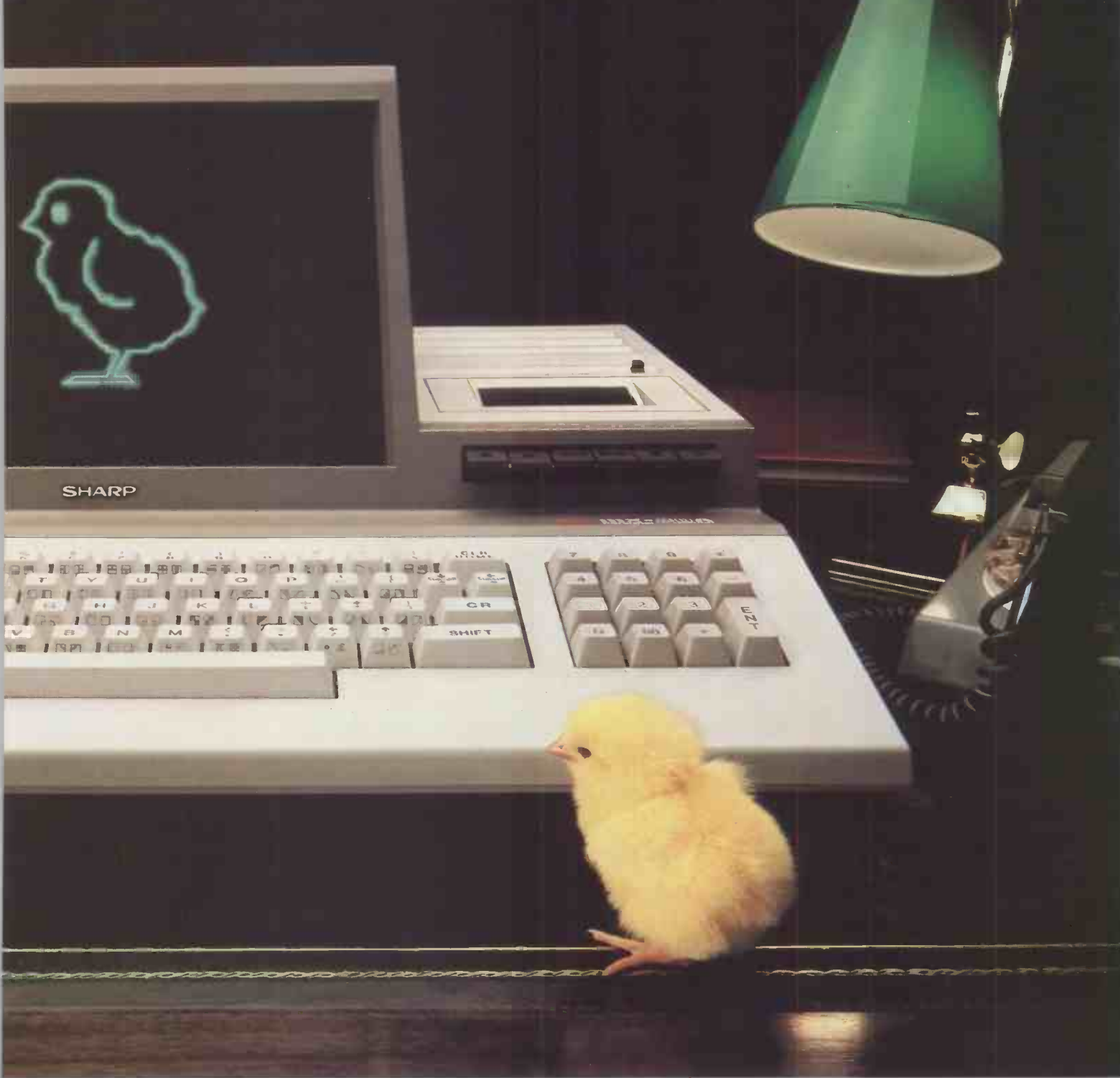

Printer specifications	Optional Printers		
	MZ 80P4	MZ 80P5	MZ 80P6
Printing method	Serial impact dot matrix		
Feed method	Variable sprocket; Friction	Variable sprocket	Variable sprocket; Friction
Kinds of characters	230		
Character make-up	9(W) x 8(H) dot matrix (normal-size characters)		
Number of digits	136/68 per line 160/80 per line	80/40 per line 136/68 per line	
Printing speed	150 cps (normal-size characters)	80 cps (normal-size characters)	
Head sweep direction	Bi-directional		
Other functions	<ul style="list-style-type: none"> • Software-controlled full graphic function • Programmable number of lines per page • Battery-operated memory of HOME position (MZ 80P4 only) 		

Floppy Disc Unit (MZ 80FB)

Two drives per unit; 5.25" dual-sided, double density; 70 tracks; soft-sectored; 16 sectors per track.
Memory capacity 280K bytes per diskette.

To: Sharp Electronics (UK) Ltd, Computer Division, Sharp House, Thorp Road, Newton Heath, Manchester M109BE. Tel: 061-205 2333.
Please send me details of the Sharp MZ 80A

Type of application: _____
Name: _____
Address: _____

The world of
SHARP
where great ideas come to life.



PC:2

Design and specifications subject to change without notice.

CP/M is a trademark of Digital Research Ltd.



DMS

THE ULTIMATE IN DATA MANAGEMENT SYSTEMS

NOW AVAILABLE FOR THE



Compsoft's DMS is everything you ever dreamed possible in computer software. Fast, efficient and reliable, DMS is the only complete integrated system for information management. No matter how unusual your record-keeping problem, DMS will help you to solve it.

DMS needs no programming. Working in conversational English, it creates files, stores records, searches and sorts on multiple criteria, calculates, writes letters, and prints lists, reports, and self-adhesive labels.

Full guides are available for DMS in the Medical World, Personnel, Client Records, Subscription Records and Mailing, Stock, Job costings, Library Records, etc. etc.

Running on the Commodore Pet and virtually any micro running CP/M and MP/M II, all systems cost £400 or less. Every version now includes the DMS letter writer option as standard.

THE COMPSOFT HEADQUARTERS AND TRAINING CENTRE, HALLAMS COURT

Brochures, guides and technical information are free on request from:

DATA MANAGEMENT SYSTEM



Compsoft Limited
Hallams Court
Shamley Green
Nr Guildford, Surrey
England GU4 8QZ
Telephone: Guildford (0483) 898545
Telex: 859210 COMPSFT

GRAPHIPAC

CCSoft's latest product provides some impressive graphics for Gemini and British Micro machines, executing even complex curves with ease. Nick Laurie analyses the effectiveness of this economic package.

MANY OF the current desk-top micros have integral graphics capabilities, but no way of accessing them easily. This package from CCSOFT overcomes many of the problems.

The Gemini G-812 Intelligent Video Card, IVC, and both the Mimi's medium- and high-resolution graphics all suffer from the disadvantage of lack of suitable driving software, at least they did until CCSOFT produced no less than three different versions of its Graphpac package. Although the implementation is slightly different on different machines, the essential commands are much the same for the Gemini Galaxy, the Gemini Multiboard system — provided that it uses an IVC — and the British Micro Mimi 801. Table 1 lists all these commands and describes briefly what they can do. The implementation supplied for this review was used on a Gemini Multiboard system and, for the first time, gave us a chance to put the G-812 IVC through most of its paces in comfort.

A short CP/M program called MBASLINK is used to add the commands directly into your MBASIC 5 vocabulary and to call

up MBASIC itself. Once loaded into a system configured for a minimum 48K CP/M, MBASIC is used as normal but with the added ability to access this package without any help from the user.

One of the most impressive features of this package must surely be the execution speed; Circle was a particularly fine demonstration of this, especially when compared with many of the more commonly used BASIC circle-drawing routines. The fact that a RATIO command is available to correct the height/width factor for different VDUs is an added bonus, as is the fact that you can at last specify an angle directly in degrees instead of having to mess about with radians.

Speedy execution

Plot, with its ability to use polar co-ordinates, came as something of a novelty. Curve drawing has always been something of a bugbear, but the ease and speed with which even quite complex curves can be plotted using this software is enough to endear it for a long time to come.

Graph plotting in MBASIC is now by the

command Down, which permits vertical labelling of axes. The only problem is that it is pure Down; leading “-” signs or horizontal groups of characters cannot easily be mixed directly into the Down command.

Now for a disappointment: PTEST, which is used to check any pixel on the screen and return its condition — on, off or illegal co-ordinates — cannot return its result directly to a BASIC variable. You will have to follow the PTEST command with a Peek of a specified address to see what value has been returned. This is an unmitigated pain when compared to the ease of use of the other functions. A word with Bob Cullen of CCSOFT confirmed that he was not happy with this solution, but that it was the only way it could be implemented at this stage. Since the lightweight supplied for the Gemini IVC card would also return its co-ordinates in the same clumsy way, Cullen felt that this was not the time to implement commands for handling PTEST.

Thoughtful documentation

Most of the remaining commands are self-explanatory if you study the table carefully, although it is important to note that some of them may not be available on the particular version you might want. A full set of sales literature documenting these differences is available from CCSOFT. Included on the disc is a demonstration program which provides some very impressive graphics — all the more impressive when you List and see how easily they have been created.

The documentation is divided into two parts, a command manual describing all the commands available under various versions of Graphpac, and a systems manual which tells the user how to implement Graphpac on a particular machine. Properly printed and well thought out, these manuals do credit to a product which, at £35, might expect to be far less well served.

Economy Basic

Apart from the Gemini Galaxy and Multiboard Microsoft BASIC 5 CP/M versions, which are very similar, CCSOFT supplies an 8K floating-point BASIC known as Economy Basic, for use with cassette-based Gemini systems. Economy Basic lacks trigonometric and string-handling functions, but includes the Graphpac commands and brings this impressive controller within reach of the non-disc user.

The British Micro Mimi, a 64K CP/M machine, has its own internal graphics capability with both 256 by 256 low-resolution and 512 by 256 high-resolution modes. The Mimi package from CCSOFT is known, once again, as Graphpac. It is booted into a 47K maximum CP/M where it behaves as an extended Bios, but still allows all normal CP/M software to run

(continued on page 64)

Table 1. Graphpac commands.

No one version includes all these commands but all versions include most of them. Check with your supplier for further details.

CLS — clear screen
GS and NS — toggle graphic/normal modes
CLEOL — clear to end of line
SCROLL N — limit screen scrolling to the bottom N lines of the display
SCREEN CC,RR — move cursor to column CC of Row RR
VBAR CC,RR,N — draw a vertical bar of height N at co-ordinates CC,RR
VBARH — a half-tone version of VBAR
DOWN CC,RR — print a vertical string of characters
FCON and FCOFF — enable/disable toggle for trapping entry or use of illegal co-ordinates
G256 (Mimi) — use the low-resolution graphics mode
G512 (Mimi) — use the high-resolution graphics mode
PSET — set a specified pixel Bright
PRESET — set a specified pixel Dark
PTEST (+PEEK) — test the condition of a pixel
STARTAT — set a start position for the (invisible) cursor
PENUP, or PU — move the invisible cursor

without affecting the pixels it passes through
PENDOWN (PD) — set any pixels touched by the invisible cursor
PENFLIP (PF) — invert them this time
PENERA (PE) — now erase them
PENRET (PR) — put the invisible cursor back to the last Startat location
DRAWTO X, Y — move the invisible cursor to a specified location
DRAW X,Y — move the invisible cursor to a relative X,Y point, not to an absolute address
PLOT A,D — move it using angle and distance information
DOCAP — flip the pixel at the current, invisible, cursor position
CIRCLE R,A1,A2 — draw an arc or even a complete circle
RATIO N — adjust the width/height ratio of a circle to allow for differently shaped VDU screens
PSI “Dr:Name” — save a screen image to disc
GSI “Dr:Name” — get a screen image from disc
CAP — print the invisible cursor, called the Current Active Point in the manual
CAP@ CC,RR — print it at a particular point
LCAP — print it on a printer
SPOKE — Poke a screen location

THINKING ABOUT BUYING A COMPUTER SYSTEM? TALK TO DATALECT FIRST!

COMMODORE®

No. 1 best seller in the U.K. Tackles your bookkeeping, stock control and word processing. This system is reliable and superb value.



APPLE®

One of the most versatile on the market. Expandability up to 48 kbytes of user memory, supported by a large range of programs and peripherals.

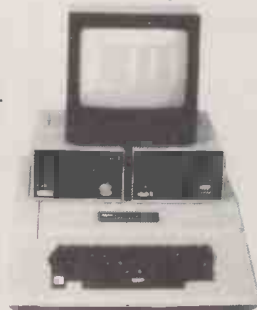

HEWLETT® PACKARD

A portable (only 20 lbs) specialist computer with a fully integrated keyboard, display and printer.



ACT SIRIUS 1

A revolutionary personal computer developed from the outset for business and professional use.



® Registered trademarks of Commodore, Apple Inc., Hewlett Packard, ACT.

...because who else provides all this—at a price you can afford

We offer you a choice of these budget priced, easy to operate microcomputers. Starting in price from an amazing £200 for a computer, £1,500 for a complete system. All come with a versatile range of programs to meet today's modern business needs.

Try one out for yourself

If you're not sure how a microcomputer can help, call in at our WOKING or CROYDON SHOWROOMS.

Keeping you going

Fast reliable SERVICE if you're based in London and the South.

Buying your system

Attractive terms, leasing and the best deals available in London and the South.

Remember, when you buy from Datalect you're getting 10 yrs EXPERTISE, SERVICE, ADVICE and TRAINING and the best after-sales care.

SHOWROOMS:

CROYDON. 7, St. Georges Walk, Croydon, Surrey.
Tel: 01-680 3581
WOKING. 32, Chertsey Road, Woking, Surrey.
Tel: 04862 63901

THE BEST PRICES AND THE BEST SERVICE IN THE SOUTH

DATALECT

COMPUTERS

Your computer company for London and the South

Please send me details and price list.

Name _____
Company _____
Position _____
Address _____
_____ Post Code _____

DATALECT Computers.
Dept. 33/35 Portugal Rd., Woking, Surrey GU21 5JF

● Circle No. 136

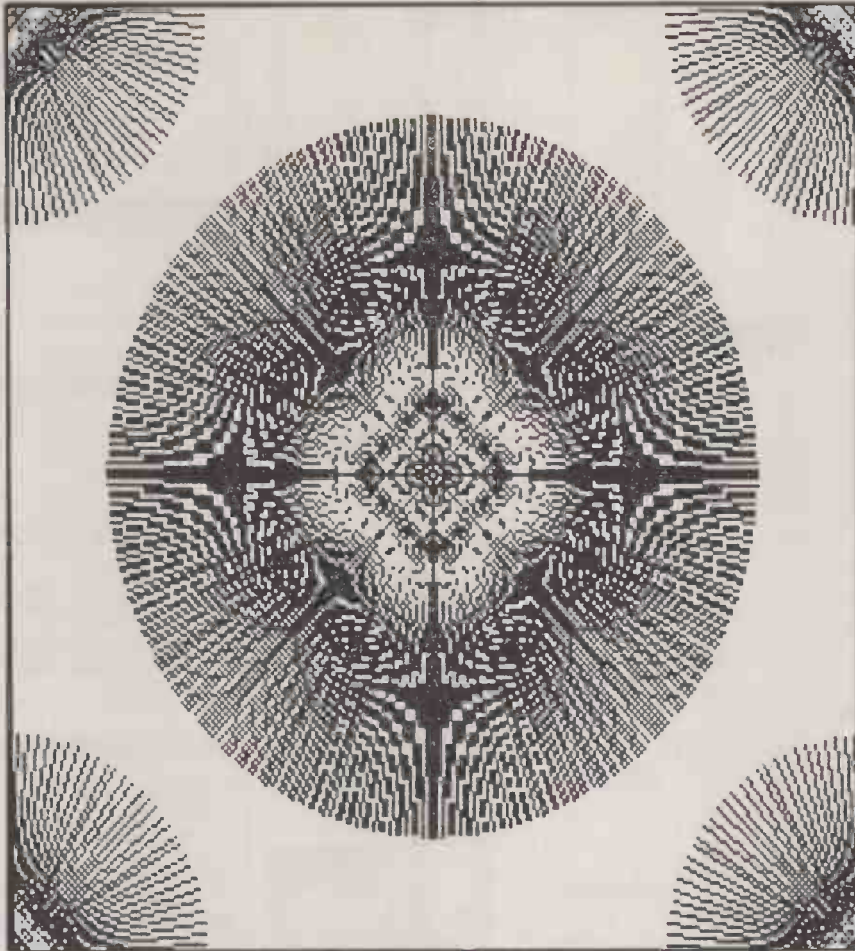

(continued from page 61)

correctly. An MBaslink, as described for the Gemini, is used to link the new commands into your own MBasic 5. CCSOft does not include a copy of Basic with the CP/M versions of Graphpac, so make sure you have a version 5 release of MBasic before you order.

Conclusions

- At £35 — or £25 for the Economy Basic — Graphpac is very good value for money. By incorporating these sophisticated and fast routines into your ordinary MBasic, you can be sure that your existing software is not going to become suddenly redundant — a regular problem with many software additions.
- The lack of light-pen commands might be considered a handicap for some users, but until low-cost light-pens reach a higher level of sophistication I, for one, will not really miss them.
- CCSOft's customer service has always been impressive — even on a Sunday afternoon, when the package was being tested, they still came up smiling!
- Any system using a Gemini IVC really ought to include Graphpac as a simple, yet thorough, way of accessing its complex functions.
- For the Mimi 801 user Graphpac is an undoubted must if you want to get the best out of Mimi's almost inaccessible — but very good — graphics capabilities. □

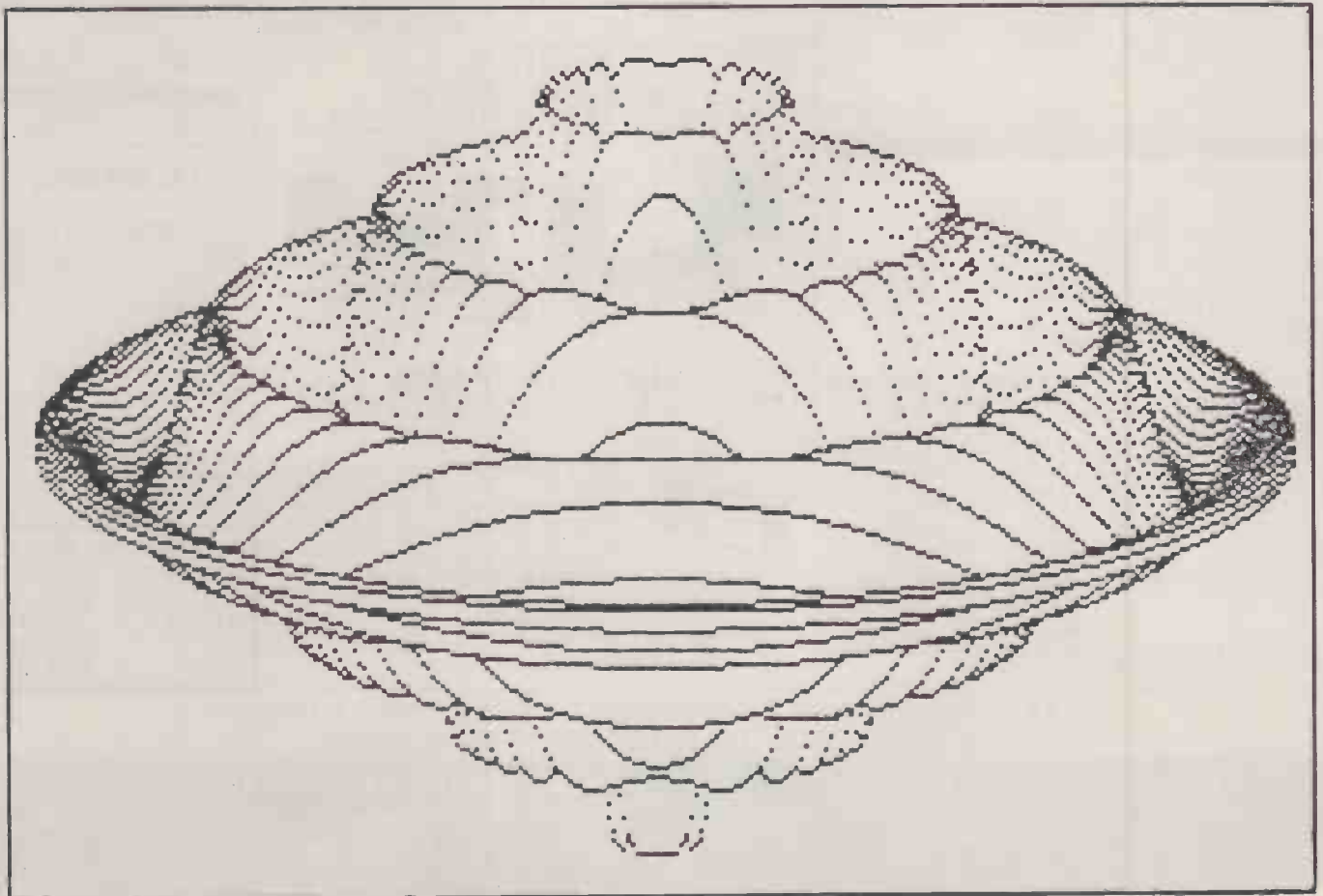

ACT

pulsar

See us at the
Personal Computer World Show
The Barbican 9-12 Sept. 1982.

INDUSTRY-STANDARD 16-BIT BUSINESS SOFTWARE

The new PULSAR business software is 16-bit software specially developed for new generation 16-bit personal computers.

It's inherently faster and more powerful than traditional 8-bit software.

The result: More and more business users are choosing PULSAR, making it one of the industry standards on 16-bit personal computers.

Only PULSAR meets the five key requirements for 16-bit business software:

PORTABILITY

PULSAR is primarily written in the PASCAL portable language. So your investment in software is protected, regardless of how often you change your system.

PEDIGREE

PULSAR has been developed by ACT's own software engineers as a true 16-bit system. And ACT has more than 15 years experience in business software — computer bureaux using ACT programs produce more than 3 million statements every year and handle business applications

for more than 2000 companies. PULSAR incorporates many facilities that were previously available only on large mainframe computers.

INTEGRATION

ACT supplies integrated business software, linking every aspect of business accounting. Now with PULSAR, this integration is taken a stage further with word processing and business management tools able to share information and files with accounting applications.

USER-FRIENDLY

PULSAR is really easy to use. Documentation is to the highest standards in the industry, taking the operator step by step through the system. A simple question and answer routine on the computer screen prompts the user at every turn.

TOTAL SUPPORT

ACT is used to providing on-going support for its users. Not only is there a "hot-line" to resolve queries, but also a fully equipped training school open to all PULSAR users.

THE PULSAR RANGE...

PULSAR ACCOUNTING

Pulsar Sales Ledger
Pulsar Purchase Ledger
Pulsar Nominal Ledger
Pulsar Payroll

PULSAR ORDER PROCESSING

Pulsar Stock Control
Pulsar Invoicing
Pulsar Order Handling



PULSAR FINANCIAL MANAGEMENT

Pulsar Data Analysis
Pulsar MicroModeller
Pulsar SuperCalc
Pulsar MultiPlan

PULSAR OFFICE SYSTEMS

Pulsar WordStar (word processing)
Pulsar Mailmerge (mailing)
Pulsar Select (word processing)

● Circle No. 138



pulsar

16 BIT-SOFTWARE
FOR 16 BIT
PERSONAL COMPUTERS

The ACT octagon encapsulates our philosophy of providing users with a single source for their computing solutions. ACT products include personal computers — network micro-computer systems — turnkey mini computers and a total range of services, including software development, computer field engineering, computer supplies, and a complete range of Bureau services.

The eight specialist ACT companies are each leaders in their field and are wholly owned by Applied Computer Techniques (Holdings) p.l.c., one of Britain's largest and most successful computer companies.

For more information on 16-bit Pulsar Software complete the coupon and post to ACT (Microsoft) Ltd., FREEPOST, Birmingham B16 8BR or phone 021-454 8585

I'm buying a 16-bit personal computer. Tell me more about the new 16-bit PULSAR software.

Name: _____

Position: _____

Company: _____

Address: _____

Telephone: _____

Application _____ PCB

65

Don't let its size fool you.

If anything NewBrain is like the Tardis.

It may look small on the outside, but inside there's an awful lot going on.

It's got the kind of features you'd expect from one of the really big business micros, but at a price of under £200 excluding VAT it won't give you any sleepless nights.

However, let the facts speak for themselves.

You get what you don't pay for.

NewBrain comes with 24K ROM and 32K RAM, most competitors expect you to make do with 16K RAM.

What's more you can expand all the way up to 2 Mbytes, a figure that wouldn't look out of place on a machine costing ten times as much.

We've also given you the choice of 256, 320, 512 and 640 x 250 screen resolution, whereas most only offer a maximum of 256 x 192.

Big enough for your business.

Although NewBrain is as easy as ABC to use (and child's-play to learn to use) this doesn't mean it's a toy.

Far from it.

It comes with ENHANCED ANSI BASIC, which should give you plenty to get your teeth into.

And it'll also take CP/M® so it speaks the same language as all the big business micros, and feels perfectly at home with their software.

NO OTHER MICRO HAS THIS MUCH POWER IN THIS MUCH SIZE FOR THIS MUCH MONEY.



So as a business machine it really comes into its own.

The video allows 40 or 80 characters per line with 25 or 30 lines per page, giving a very professional 2000 or 2400 characters display in all on TV and/or monitor. And the keyboard is full-sized so even if you're all fingers and thumbs you'll still be able to get to grips with NewBrain's excellent editing capabilities.

When it comes to business graphics, things couldn't be easier. With software capabilities that can handle graphs, charts and computer drawings you'll soon be up to things that used to be strictly for the big league.

Answers a growing need.

Although NewBrain, with its optional onboard display, is a truly portable micro, that doesn't stop it becoming the basis of a very powerful system.

The Store Expansion Modules come in packages containing 64K, 128K, 256K or 512K of RAM. So, hook up four of the 512K modules to your machine and you've got 2 Mbytes to play with. Another feature that'll come as a surprise are the two onboard V24 interfaces.

With the aid of the multiple V24 module this allows you to run up to 32 machines at once, all on the same peripherals, saving you a fortune on extras.

The range of peripherals on offer include dot matrix and daisy wheel printers, 9", 12" and 24" monitors plus 5 1/4" floppy disk drives (100 Kbytes and 1 Mbyte) and 5 1/4" Winchester drive (6-18 Mbytes).

As we said, this isn't a toy.

It doesn't stop here.

Here are a couple of extras that deserve a special mention.

The first, the Battery Module, means you won't be tied to a 13 amp socket. And, even more importantly, it means you don't have to worry about mains fluctuations wreaking havoc with your programs.

The ROM buffer module gives you a freedom of another sort.

Freedom to expand in a big way. It gives you additional ROM slots, for system software upgrades such as the Z80 Assembler and COMAL, 2 additional V24 ports, analogue ports and parallel ports.

From now on the sky's the limit.

Software that's hard to beat.

A lot of features you'd expect to find on software are actually built into NewBrain so you don't need to worry about screen editing, maths, BASIC and graphics.

However, if you're feeling practical you can always tackle household management, statistics and educational packages. And because NewBrain isn't all work and no play, there's the usual range of mind-bending games to while away spare time.

Waste no more time.

To get hold of NewBrain you need go no further than the coupon at the bottom of the page.

With your order we'll include a hefty instruction manual so you'll know where to start, and a list of peripherals, expansion modules, and software so you'll know where to go next.

● **Circle No. 139**

© CP/M is the registered trade mark of Digital Research Inc.



NewBrain, Grundy Business Systems Ltd., Grundy House, Somerset Road, Teddington TW11 8TD.

Each NewBrain order will include a FREE comprehensive user manual, a catalogue of expansion modules and peripherals, and a detailed list of available software.

Please send me the following:-

Quantity	Item	Price per item (Inc. VAT & p&p)	Total
	NewBrain A	£233.00	
	NewBrain AD with onboard single line display	£267.50	
	Printer	£466.00	
	Monitor 12"	£142.50	
	Total £		

I enclose a cheque/Postal Order for £_____ payable to Grundy Business Systems Reader Account.
NewBrain, Grundy Business Systems Ltd., Grundy House, Somerset Road, Teddington TW11 8TD.

Please debit my Access Card No: _____ my Barclaycard No: _____

Signature _____

Name _____

Address _____

Postcode _____ P C 8

Registered Number 1522978

VAT Number 358661618

Please allow up to 28 days for delivery.

NEWBRAIN

THE LOW COST HIGH PERFORMANCE MICRO FOR THE BUSINESS PROFESSIONAL

UP TO 10M BYTES OF INTEGRAL DISK CAPACITY!

HARDWARE FEATURES

- Powerful Z80 processor. • 64K memory.
- CP/M* operating system.
- Detachable QWERTY keyboard, numeric and cursor control pads, and 24 programmable function keys.
- Floppy and Winchester disk options - 350 Kbytes to 10 Mbytes.
- Instrumentation interface.
- Attractive desk-top styling.
- Robust, reliable and easy to maintain.

SOFTWARE

When it comes to software, the M-Three maintains the highest standards throughout. First of all, it is equipped with a CP/M* operating system and therefore the user has every opportunity to select programs from the vast

range of CP/M* based applications software generally available in the micro-computer market.

A comprehensive range of ready-to-run business applications packages is available from us for immediate use with your Ukom M-Three.

MAP (Modular Accounting Package) is a fully integrated accounting system featuring INVOICING SALES LEDGER, PURCHASE LEDGER, NOMINAL LEDGER. Other Applications include STOCK CONTROL, WORD PROCESSING, PROSPECT MAILING, AND PAYROLL.

OASIS is also available.

In addition, if you've something special you want the M-Three to do, then take your choice of a range of high-level languages. Programming is no problem, using, for instance, BASIC or COBOL.



Please send me full details of Ukom M-Three today

UKOM BUSINESS SYSTEMS

Ukom Systems Ltd.,
11 Connaught Place, London W2 2ET
Tel: 01-258 0077 Telex: 299067 Slave G

* CP/M is a registered trade mark of Digital Research

● Circle No. 140

Name _____

Company _____

Address _____

Tel _____

68

"The best value for money on the small business systems market"

Which Computer? Magazine

SUPERBRAIN

A smart, fully self-contained desk-top unit – that's the SUPERBRAIN microcomputer. It will operate as a complete business system, as a word processor (allied to a high quality printer) and as an intelligent terminal.

- 320K, 680K and 1.5 MB disc drives
- Wide range of standard packages
- Full graphics facility
- Nationwide dealer network
- Hard Discs available too – integral or separate



SUPERBRAIN is ideal for both first time buyers needing a general purpose machine, and for users wishing to upgrade from a personal microcomputer system. Its CP/M operating system will handle the most sophisticated programs. Twin Z80 microprocessors and an RS232 communications port make it easy to extend the system in the future.

The Icarus dealer network

A.P. LTD, Maple House, Mortlake Crescent, CHESTER CH3 5UR. Tel: 0244 46024

BASIC BUSINESS SYSTEMS, 61 Loughborough Road, WEST BRIDGEFORD, Nottingham. Tel: 0602 819713

BUSINESS INFORMATION SYSTEMS, 602 Triumph House, 189 Regent Street, LONDON. Tel: 01 437 1069

BORDER COMPUTING LTD, Dog Kennel Lane, BUCKNELL, Shropshire. Tel: 054 74 368

CAMBRIDGE MICRO COMPUTERS, Cambridge Science Park, Milton Road, CAMBRIDGE. Tel: 0223 314666

COMMONSENSE COMPUTING LTD, P.O. Box 7, BIDEFORD, Devon. Tel: 02372 4795

COMPUTECH SYSTEMS, 168 Finchley Road, LONDON, NW3 6HF. Tel: 01 794 0202

CONQUEST COMPUTER SALES LTD, 92 London Road, BENFLEET, Essex. Tel: 03745 59861

CULLOVILLE LTD, Thornfield, Woodhill Road, SANDON, Chelmsford, Essex. Tel: 024 541 3919

DATA PROFILE, Lawrence Road, Green Lane, HOUNSLOW, Middlesex. Tel: 01 446 1917

DATA WARE, 48 Eaton Drive, KINGSTON, Surrey KT2 7QX. Tel: 01 546 2984

DAYTA, 20h West Street, Wilton, SALISBURY, Wilts. Tel: 0722 74 389

DRAGON SYSTEMS LTD, 37 Walter Road, SWANSEA, W. Glam. Tel: 0792 474498

DUPLEX COMMUNICATIONS, 2 Leire Lane, Dunton Bassett, Lutterworth, LEICESTERSHIRE. Tel: 0455 209131

ELSTREE COMPUTING LTD, 12 Elstree Way, BOREHAMWOOD, Herts. Tel: 01 207 2000

ESCO COMPUTING LTD, 154 Cannongate, EDINBURGH. Tel: 031 557 3937

ESCO COMPUTING LTD, 40a Gower Street, GLASGOW G5 1PH. Tel: 041 427 5497

EFFICIENT BUSINESS SYSTEMS, 9 Clarence Street, BELFAST 1, N. Ireland. Tel: 0232 647 538

EMTEK COMPUTERS LTD, 40 South Furzeham Road, BRIXHAM, Devon. Tel: 08045 3566

FAST COMPUTING, 52 High Street, HENLEY-IN-ARDEN, West Midlands. Tel: 041 438 2813

B. FITTON, 97 Melbourne Road, ROYSTON, Herts. Tel: 0763 41949

FOREST ROW COMPUTERS, 53 Freshfield Bank, FOREST ROW, East Sussex. Tel: 034282 4397

J & F GROVER LTD, 10 Barley Mow Passage, LONDON W4 4PH. Tel: 01 944 647

G.I.C.C., P.O. Box 519, Manama, Bahrain.

JAEMMA LTD, Unit 24, Lee Bank House, Holloway Head, Lee Bank, BIRMINGHAM. Tel: 021 643 1609

JENNINGS COMPUTER SERVICES, 55/57 Fagley Road, BRADFORD, W. Yorks. Tel: 0274 637867

KENT BUSINESS SYSTEMS LTD, 85 High Street, Ramsgate, Kent. Tel: 0843 687816

LAWMAR BUSINESS SYSTEMS, 1 Paterson Drive, Woodhouse Eaves, LOUGHBOROUGH, Leics. Tel: 0509 890900

LONDON COMPUTER CENTRE, 43 Grafton Way, LONDON W1. Tel: 01 388 5721

M.G. ENTERPRISES, 32 Rue Victor Hugo, 92800 Puteaux, France. Tel: 0103315060655

MASS MICROS, Wellson House, Brownfields, WELWYN GARDEN CITY, Herts. Tel: 96 31736

MICROAGE LTD, 53 Acton Road, LONG EATON, Nottinghamshire. Tel: 06076 64264

MICROSERVE LTD, 811 Kennedy Way, Pelham Road, IMMINGHAM. Tel: 0409 72346

MICROCARE COMPUTING LTD, 18 Havarden Road, NEWPORT, Gwent. Tel: 0633 278040

MICROCOMPUTER CONSULTANCY, Lyngen, Oldhill Wood, Studham, DUNSTABLE, Beds. Tel: 01 351 2488

NASTAR COMPUTER SERVICES LTD, Ashton Lodge, Abercrombie St., CHESTERFIELD. Tel: 0266 207048

NICOMTECH LTD, The Old Mill, Anthony Passage, SALTASH, Cornwall. Tel: 07555 2719

OMEGA ELECTRIC LTD, Flaxley Mill, Flaxley Road, MITCHELDEAN, Glos. Tel: 045 276 532

PROTOCOL COMPUTER PRODUCTS, 49 Beckenham Lane, Shortlands, BROMLEY, Kent.

RANMOR COMPUTING LTD, Nelson House, 2 Nelson Mews, SOUTHBEND-ON-SEA. Tel: 0702 339262

ROGIS SYSTEMS LTD, Keepers Lodge, Frittenden, NR. CRANBROOK, Kent. Tel: 058 080 310

S.D.M. COMPUTER SERVICES, Broadway, BEBINGTON, Merseyside L63 5ND. Tel: 051 608 9365

SAPPHIRE SYSTEMS, 19-27 Kents Hill Road, BENFLEET, Essex. Tel: 03745 59756

SHEFFIELD COMPUTER CENTRE, 227 London Road, SHEFFIELD S2 4NF. Tel: 0742 53519

SISCO LTD, 4 Moorfields, LONDON, EC2Y 9AA. Tel: 01 920 0315

SORTFIELD LTD, E. Floor, Milburn House, Dean Street, NEWCASTLE-UPON-TYNE. Tel: 0632 329593

SPOT COMPUTER SYSTEMS LTD, New Street, Kelham Street Indus. Estate, DONCASTER, S. Yorks. Tel: 0302 25159

STAG TERMINALS LTD, 30 Church Road, Teddington, Middlesex. Tel: 01 943 0777

STUKELEY COMPUTER SERVICES, Barnhill, STAMFORD. Lines. Tel: 0780 4947

TERMACRE LTD, 126 Woodwards Rd., LONDON SE22 8TU. Tel: 01 693 3037

THAMES VALLEY COMPUTERS, 10 Maple Close, MAIDENHEAD, Berks. Tel: 0628 23532

TURNKEY COMPUTER TECHNOLOGY, 23 Calderglen Road, St. Leonards, EAST KILBRIDE. Tel: 03552 39466

WORD PERFECT, Old Town Hall, Box 148, READING, Berkshire. Tel: 0734 589068

For further details, or if you want to become a dealer yourself, contact:

ICARUS

Computer Systems Ltd.

Icarus Computer Systems Ltd. Deane House 27 Greenwood Place London NW5 1NN Tel: 01-485 5574 Telex: 264209

● Circle No. 141

Despite frequent complaints, CP/M has so far remained the premier Z-80 operating system. David Watt assesses the virtues of another contender.

FOR MICRO SYSTEMS Digital Research's CP/M is much the most popular single-user operating system. It achieved this enviable position by being the first operating system which was easily transportable to different hardware, having a relatively small portion called Bios which needs to be rewritten for different systems.

Yet there are complaints about CP/M's difficulty of use, poor error reporting and poor documentation. In the past 18 months, there has been considerable interest in multi-user systems though MP M, Digital Research's answer to this demand, has been fraught with difficulties. As a result, some other operating systems have begun to make their name in the market, one of the most promising of which is Oasis.

Oasis was developed as an operating system for Z-80 systems by Phase One Systems of Oakland, California. Phase One, who was founded in 1977, now has about 25 staff and sales of about \$2.5 million a year.

The operating systems may be supplied as a single-user or multi-user version, both being completely compatible. Included with the operating system are the following system development and support tools:

Exec — an interactive command language interpreter

Table 1. Oasis commands.

Disc-maintenance system diagnostics		
Archive	Recover	Memtest
Backup	Repair	Seek
Initdisc	Restor	Verify
Inttape		
File maintenance		
Assign	Erase	Peek
Attach	FileList	Rename
CopyFile	GetFile	Sectore
Create	Kill	Sort
DumpDisk	List	State
Edit	Mount	TextEdit
Program development and execution		
Basic	Filt8080	Macro
Debug	Force	Patch
Edit	IntelHex	Relocate
Exec	Link	Run
Communications Oasis parameter maintenance		
Bisync	Account	Show
Masibox	Change	Spooler
Msg	Load	Start
Receive	OwnerChange	Stop
Send	Set	Sysgen
Terminal	Share	Unload

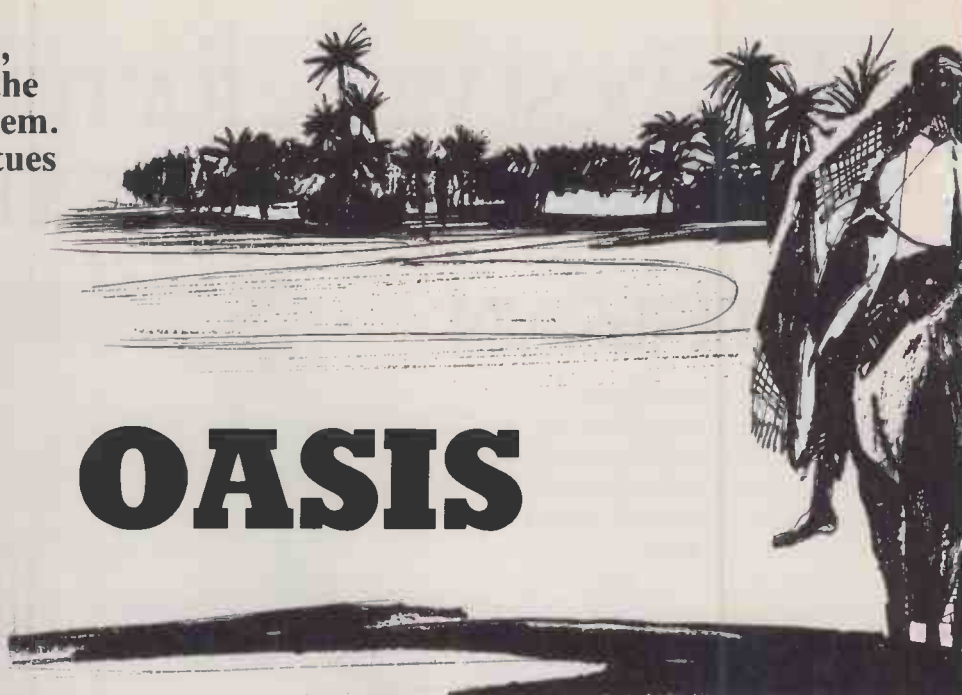

OASIS

Basic — interpreter/compiler
 Edit — a line-oriented editor
 Script — a text-formatting utility
 Comm — a suite of programs for communications between terminals or other systems
 Macro and Link for assembler-language programming

On initialising or booting the system, from disc, the Nucleus, Command String Interpreter device drivers and terminal class files are loaded from disc. The Nucleus is the core of Oasis, and handles the basic tasks of job scheduling, interprocess communication, memory management and file management.

The Command String Interpreter, CSI, checks the syntax of commands and loads and executes them. Table 1 lists the commands available. In most cases only one or two characters have to be typed, and there is an integer calculator. It uses reverse Polish notation, which means if you want to perform an operation on two numbers you have to type the two numbers first followed by the operand, thus typing

123 456 +

gives the result 579. This may seem a bit strange to use at first, but it is very simple to implement and efficient in operation.

The device drivers contain the routines to control input and output to the various peripherals used by the system: discs, printers, tapes, terminals. With a very diverse range of VDUs now available for using with computer systems, problems can arise if different types of VDU are used on the same system. In many operating systems different drivers have to be written for each VDU.

In Oasis a standard set of terminal functions is defined and a set of parameterised terminal class files is provided to set out the control character sequences used by different types of terminals. When configuring the system you can use

&BegStack	&Index	&Retcode
&BegType	&Len	&Skip
&Cat	&Line	&Space
&Control	&Lit	&Stack
&CRT	&Null	&Sub
&End	&Page	&Typ
&Error	&Quit	&Until
&Esc	&Read	&Wait
&Foto	&Repeat	&While
&If		

Table 2. Exec keywords.

the Attach command to assign a class file to a particular VDU. The Oasis manual has a list of about 30 different class files, although not all of them were supplied with our evaluation system. The manual describes how to set up new terminal class files if there is more for your particular VDU.

When operating as a multi-user system, different accounts may be set up for each user of the system. Various levels of security are provided. Files created by a particular user belong to his account and may not be accessed by other users unless a file is designated as shareable, using the command Share.

All files in the System account are shareable but an account may be assigned a privilege level in the range 0 to 5. Only commands with a privilege level less than or equal to the account privilege may be used when in that account.

In order to use the system when in multi-user mode, the user has to LogOn to an account. An optional password may be required when logging on. An asterisk is displayed for each character of the password as it is typed in. The LogOn and LogOff commands may automatically update a history file providing a record of who is using the system.

The Z-80 processor can address 64K of memory at one time. Multi-user systems require more memory than this.



Auto	Load	Save
Bottom	Locate	Step
Break	LPList	Top
Change	LPXRef	Trace
Continue	Modify	Trace Vars
Delete	Name	Unbreak
Help	New	Untrace
Indent	Quit	Vars
Length	Renumber	XRef
List	Run	

Table 3. Oasis Basic commands.

Oasis is a bank-switching system. If more than 64K of memory is available to the system the first 16K is designated as shareable, non-switching memory. This contains the Nucleus plus certain re-entrant programs which may be used by all users.

Remaining memory is then split into separate banks; the total size of each bank plus shareable memory must not exceed 64K. Individual banks may be further split into smaller user partitions if required. When a program is loaded it remains permanently in memory, and there is no need for programs to be swapped out to disc.

Table 5. Oasis Basic functions.

Abs(N)	EXT\$(A\$,N1,N2)	Match (A\$,B\$)	RPad\$(A\$,N)
Asca\$	Fix(N)	Max(N1,N2)	PRT\$(N1,N\$)
AT\$(N1,N2)	Float(N)	Mid\$(A\$,N1,N2)	RTrim\$(A\$)
ATN(N)	Format\$(N,A\$)	Min(N1,N2)	SCH(N1,A\$,B\$)
Bin(A\$)	Hex(A\$)	Mod(N1,N2)	Sel(A\$)
BinOf\$(N)	HexOf\$(N)	NBR(A\$)	SGN(N)
CHR\$(N)	INP	Oct(A\$)	Sin(N)
COS(N)	INS\$(A\$,N1,N2,B\$)	OctOf\$(N)	Space\$(N)
CRT\$(A\$)	Int(N)	OVR\$(A\$,N1,N2,B\$)	SQR(N)
Date\$(N)	Left\$(A\$,N)	Page(N)	STR\$(N)
Day(A\$)	Len(A\$)	Pi	Tan(N)
Del\$(A\$,N1,N2,B\$)	Line(N)	Pos(N)	Time\$(N)
DTE\$(A\$)	Log(N)	Rep\$(A\$,N1,N2,B\$)	Trim\$(A\$)
EOF(N)	LPAD\$(A\$,N)	Right(A\$,N)	USR(N1,N2)
ERL	LRL(N1,N2)	Rnd	USR\$(N,A\$)
ERR	LSL(N1,N2)	Round(N1,N2)	Val(A\$)
Exp(N)	LTrim\$(9\$)		

The system turns on each bank in turn and executes a portion of code until either a predetermined time has passed or an input or output task is initiated. Because the processor would normally be idle during input or output it can be used more efficiently, but it appears to end-user as though the system is working exclusively on his task.

Four types of files are implemented by Oasis: sequential, direct, indexed and keyed. The routines for handling these files are contained within the Nucleus, and are thus available to all programs running under Oasis. Thus, indexed files may be accessed by assembler or Basic programs and are maintained in exactly the same format. Oasis also features automatic record locking and optional file locking; again the Nucleus manages these functions.

Indexed and keyed files are very similar in format. When adding a record, a hashing algorithm is used on the key to find the position in the file to write the record. If that position is already in use the key is rehashed to find a new location. A similar process is used when locating a record. Only one key is allowed for a file, and that key may be up to 128 characters long.

Indexed files differ from keyed files in that each record has associated with it a pointer to the next record in sequence. This means records can be read in sequence, but makes the process of adding a record slightly longer. Sequential access can start from any point in the file even if the first key specified is not found. The hashing technique for indexed and keyed files is reasonably efficient until the file becomes 70 to 80 percent full, so it is best to allocate extra space when creating the files.

Indexed and keyed files may have a key of up to 128 characters. The hashing technique does not permit duplicate keys — that is, two or more records in the same file with identical keys — though this can be simulated by adding a unique code to the end of a key.

A comprehensive job-control language, Exec, is provided with Oasis. It allows complex processes involving the

Case	If-Then	Put Port
Cend	Input	Quit
Chain	Let	Randomize
Clear	Link	Read
Close	LInput	Read Next
Common	Mat	Rem
CSI	Mat Input	Restore
Data	Mat Print	Resume
Def FN	Mat Read	Return
Delete	Mat Write	Run
DFM	Mount	Select
Else	Next	Sleep
End	On Error Goto	Stop
FNEnd	On Goto	Then
For	On Gosub	Wait
Get	Open	Wait Device
Device	Option	Wait Port
Get Memory	Otherwise Print	Wait Memory
Get Port	Print Using	Wend
Gosub	Put Device	While
Goto	Put Memory	Write

Table 4. Oasis Basic statements.

use of several commands to be set up. Exec features conditional execution, branching, loops and the &CRT command to enable direct control of VDUs.

There are several Help facilities within Oasis. When using the system commands, Help may be used to list all the commands available, or information may be displayed on how to use a specific command. Help is also available when using the Basic interpreter to list the Basic commands, statements and functions. A useful feature when displaying long lists is the VDU screen wait, which occurs when a screenful of data has been displayed: the system waits for the space bar or Return key to be pressed before displaying the next screen. This feature can be switched on and off.

Basic is supplied as the standard high-level language for use with Oasis. RMCobol, Fortran 77 and Pascal compilers are also available.

Oasis Basic is both an interpreter and compiler, which means programs may be developed using the interpreter to give flexibility of modification and ease of debugging. When programs are debugged they may be compiled, making them faster to run and more economical with space on disc and in memory. Software suppliers need not supply the source code. One problem with this approach is that it is possible to write larger programs when they are compiled than when using the interpreter, but in this case the interpreter may still be used to test portions of the program.

Oasis Basic is a flexible implementation, whose features include multiple-line user functions using the Def FN, FNEnd combination; structured programming constructs, including Case and While-Wend; matrix input, output and assignment; interfaces to assembler routines, USR, and system commands, CSI; and 13-digit BCD arithmetic or floating-point values in the range 10^{+126} to 10^{-126} . The commands, statements and functions pro-

(continued on next page)

	BM1	BM2	BM3	BM4	BM5	BM6	BM7	BM8
Interpreter using								
floating-point variables	3.7	9.3	26.0	29.1	32.1	57.5	81.2	17.1
integer variables	1.9	6.2	14.1	14.1	17.2	31.1	50.9	-
Compiler using								
floating-point variables	3.6	6.8	21.8	24.8	26.7	47.1	65.6	16.7
integer variables	1.3	4.2	9.5	9.6	11.8	21.3	34.6	-

Table 6. Kilobaud benchmarks for Oasis Basic on CIS 300.

(continued from previous page)

vided are listed in tables 3, 4 and 5.

The compiler seems to be reasonably efficient, with 30 percent improvement in timings obtainable when using integer variables. Floating-point arithmetic offers less of an improvement, averaging around 15 percent. Results using the Kilobaud benchmarks on a CCS 300 micro are shown in table 6.

Among the other useful facilities provided with Oasis is Edit, a flexible line-oriented editor whose commands include Modify, which allows a line to be edited on a character-by-character basis. You can move the cursor along the line, inserting or deleting characters as you go. Many of Edit's commands are also available when using the Basic interpreter to type in programs.

Script is the text-formatting processor which is provided for word-processing applications. Combined with a screen-oriented editor like Magic Wand this would make a very useful system for word processing.

Communications are provided in the shape of Bisync, an IBM 2780/3780 emulator, MSG and Mailbox for sending messages to other users, and Receive, Send and Terminal for emulating a terminal to another system.

The documentation for Oasis is supplied in a single manual split into sections covering an introduction to the system and the system commands Exec, Basic, Edit, Script, the communications programs, Macro, and the link editor Link. It is well laid out, and though no indexes are provided it is quite easy to find what you want. The manual always explains computer terms when they need to be used but avoids the tiresome jokey style of some micro documentation.

Phase One has recently announced Oasis 16 for the new 16-bit systems; C is also available, as Oasis 16 is being written in this language. There are one or two 8086-based systems with Oasis 16 already implemented, and there are expected to be more by the end of the year. A version

for 68000-based systems is expected early in 1983. Oasis 16 will complement the existing operating system offering upwards compatibility from Z-80 systems.

Conclusions

● Oasis is a very flexible system. There are a considerable number of options in the way the system may be set up. The terminal class files are a very good idea, as they enforce consistent approach to handling terminal functions and make it easier to attach different terminals to the system.

● The routines to control disc-file handling are all part of the Nucleus, not the various languages available. So a file written by an assembler program could be read by a Basic program. Index sequential and keyed files are implemented, and file and automatic record locking are available. The index sequential access method used is based on using hash tables rather than the now more popular balanced tree structures, and does not permit multi-key files, or records with duplicated keys. Oasis 16, when it is implemented, will feature balanced-tree indices with these options.

● Oasis is certainly transportable, and is available on at least 20 Z-80-based systems including Altos, California Computer Systems, Cromemco, Godbout, Morrow Thinker Toys, North Star, Onyx, TRS 80 model II, and Vector Graphics. □

For the best PET software...

COMMAND-O....	For Basic IV CBM/PET, 39 functions with improved "Toolkit" commands	£59.95 + Vat
DISK-O-PRO....	For Basic II PET, adds 25 commands including Basic IV, in one 4K rom	£59.95 + Vat
KRAM.....	For any 32K PET/CBM for retrieving disk data by KEYED Random Access	£86.95 + Vat
SPACEMAKER IV	For any PET/CBM, mounts 1-4 roms in one rom slot, switch selection	£29.95 + Vat
" USER I/O	For software selection of up to 8 roms, in any two Spacemaker Quads	£12.95 + Vat
PRONTO-PET....	Soft/hard reset for 40-column PETs	£9.99 + Vat

SUPERKRAM, REQUEST & KRAM PLUS will be available shortly

We are sole UK Distributors for these products, which are available from your local CBM dealer, or direct from us by mail or telephone order. To order by cheque write to: Calco Software, FREEPOST, Kingston-upon-Thames, Surrey KT2 7ER (no stamp required). For same-day Access/Barclaycard service, telephone 01-546-7256. Official orders accepted from educational, government & local authority establishments

...at the best prices!

WORDPRO IV PLUS	RRP £395 less £98.75 = £296.25!
WORDPRO III PLUS	RRP £275 less £68.75 = £206.25!
WORDPRO II PLUS	RRP £125 less £31.25 = £93.75!
VISICALC	RRP £125 less £25.00 = £100.00!
TOOLKIT Basic IV	RRP £34 less £9.50 = £24.50!
TOOLKIT Basic II	RRP £29 less £7.25 = £21.75!

The items above are available by mail or telephone order at our Special Offer Price when purchased with any one of our software products. This offer is for a LIMITED PERIOD only. UK - ADD 15% VAT. OVERSEAS airmail postage - add £3.00 (Europe), £5.00 (outside Europe).

Calco Software

Lakeside House - Kingston Hill - Surrey - KT2 7QT Tel 01-546-7256

ACT SIRIUS 1

THE ACT SIRIUS 1
SPECIALISTS IN LONDON
CONCEPT COMPUTERS
01-729 1800



- * integrated accounting systems from COMPACT, TABS & ACT.
- * wordprocessing with WORDSTAR.
- * add MAILMERGE to Wordstar for mailing lists/mailshots.
- * spread sheet calculations with SUPERCALC.
- * advanced financial modelling with MICROMODELLER.
- * range of compilers, including new level II CIS COBOL, the full ANSI 74 standard COBOL.

For a demonstration at our showrooms or in your own office call Brian Chambers or Charles Orrrod on 01-729 1800.

CONCEPT HOUSE, 445 HACKNEY ROAD,
LONDON E2 9DY.

pearcom

The new, APPLE-II compatible Euro-PAL colour microcomputer now available

ex stock **£875**

excl. VAT

ALSO AVAILABLE: THE ASSEMBLED AND TESTED PEARCOM MOTHERBOARD WITH 48K RAM FOR £450, EXCL VAT

MAIN FEATURES:

Compact computer with the famous 6502 CPU, APPLE-II compatible, so one can use all the APPLE-II hardware and software without any modification.

Many interesting features give the PEARCOM an enormous technical lead.

Just to name a few:

- 14 I/O expansion slots as standard
- On board expandable to 96 Kbyte of RAM, 32K standard
- 6 ROM/EPROM sockets jumper adjustable.
- Professional reed-switch keyboard with numeric pad
- 7 Function keys
- Built-in HF modulator with HF PAL-colour output
- Sound through TV signal and through built-in loudspeaker
- LED indicators for the main-units
- An industrial type, 5 Amp. power-supply
- Bus compatible with the Applesoft Card and the Z80 Softcard from Microsoft, which comes with CP/M and Microsoft BASIC (optional)



PEARCOM Ltd.

Riverside 1a - Stanstead Abbots - Ware, Herts SG12 BAP - UK

PEARCOM International Marketing & Publicity Dept.
PO Box 350 - 3720 AH Bilthoven - Tlx 70375 - Holland

* Apple-II - Trademark of Apple Computer Inc. USA.

PEARCOM
Int. Marketing & Publicity
P.O. Box 350
3720 AH Bilthoven

● Circle No. 145

DEALER INQUIRES INVITED

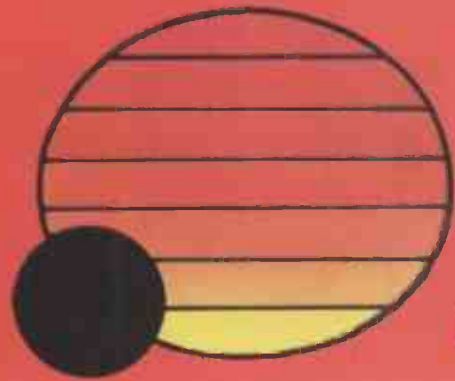

AS S

THE 16-BIT PERSONAL COMPUTER

The ACT Sirius 1 is more than the UK's best-selling 16-bit personal computer. It is the only one with such a large choice of 16-bit software — business and scientific programs specially developed to take advantage of the high speed 16-bit Intel 8088 microprocessor at the heart of every Sirius.

Combine this faster and more powerful software with the advanced specifications of the Sirius 1 and you can see why more and more business users are choosing Sirius.

Because Sirius users have both the latest microcomputer technology and the powerful 16-bit software that takes full advantage of it.

Ergonomics plays a vital part in the design of ACT's Sirius 1. The screen tilts and swivels to suit the user and glare is eliminated.

The display is razor sharp, and the brilliance and contrast can be adjusted using keys on the low profile detachable keyboard.

UP TO 896 KBYTES RAM

128 Kbytes of RAM memory as standard easily upgraded to a massive 896 Kbytes ensures plenty of capacity for fully fledged business software and associated record files.

Within the basic system is 1.2 Mbytes of floppy disk storage, with 2.4 Mbytes double sided disks available as an option. More than any other comparable personal computer.

As a result, the Sirius is suitable from the start for large record processing applications. And with 5 and 10 Mbyte Winchester disk drives scheduled for early introduction, the Sirius can easily match your own organisation's growth.

SOFTWARE THAT TALKS BACK

And built into every Sirius is a revolutionary new concept: An audio decoder that can play back verbal messages and prompts under program instruction to assist the non-computer people to get acquainted with the software more quickly.

NEW 16-BIT SOFTWARE

All the big names in applications software are on the Sirius: ACT's Pulsar for accounting, WordStar for word processing, MicroModeller for financial modelling and SuperCalc the "spread sheet" program.

Plus the exciting SELECT, the only word processor that teaches you how to use it in less than 90 minutes.

And more than 100 top software companies are currently developing specialist software for every business and profession from the motor trade to solicitors.



The ACT octagon encapsulates our philosophy of providing users with a single source for their computing solutions.

ACT products include personal computers — network micro-computer systems — turnkey mini computers and a total range of services, including software development, computer field engineering, computer supplies, and a complete range of Bureau services.

The eight specialist ACT companies are each leaders in their field and are wholly owned by Applied Computer Techniques (Holdings) p.l.c., one of Britain's largest and most successful computer companies.

See us at the
Personal Computer World Show
The Barbican 9-12 Sept. 1982.

ACT SIRIUS 1 PERSONAL COMPUTER Price £2,395



MORE LANGUAGES

The Sirius has more available programming languages than any newly-introduced personal computer. MicroSoft's BASIC 86, interpretative or compiled, CBASIC, a choice of several versions of COBOL, three different PASCAL's and a full scale FORTRAN.

The benefits? Programmers and software houses are making the Sirius their first choice computer for business software development.

Unlike other personal computers, the ACT Sirius 1 is delivered with the two industry standard operating systems at 16-bit level — MS-DOS and CP/M-86. Once again a guarantee now of the widest choice of off-the-shelf 16-bit software.

And further operating systems are under development. The much vaunted UNIX and a new system to support a low cost local area network.

COMMUNICATIONS

The Sirius is the ideal communications system, with two independent RS232 communications ports in addition to parallel and IEEE 488 ports. Available NOW are all the facilities required to communicate directly with large, mainframe computers.

Further backing is available by way of a dedicated Sirius Training Centre, run by ACT and open to all.

To support the product ACT has a truly professional network of systems dealers, hand picked for its knowledge of the business environment, enabling top quality support to always be close at hand.

ACT SIRIUS 1 — THE COMPLETE 16-bit personal computer.

To know more about the 16-bit ACT Sirius 1 and its exciting range of 16-bit software, clip the coupon and return it to: —

ACT (Sirius) Ltd.,
FREEPOST,
Halesowen, West Midlands,
• B63 1BR.

Or call for details now on
021-501 2284

Price excludes VAT.

I need to
know more about
the ACT Sirius 1 and the new
16-bit Software.

Name: _____

Position: _____

Company: _____

Address: _____

Telephone: _____

I may qualify for a dealership.
Please send a dealer
application pack

75

THE VERSATILE COMPUTER

with the features you need for
TODAY and TOMORROW

- *Z-80
(8 bit processor)
- *8088
(16 bit processor)
- *128K ram
- *8035 keyboard
processor
- *S-100 slots



- *Green phosphor
high resolution
screen
- *Integrated
floppy & winchester
disc drives
- *Detached
ergonomic
keyboard

The Vector 4 is an advanced 8/16 bit desk top computer.

It allows you to take advantage of the existing 8 bit CP/M programs while also providing 16 bit processing power.

The future is built into the Vector 4 with its Z-80 and 8088 processors,

128k of main memory (expandable to 256k), 3 S-100 expansion slots and standard software facilities with high resolution graphics that are second to none. Floppy disc and hard disc systems are available. Nationwide sales and servicing.

Let **ALMARC** show you
tomorrow's computers today.

Almarc

Almarc Data Systems Ltd,
Great Freeman Street,
Nottingham NG3 1FR.
Tel: (0602) 52657
Telex: 37407 Almarc/G

Almarc Data Systems Ltd,
Ward International Building,
Green Street,
High Wycombe,
Bucks. HP11 2RF.
Tel: (0494) 23804.

DATA SYSTEMS

FOR TOMORROW'S SYSTEMS TODAY

● Circle No. 147

Undue awe characterises attitudes towards programming for artificial intelligence, argues Mike Costello. Using the game of "eights" as an example he sets up a truly interactive game from a series of simple subroutines.

Basic steps towards intelligent programming

MANY MICRO OWNERS who are still feeling their way around Basic may think that the subject of artificial intelligence programming is altogether too esoteric for them. The logic of such programs must surely be very complex; they are usually written in assembly language and in any case they demand massive amounts of memory.

Although some AI programs conform to this description, the reality is that Basic is a suitable language for most AI applications. Memory capacity is not likely to be a handicap, and the logic of the programs is straightforward once the underlying principles are grasped. Everything depends on how you define artificial intelligence, of course, but a good working definition is a program which can carry out a "conversation" with a human player through the medium of a keyboard, giving intelligent responses to cues albeit within a strictly defined area of competence.

Chess problems

Much of the responsibility for the unnecessary awe in which AI programming is held can be attributed to the game of chess, or rather those who for many years now have been attempting to write chess-playing programs. The consensus is that chess is the most advanced of all games and that a program which simulates a human chess player will be the most convincing example of machine intelligence.

There is no agreed definition of intelligence, but it would generally be accepted that the complexity of chess lies in the need to look many moves ahead. Since there is only a negligible chance element in the game, and all the relevant circumstances which will affect both players are known to them in advance, the best chess program would have to look an infinite number of moves ahead. Clearly this is an impossibility, and more recent work in this area has concentrated on

working out general rules of strategy that the computer can apply in order to shorten its search through the enormous number of possible moves.

It is questionable whether this activity can teach anything about the nature of games in general. The number of games in which there is no chance element is actually quite small — you would have to exclude all card games, for example. Equally, there are very few games in which it is possible to look more than a few moves ahead. Many games involve an element of bluff, which means that the opponent's state of mind must be considered; and there will be occasions — during a Poker game, for example — when you may decide to play in a non-optimal way in order to deceive your opponent, for the sake of a gain to be made later.

Eights is an excellent little two-player card game played with a standard 52-card deck. The dealer gives seven cards to each player. The non-dealer can discard any card, and the dealer then has to play a card which is either of the same suit or the same denomination. The non-dealer then plays a card of the same suit or denomination as dealer's card, and so on.

Rules of the game

If a player does not have a playable card, he must draw from the pack until he finds a card he can play. He is not compelled to stop drawing as soon as he finds such a card, but the game is won by the player who gets rid of all his cards first. The winner scores for the cards in his opponent's hand, scoring most for cards of a high denomination. The only complication is that all 8s are wild: an 8

can always be played, and the player stipulates the suit of the card that must be played on to it.

Although the rules are so simple, there is a considerable amount of skill in eights. Making the machine play intelligently turned out to be rather more difficult than expected. In particular, it was hard to give the program enough flexibility in its strategy to cope with different human opponents using different kinds of strategy. The solution was to incorporate an element of "bluff": the machine had to confuse and, if possible, mislead the player as to the kind of cards it was currently holding in its hand.

String variables

The listings, which are in TRS-80 Basic, show the part of the program which enables the machine to play intelligently against a human. Listing 1 sets up the initial values and storage areas for data within the program. There are 300 bytes set aside for string storage, after which all variables beginning with letters from M to Z will be regarded as integers, and all the others are defined as string variables.

A large number of arrays are defined, since using arrays freely is one of the secrets of writing this sort of program — though it does presuppose that you have no problems with shortage of memory. The first three arrays are used only to shuffle the cards at the start of each game. Array P should be thought of as a sheet of paper, ruled with horizontal and vertical lines. This "sheet" contains 13 rows and four columns. It is used to hold the cards currently in the player's hand during the game, a number which can never exceed 52, the maximum capacity of the array.

The advantage of using a two-dimensional array with 52 elements is that the machine can figure out what kind of card is stored in a particular location in this array just by being told where it is. The columns correspond to suits, and the rows to denominations. Rows 0, 1, 2 and 3 hold clubs, diamonds, hearts and spades, respectively.

If the player decides to play the king of diamonds, for example, the machine should go to row 13, column 1 of the array. If a positive value is stored there, the machine knows that the player is

(continued on page 79)

Listing 1.

```
15 CLEAR 300: DEFSTR A-L: DEFINT M-Z
18
20 DIM M(51), MT(51), MM(100), P(12,3), T(12,3), Q(3), QS(3), QT(3), QD(3): RAND
UM: V5=1: S8=210: S7=274: RN=100: RM=51
54
```

Test-drive your software



You can buy software without trying it first...

The trouble is — sometimes it doesn't meet your particular needs.

— **And** it doesn't *always* live up to all of the advertising claims made for it.

— **And** often the write-ups you read about it (even in the best magazines), are just not *specific* enough.

— **And** even though your dealer *wants* to help, he's hard pushed to find the time for a full demonstration.

When it comes to purchasing software, the list of pitfalls is endless.

We have started the **Software Rental Bank** because we believe you should have the opportunity to evaluate software, on your own machine, with your own data, *before* committing yourself to a purchase.

And if you do decide to purchase — **the rental is free.**

I would like to receive the Software Rental Bank brochure.

Name _____

Organisation _____

Address _____

Tel: _____

Send to: The Software Rental Bank PC Aug 82

58 North Street, Leighton Buzzard, Beds. LU7 7EN

● Circle No. 149

OLIVETTI DAISY WHEEL ON LINE

From KRAM electronics, Victoria House,
17 Highcross Street, Leicester LE1 4PF
Telephone (0533) 27556

OLIVETTI PRAXIS 35 ON LINE DAISY WHEEL KEYBOARD PRINTER

- ★ Centronics standard interface
- ★ Friction feed
- ★ Correcting ribbon
- ★ Large selection of type faces
- ★ 12 characters per second

£399



LATEST SEIKOSHA GP 100A



£199

EPSON MX 80 F/T TYPE II



£359

KRAM ELECTRONICS

ORDERING

You may post your order with a cheque payable to KRAM electronics, or you may telephone your order day or night, any day, giving your ACCESS card number, a full description of the item and your name and address.

VAT

All the above prices exclude VAT. Please add VAT at the current rate.

CARRIAGE

Order over £100 ADD £6.
Orders over £10 ADD £3.
Orders under £10 ADD .50p

Post to: KRAM Electronics, FREEPOST, Leicester or Tel: (0533) 27556



GENIE II

INCLUDING *SOUND
*LOWER CASE *MODULATOR
*MACHINE CODE MONITOR

£299

WITH FREE CASSETTE DECK



CONTINUOUS PAPER

8" for GP80A
2000 sheets

£12

9 1/2" for EPSON
& GP100A
2000 sheets

£12

40 TRACK DISK DRIVES

The latest
OLIVETTI
Disk Drives

fully cased and
complete with
Toroidal power supply

DISK DRIVE Single drive £10
CABLES Dual drive £14

(Perhaps not the cheapest but we think these are the BEST!)

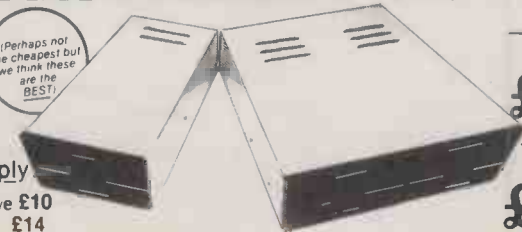

— SINGLE —

£179

— DUAL —

£349

● Circle No. 148

(continued from page 77)

actually holding that card, and the card can be played. The positive value is replaced with a zero, signifying that the player will be unable to play that card again.

Array T represents cards in the machine's hand. The Q series of arrays are used by the machine to work out the best card to play next, and can be a little confusing if the distinctions between them are not kept clear. Each array can hold values corresponding to the four suits, as follows:

Q holds the current total number of cards in the discard pile for each suit.

QS holds the current total number of cards in the machine's hand for each suit.

QT is used for temporary storage of the values from QS during computation.

QD locations will each always hold one or zero. For example, a one in location 0 means that the machine has a club of the same denomination as the card just played by the player; a zero would mean no such match. The machine uses this information when deciding whether it is best to play a card of the same suit as the card led, or whether it is better to switch suits.

Improving procedure

The Random statement in line 20 tells the machine to improve its procedure for choosing random numbers. Random numbers have to be picked out when shuffling the cards; a version of Basic with such a statement will, all things being equal, be better at picking genuinely random numbers than one without. The other variable values set in line 20 refer to screen locations for the Print@ statement, the shuffling routine and the tally of the number of hands played so far in the game, V5.

In the full listing for the game of eights, a few lines print an introductory title on the screen. They are followed by a routine to shuffle the deck before dealing the first hand, that is by loading array M with 52 specific values in a genuinely random order — listing 2.

Line 100 uses four-digit numbers to store both the suit and the denomination of cards in each location of the array; the ASCII values for S, H, D and C are 83, 72, 68 and 67, respectively. The idea is to get the first two digits of the four-digit number, and print the CHR\$ representation of them on the screen to show the suit. The final two digits, in the range 1 to D give the denomination.

Temporary array

Although this method works, it is not essential to store the information this way. Line 100 and the subroutine at 150 store the 52 values in a temporary array MT and then go into a loop which will "throw" the values into a larger, intermediate array MM at randomly chosen locations. Line 120 then picks the values out of MM one by one, and transfers them to the final array M from where

Listing 2.

```
60 CLS: PRINT@256, "A MOMENT WHILE I SHUFFLE ...":
80 '
100 X=0: Y2=6701: GOSUB 150: Y2=6801: GOSUB 150: Y2=7201: GOSUB 150: Y2=8301: G
GOSUB 150: FOR X=0 TO 51: Y5=MT(X)
105 '
110 Y6=RND(100): IF MM(Y6)=0 THEN 110 ELSE MM(Y6)=Y5
115 '
120 NEXT: Y6=0: FOR X=1 TO 100: IF MM(X)=0 THEN NEXT ELSE M(Y6)=MM(X): Y6=
Y6+1: NEXT
125 '
130 GOTO 200: REMARK: CONTROL PASSES TO RULES-DISPLAY ROUTINE
140 '
150 FOR Y=Y2 TO Y2+12: MT(X)=Y: X=X+1: NEXT: RETURN
```

they can be picked out as the machine "deals" cards.

Three arrays are used for shuffling. The problem in writing this routine is that it is really an inverse sort. There are plenty of routines to sort numbers in arrays, but routines to start with sorted numbers and mix them up are a rarity. You could dispense with the MM array altogether and transfer numbers from MT to M, but before putting a number in a randomly chosen location in M, the program must make a check that it has not already put one there. It tests for the presence of a value greater than zero in a location, and if it finds one, goes away and picks another at random.

Towards the end of the process, however, most of the array locations have been filled and the machine can spend an excessive time looking for a location that is still empty. The solution used was to transfer the numbers to MM, which has 201 locations, so that the machine would not waste much of its time addressing locations already filled — only about half the locations are filled at the end of the routine. The values are then moved from MM to the more compact M array one by one, ignoring the many zero locations in MM.

Dealing the cards

Once the 52 cards are sitting in M the first seven can be picked out and dealt to the player; the next seven are then picked out and given to the machine. On the TRS-80 display the machine's cards are shown as seven graphics blocks along the top of the screen, with more room for drawn cards later if necessary.

The player's cards are sorted into suits and then displayed in ascending numerical order, using an A to represent an ace, and so on. A little picture of the rest of the pack is drawn, showing an empty frame where the discards are going to appear.

It is worth noting that these routines took at least as long to write as the AI section of the coding. The program aims for maximum "user-friendliness", which is always desirable, but is also very time-consuming.

The method chosen for storing information makes it easy to write coding that will allow the machine to make intelligent decisions. Thus one major problem of AI programming has already been overcome, namely, how to translate the

information that the machine needs in order to make its decisions into numeric values which the machine can easily access.

The machine's decisions must now be broken down into a series of steps, each one of which can then be translated into one or two program lines. This part of the program can be drafted in advance using pseudo-code, which is an intermediate step between ordinary English and the Basic program listing itself, and the pseudo-code for the AI ingredient of the eights program is shown in figure 1. This is not necessarily the best way of preparing to write a program. Much depends on the working habits of the individual programmer, but it is worth considering as a way of preparing for the job of writing the coding itself.

Play routine

The pseudo-code assumes that when the routine is used by the machine, the human opponent has just played a card and the machine must decide what response to give. The first step is to check whether the machine has some card in another suit of the same denomination as the card just played. The denomination of that card is stored as the variable WD, varying from 1 to D. The machine also knows the array address of the player's card: WC corresponds to the column in the P array for cards of that suit, and PD corresponds to the row for that denomination.

The machine will make a special check to see if the card is an 8; if it is, there is no point in wasting time looking for cards in other suits since the player can dictate the suit that must be played on to an 8. Otherwise, look for matching denominations in other suits in order to establish the full range of cards held by the machine which could legally be played.

If the routine finds that the machine has a choice of suits, the next thing to do is to establish the longest such suit. The machine will always choose to play from its longest suit if possible since its opponent will probably have to respond with another card of the same suit.

It may be that the machine's preferred suit is the suit of the led card anyway, either because it is also the machine's longest suit or because it does not have any matching denominations. In that case all that remains is to pick the highest

(continued on next page)

(continued from previous page)

denomination in that suit, since the machine wants to get rid of high-value cards which would count in favour of a winning opponent. The machine always saves up 8s for emergencies.

The routine for finding the highest card in a given suit works by a For-Next loop which counts down through the array column backwards, jumping back to the main routine when it finds a positive value. The same routine can be used even if the machine turns out to have no cards in that suit; in that case, control returns from the routine with the counter variable set at -1.

If this has happened and the machine cannot switch to another suit it has to consider whether it has any 8s.

Otherwise it will have to draw a card, and control passes to the appropriate routine. If it does, it has to weigh up the advantages of playing the 8 on the one hand — getting rid of another card and being able to force the suit to be played on to it — and choosing to draw on the other hand, keeping the wild card for a rainy day.

This decision needs a separate routine, which checks things like how many cards the human player still holds and how many cards are left in the pack. If the machine decides to draw, it will be sent to the card-drawing routine with instructions to draw up to a specified number of cards. If it has not found a playable card by then it gives up and plays with its 8 anyway.

If the machine plays an 8, it still has to decide what suit to force to follow it, and the routine for this uses the "weighing factors" that are a feature of AI theory.

Figure 1. Intelligent elements of program for eights.

Denomination in WD. Address is P(PD,WC)

if the card is an 8, player has forced us to play a given suit (WC) so go straight to routine A

— else go through machine's cards noting any matching denoms

if none, go to routine A

— else find out how many cards in each eligible suit

— then select the longest suit

if longest eligible suit or only eligible suit is led suit we can play any denom, so pick highest non-8 and go to card-play routine

— else we can only play the one card, the matching denom, so go straight to card-play routine

ROUTINE A

looking for cards in a particular suit

if any, choose highest and go to card-play routine

— else have we got any 8s?

— if not go to card-draw routine

— else decide whether playing or drawing up to specified number of cards first

if playing, go to card-play routine

— else go to card-draw routine with specified number

CARD/PLAY ROUTINE

play the card: if it is an 8, note the suit we are forcing rather than the suit we are playing; print a special message if we are playing our last card and it is an 8; else note that it is the player's turn next, and return from the AI section of coding

Listing 3.

```
6000 PD=WD-1: IF WD=8 THEN 6400 ELSE FOR X=0 TO 3: QD(X)=0:NEXT X=0: FOR TC=0 TO
3: Y=T(PD,TC): IF Y>0 THEN QD(TC)=1: X=X+1:NEXT TC ELSE NEXT:REMARK:NOTE ANY MATCHI
NG DENOMINATIONS IN OTHER SUITS (UNLESS FOLLOWING 8, THEN ONLY WANT TO LOOK AT
THE FORCED SUIT)
6010 IF X=0 THEN 6400: REMARK: WE JUMP TO 6400 IF THE MACHINE CANNOT MATCH THE D
ENOMINATION OF THE CARD LED
6015 '
6020 GOSUB 7010: REMARK: ON RETURN FROM THIS SUBROUTINE WE HAVE STORED THE LENG
TH OF EACH SUIT HELD BY THE MACHINE IN THE ARRAY BS
6025 '
6030 FOR X=0 TO 3: IF QD(X)=0 AND X<>WC THEN BS(X)=0: NEXT ELSE NEXT: REMARK: TH
IS TELLS THE MACHINE TO IGNORE SUITS WITHOUT MATCHING DENOMINATIONS BY NULLING
THE VALUE IN BS
6035 '
6040 GOSUB 8600: REMARK: ON RETURN, X3 HAS A VALUE EQUAL TO THE COLUMN IN THE T
ARRAY FROM WHICH THE MACHINE WILL PLAY ITS CARD
6045 '
6050 IF X3=WC THEN 6100: REMARK: TESTING TO SEE IF THE MACHINE'S PREFERRED SUIT
IS THE SAME AS THE PLAYER'S LED SUIT
6055 '
6060 TC=X3: TR=PD: GOTO 8000: REMARK: MACHINE'S CHOSEN SUIT IS IN X3 AND THE DEN
OMINATION IS THE SAME AS THAT OF THE PLAYER'S CARD
6065 '
6100 GOSUB 7030 :TC=X3: TR=X: GOTO 8000: REMARK: ON RETURN FROM 7030 WE HAVE FOU
ND THE HIGHEST CARD (OTHER THAN AN 8) IN THE CORRECT SUIT. X3=THE SUIT AND X=
THE DENOMINATION
6395 '
6400 X3=WC: REMARK: WE DON'T HAVE THE SAME DENOMINATION IN ANOTHER SUIT, OR WE
ARE FOLLOWING AN 8 WHICH FORCES A PARTICULAR SUIT. LOOK FOR A CARD IN THAT SUIT
6405 '
6410 GOSUB 7030: REMARK: ON RETURN, X= THE HIGHEST CARD WHICH IS NOT AN 8
6415 '
6420 IF X=-1 THEN 6440: REMARK: WE HAVE NO CARDS IN THE LED OR FORCED SUIT EXCE
PT PERHAPS AN 8
6425 '
6430 TR=X: TC=WC: GOTO 8000: REMARK: PLAY THE CHOSEN CARD WHICH IS IN THE LED S
UIT
6435 '
6440 FOR X8=0 TO 3: IF T(7,X8)>0 THEN 6460 ELSE NEXT: REMARK: IF THE VALUE IS GR
EATER THAN ZERO WE HAVE AN 8 AND JUMP TO 6460
6445 '
6450 GOTO 7600: REMARK: WE CAN'T PLAY A CARD SO WILL HAVE TO DRAW ONE
6455 '
6460 U6=0: IF U=1 THEN TC=X8: TR=7: GOTO 8000 ELSE GOSUB 7300: XF=X3: GOSUB 6490
: IF U6=0 GOSUB 7400: TC=X8: TR=7: GOTO 8000 ELSE U5=X8: GOTO 7600
6465 '
6490 IF PU<4 RETURN ELSE IF Z>45 RETURN ELSE UB=INT(52-Z)/4:U7=0:U6=1: RETURN
```

The machine is looking for suits in which cards are scarce from the player's point of view but are plentiful in the machine's hand.

It therefore scores, say, 20 for a card of a particular suit in its hand, and also scores, say, 4 for a card of that suit in the discards, since that indicates that there

are fewer cards of that suit available to the player. After totting up the score for each suit, one suit emerges with the highest score, and that is the one to force.

The two weighting factors are different because holding a card of a suit is more important than knowing that the human opponent is unlikely to hold one; in practice, both values are likely to be altered during testing, to produce optimum play from the machine. A human player has much more trouble remembering the discards, of course, so the machine can be expected to be rather good at selecting just the right suit to force.

With this explanation in mind, the reader should be able to follow the actual program listing — listing 3. Lines 6020 and 6030 carry out the job of finding suits which have playable cards, either because they have matching denominations or correspond to the led suit. The specified number of cards the machine is prepared to draw before falling back on its 8 is calculated in line 6490, and so on. The plethora of GOSUB calls tidies away all the procedures the machine has to go through to achieve its results into separate chunks of coding, leaving the main routine from 6000 to 6490 showing the flow of logic summarised in the p-code.

The subroutines themselves are shown in listing 4. The card-draw routine loops around indefinitely looking for a playable card, but always checking that it has not reached the end of the deck, Z = 52, and that the number of cards it is allowed to

(continued on page 83)

When you outgrow your personal computer that's the time you'll wish you'd bought a DAI.

Very low priced personal computers can leave you feeling very low, after the initial novelty has worn off. Having learned what the computer can do, you then find out what it can't do. Unless you expand the system. And that can set you back a few hundred pounds for items such as extra RAM and serial interface. In fact, more than you paid in the first place! So when you've done all the sums, you'll realise that the DAI personal computer offers incredibly good value for money. Just look what you get for the all-in price.

1. 48K RAM.
2. 24K ROM-based software that includes a fast BASIC interpreter, scrolling screen editor, machine code utility program, twin cassette tape handling, and disc support.
3. A full duplex RS232 serial interface allowing direct connection of a printer (with resident software support) and other peripherals.
4. A parallel interface for connection of the CP/M compatible DAI disc unit and other user devices.
5. Superb 16-colour high resolution graphics (256 x 336).

6. Sound commands for music generation.
7. Standard TV interface via aerial socket.

These standard features pave the way for a whole new vista of personal computing possibilities. Find out more by completing the coupon today. Large range of "Dainasoft" software available, e.g. viewdata, word processing, educational, games . . .

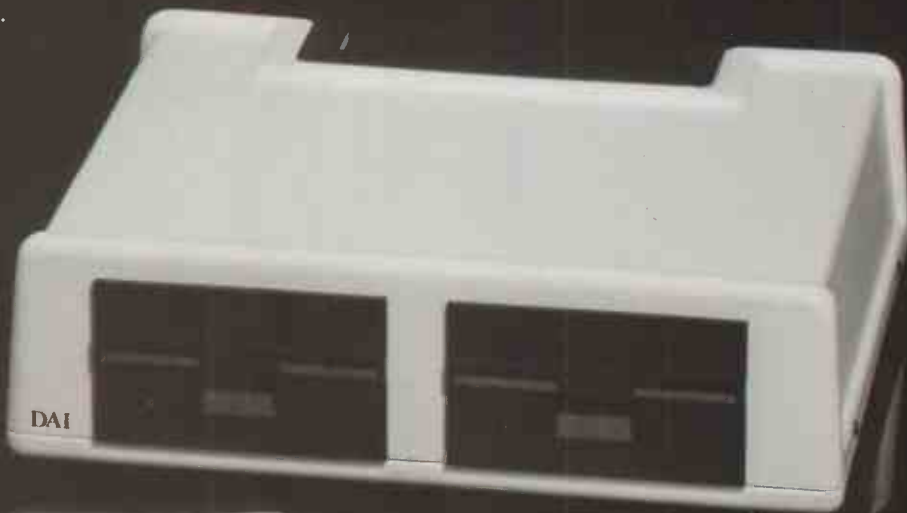

only £595.00
+ VAT
Disc unit extra

**Data Applications
(UK) Ltd.**

a DAI sets you up for life

DAI

16B DYER STREET, CIRENCESTER,
GLOUCESTERSHIRE GL7 2PF
TELEPHONE:
CIRENCESTER (0285) 61828 or 2588
TELEX: 43605 BECHAM G

Please send me further details about the DAI Personal Computer.
My interest areas are

Please send me a list of dealers

NAME:

ADDRESS:

TEL. NO.: 81

Send to DAI, 16B Dyer Street, Cirencester, Glos. GL7 2PF

● Circle No. 150

OPEN FOR BUSINESS.



The complete multi-purpose, multi-terminal desktop computer system for business.

Now you can get the world's most powerful, reliable, easy-to-use, multi-user microcomputer system at an affordable price. The ALTOS® Series 5-5D computer (including 5 MByte Winchester hard disk and the MP/M II™ operating system)*, which will support up to three smart terminals and a printer, for only £4440.

Our new Altos smart terminals function as independent work stations. Whilst your bookkeeper prepares payroll, other users can be checking inventory, computing cost estimates, doing word processing and performing hundreds of other business operations.

We can provide all the system software you need, too. Because we support hundreds of CP/M®, MP/M II and OASIS applications programs for Altos computers.

You can also add software that allows you to communicate with other computers and networks.

Thousands of business users throughout the world have improved their productivity with Altos computer systems. For more information, call or write today: Altos Computer Systems, Index House, Ascot, Royal Berkshire, UNITED KINGDOM SL5 7EU. Telex 849426.

Please ring operator for free phone 3003 (24 hours), or ring direct on ASCOT (0990) 26824.



COMPUTER SYSTEMS

**Packed with
fresh ideas
for business.**

*Series 5-5D includes Z80A processor, 192KB of RAM, one 1MB minifloppy and one 5MB micro-Winchester. Series 5-15D includes Z80A processor, 192KB of RAM, and two 1MB minifloppies for £2200. ALTOS is a registered trademark of Altos Computer Systems. CP/M is a registered trademark and MP/M II is a trademark of Digital Research, Inc. OASIS is a product of Phase One Systems, Inc. Z80 is a trademark of Zilog, Inc. © 1982 Altos Computer Systems

(continued from page 80)

draw, U7, has not reached the maximum. U8.

The program makes its decisions so fast that delay loops must be inserted into the program. Otherwise the player becomes bewildered by the screen display, which shows drawn cards appearing in the machine's hand, the machine's comments as it is playing, and so on.

When testing the program I generally played the machine to a draw, yet another player managed to beat it every time. At this stage the program did not include the routines which allow the machine to hold on to an 8 and draw from the pack instead of using the 8 up. I generally played an 8 rather than drawing, and I had unwittingly designed this thing in my own image, giving it my own strategy which turned out not to be the best.

The missing routines were therefore added, and the program is now much

better able to cope with different play strategies from different human opponents, although of course it does not actually learn from experience. The effect of these routines is to make it much more difficult for the human player to guess what the machine holds in its hand, as the signals given by the machine concerning cards played and number of cards drawn are now often misleading.

There should be little difficulty in adapting the listings here for other dialects of Basic, such as the 8K ZX-81. One obvious point is that arrays start from 1 not 0 on the ZX-81, so you will need to store denominations in rows 1 to D rather than 0 to C. This actually makes the coding much easier because, for example, the denomination, WD, can also be used for the array address, PD, rather than always having to subtract 1. Local variable types may have to be used if there is no type declaration facility but as a bonus full-length variable names can

Arrays, string storage, variable storage,	
run-time allocation	1,600 bytes
Titles and rules text	4,300 bytes
Screen formatting	1,300 bytes
Handling user-input	
and user-proofing	1,600 bytes
A.I.	2,300 bytes
End-of-hand and	
end-of-game routines	1,100 bytes
Subroutines common to	
several areas of the coding	1,100 bytes
Total	about 13,300 bytes

Memory requirements of eights program.

be employed, making it much easier to trace the flow of the program from the actual listing.

Multi-statement lines will, of course, have to be broken up into separate lines, although you may be able to acquire a machine-code utility that allows multi-statement lines, which certainly speeds things up. You do have to be careful when dealing with long lines involving the Else statement, not available in all Basics.

Line 6460 sends control in one of a number of different directions, depending on what conditions are fulfilled. It can be rewritten as single-statement lines, each of which repeats the same test. It cannot be assumed, however, that all possible conditions are covered in a line of this structure. There may be a default condition dealt with in the next line, and control drops through to it if none of the Else-If conditions are met.

Apart from this, the statements used in the program should correspond to statements available in the Basics of most popular models of microcomputer. The Radio Shack Basic which Microsoft wrote for the TRS-80 four years or so ago was one of its earliest and most thorough attempts, and most of the Basics that have become available since then are subset of this original version. It is a different story with hardware-dependent features like screen formatting statements which vary from one model to another.

Finally, some Basics are more lax about details than others. For example, the ZX-81 insists on the use of Let in assignment statements, and lines like

```
IF X=1 THEN 3000
```

should be rewritten

```
IF X=1 THEN GOTO 3000
```

Users of non-Microsoft Basics like the Atom are probably already used to translating program listings into their own dialect. Whatever hardware you are using it would be wise to make a preliminary estimate of the memory consumption of the whole program, which is considerably more than that required for the AI routines themselves.

A tape of the complete program is available from Entersoft, PO Box 22, Droitwich, Worcestershire, WR9 9HJ. It is currently available in a TRS-80 version, and is being rewritten for the ZX-81. □

Listing 4.

```
6499 REMARK: ROUTINE TO BUILD UP VALUES IN QS
7000 GOSUB 7010: GOSUB 8600: GOSUB 7030: GOSUB 7050: TR=X: TC=X3: RETURN
7005
7010 FOR X=0 TO 3: QS(X)=0: NEXT: FOR TC=0 TO 3: FOR TR=0 TO 12: IF TR=7 THEN 702
0 ELSE IF T(TR,TC)=0 GOSUB 7025
7020 NEXT: NEXT: RETURN
7025 QS(TC)=QS(TC)+1: RETURN
7029 REMARK: ROUTINE TO FIND HIGHEST CARD
7030 FOR X=12 TO 0 STEP-1: IF X=7 THEN 7040 ELSE IF T(X,X3)=0 THEN RETURN
7040 NEXT: RETURN
7049 REMARK: ROUTINE TO DISPLAY PLAYED CARD (CALLED BY LINE 8000)
7050 Q(X3)=Q(X3)+1: XL=T(X,X3): T(X,X3)=0: Y=XL: GOSUB 2550: PRINT@8," "; PRI
NT@8, CHR*(W5):: Y5=WD: GOSUB 2300:PRINT@8," "; PRINT@87,F:: RETURN
7299 REMARK: ROUTINE TO WEIGHT SUIT VALUES
7300 FOR ZZ=0 TO 3: QS(ZZ)=0: NEXT: FOR ZZ=0 TO 3: FOR ZY=0 TO 12: GOSUB 7350:
NEXT: NEXT: VS=(Q(0)*5)+(QS(0)*20): VH=(Q(1)*5)+(QS(1)*20): VD=(Q(2)*5)+(QS(2)*
20): VC=(Q(3)*5)+(QS(3)*20)
7305 IF QS(0)=0 THEN VS=0
7306 IF QS(1)=0 THEN VH=0
7307 IF QS(2)=0 THEN VD=0
7308 IF QS(3)=0 THEN VC=0
7309 REMARK: DON'T FORCE A SUIT MACHINE IS VOID IN, WHATEVER THEWEIGHTING FACTOR
S SAY
7310 QS(0)=VS: QS(1)=VH: QS(2)=VD: QS(3)=VC
7320 GOSUB 8600: REMARK: COME BACK WITH THE CORRECT SUIT TO FORCE = X3
7330 RETURN
7350 IF ZY=7 OR T(ZY,ZZ)=0 RETURN ELSE QS(ZZ)=QS(ZZ)+1: RETURN
7399 REMARK: ROUTINE TO PLAY AN 8
7400 IF U=1 THEN PRINT@884,"I'M AFRAID MY LAST CARD'S AN 8":RETURN ELSE IF X3=0
THEN J=C5 ELSE IF X3=1 THEN J=C6 ELSE IF X3=2 THEN J=C7 ELSE J=C8
7410 PRINT@884, "I'M GOING TO PLAY AN 8 - YOU WILL HAVE TO PLAY "J": PRINT@892,
CHR*(30):: PRINT@896,"NOTE THIS SUIT, THEN PRESS ANY KEY": PRINT@960, CHR*(30)::
GOSUB 16000: PRINT@884, CHR*(216):: PRINT@896,CHR*(30)::PRINT@960,C9: RETURN
7599 REMARK: ROUTINE TO DRAW CARDS UNTIL PLAYABLE CARD FOUND OR OTHER CONDITIONS
MET
7600 IF Z=52 GOTO 8500 ELSE PRINT@884,"": GOSUB 7700: GOSUB16100: Y=M(Z): Z=Z+
1: U7=U7+1: GOSUB 2550: PRINT@884,CHR*(30)::IF Z=47 GOSUB 26000 ELSE IF Z=52GOS
UB 10500: REMARK: AT THIS POINT WD=DENOM. AND WS=SUIT
7610 GOSUB 2600: REMARK: TC NOW HAS VALUE FROM 0 TO 3
7620 T(WD-1,TC)=Y: U=U+1: GOSUB 2100: REMARK: DRAWN CARD HAS BEEN STORED IN MACH
INE'S HAND
7630 IF WD=8 OR WD=1=PD OR TC=WC THEN 7650: REMARK: 7650 IF IT CAN BE USED AS D
ISCARD
7640 IF U6=0 THEN 7600 ELSE IF U7=UB THEN 7600 ELSE X3=XF: GOSUB 7400: TC=U5: T
R=7: GOTO 8000
7650 IF WD=8 THEN XT=X: TT=TC: GOSUB 7010: X=XT: TC=TT: GOSUB 7300: XF=X3: GOSUB
7400: TR=7: GOTO 8000 ELSE TR=WD-1: GOTO 8000: REMARK: NOTE THE SUIT THE MACHINE
IS FORCING IF PLAYING AN 8, ELSE JUST PLAY IT
7990 REM*****
7995 REMARK: ROUTINES IN LISTING 3 JUMP HERE
8000 PRINT@884, "HERE'S MY DISCARD ....": GOSUB 16100: PRINT@884, CHR*(216):: S
4=0: R6=0
8010 U6=0: X=TR: X3=TC: GOSUB 7050: U=U-1: GOSUB 2100: R=0: IF TR=7 AND U=0 THEN
PRINT@884, "I WIN WITH AN 8! ": GOSUB 16200: RETURN ELSE IF TR=7 THEN TC=X
F: RETURN ELSE RETURN
8011 REM*****
8499 REMARK: ROUTINE CALLED WHEN MACHINE CAN'T PLAY ONE AND PACK IS EMPTY
8500 R6=R6+1: IF R6=2 THEN 19900 ELSE PRINT@884,"I CAN'T GO: YOU TRY TO PLAY ONE
": GOSUB 16100: GOSUB 16100: PRINT@884,CHR*(30):: R=0: TR=PD: TC=WC: RETURN
8599 REMARK: ROUTINE TO FIND SUIT WITH MOST CARDS IN AND STORE ITS ARRAY COLUMN
IN X3
8600 IF QS(0)=QS(1) THEN X1=0 ELSE X1=1
8610 IF QS(X1)=QS(2) THEN X2=X1ELSE X2=2
8620 IF QS(X2)=QS(3) THEN X3=X2ELSE X3=3
8630 RETURN
```

COMPUTECH for Apple

Authorised dealer, service centre and system consultancy

SUCCESS BREEDS SUCCESS!

As authorised dealer and service centre for Apple computers we have acquired extensive experience of users' needs and the most cost effective means of satisfying them from the considerable resources of this popular and reliable machine. Over 1,000 of our financial accounting packages have been installed. In the process we have detected areas of special need and opportunities for enhancing these resources. Our own manufactured hardware and system software have been produced to meet these requirements. As a result we have compatible products for all configurations of Apple II and ITT 2020 installations - and the new Apple /// !

Apple /// now on demonstration - systems from	£1,645
Pro-File 5 MB mass storage for Apple ///	£2,256
Computech mass storage for Apple II and Apple ///, up to 12 MB, from	£1,950

COMPUTECH SOFTWARE AND HARDWARE INCLUDES:

Payroll for 350 employees, 100 departments, all pay periods, printed payslips, approved year end documents, very quick and easy to use, **£375**. **Sales, Purchases** and **General Ledgers** **£295** each, detailed statements. **Job Costing** and **Group Consolidation** are amongst many and various applications of the **General Ledger** package, which supports values to totals of one thousand million accurate to a penny! Our **Utilities Disk** available like other packages in 13 sector or 16 sector format, is widely used for reliable, error checking, copying, including single drive, and the renowned **DPATCH** program beloved of programmers for **£20**. We have developed a **Terminal Utilities** package which enables Apple to Apple and Apple to mainframe communications with local processing and storage as well as Apple to host communications from the amazingly low price of **£130**. Our **Graphics Utilities** program for use with the **Microline** and **Epson** families of printers enable the plain paper production on low cost printers of high resolution screen pictures, graphs etc. - free with **Microlines** or **£30** separately. **Keyboard Driver** enables the use of our **Lower Case** adaptor with BASIC programs and **Applewriter Patches** supplied **FREE** with our character generator package (total cost **£50**) is separately available on disk with documents for **£10**. At the same price **CAI** (convert Apple pictures for ITT) makes binary high resolution picture files display properly on the ITT 2020. We sell the famous **Visicalc** for **£130** and have delivered systems using it to do amazing things like production control, shipping accounts and stocks and shares valuations! The versatile **Applewriter** word-processing package at only **£39**, especially employed with our **Lower Case Character Generator** is widely used by people who cannot type to produce word-perfect copy! Experience with Apple systems has led to the design and manufacture of compatible products with enhanced features at very favourable prices to satisfy users' needs. These include the **Diplomat Serial Interface** which has handshaking capability and switchable options (**£80**), the **Diplomat Parallel Interface** which enables the direct use of text and graphics with the **Microline** and **Epson** printers and is a complete 'plug in and go' item with gold-plated edge-connector at **£80** and has optional direct connection for **Centronics 730/737** printers. Our new **Diplomat Communications Card** at **£95** is a sophisticated peripheral especially suitable for Apple to mainframe communications at high speeds in full duplex mode with switch selectable bit rates and other options. The **Lower Case** adaptor is available for Apples (revision 7 and earlier) as well as ITT 2020, complete with diskette software for **£50**. It offers true descenders on screen and the £ sign. We also have an **Optional Character Generator** for the ever popular **Microline M80** at **£15**. This provides £ sign and improved digits and lower case characters with USASCII special symbols. Our price for the **Microline M80**, with graphics, 40, 80 and 132 characters per line, friction, sprocket and teleprinter feed, is only **£295**, amazing for this small, quiet reliable 'look alike' printer. Tractor option is **£40** and **Serial Adaptor** **£80**. The **Microline M82A**, bidirectional printer with both parallel and serial input is only **£395**, it can have an optical 2K buffer, while the **Microline M83A** full width adjustable tractor 120 cps printer with similar specification is only **£645**. Then for all computer users there is the unique **Micromux** which from **£800** provides up to 16 ports for simultaneous independent serial asynchronous communications! Telephone for data sheets or to arrange a demonstration or for the address of our nearest dealer. Please hurry - the demand for our products has been such that some have been temporarily out of stock. We offer the effective low cost solutions you need. **Prices exclude V.A.T., carriage and packing.**

COMPUTECH SYSTEMS

168, Finchley Road, London NW3 6HP. Tel: 01-794 0202

AGENTS THROUGHOUT THE UK AND OVERSEAS

Morse code translated using pattern recognition

THE RADIO AMATEUR, unlike computer hobbyists, has one or two hurdles to straddle before being permitted to engage in this pursuit. Although anyone may receive broadcasts on the amateur bands, an amateur licence must be obtained in order to transmit. There are two classes of amateur licence. The class B licence is available only to those who have learned sufficient about the hobby to pass a multiple-choice examination held by the City and Guilds of London Institute. With such a licence the amateur may transmit speech on the 144MHz amateur band or higher-frequency amateur bands.

Restriction to these bands effectively rules out long-range intercontinental contacts, commonly known as DXing. To operate on the lower-frequency amateur bands where DX contacts are more common a class A licence must be obtained and in order to do so the amateur must have passed the Home Office test in morse.

Send and receive

In the test, 36 words averaging five letters per word must be sent, and 36 words received in two periods of three minutes each. Up to four errors are permitted in the copy received and up to four corrections may be made while sending; there must be no uncorrected errors in sending. In addition, 10 groups of five figures must be sent and 10 groups copied in two periods of 1.5 minutes each. A maximum of two receiving errors is permitted in this section, and up to two corrections made while sending.

Many amateurs refuse or fall at this hurdle who are determined to gain access to the more interesting amateur bands. Others are prepared to expend vast amounts of time and money attempting to learn the code to the required level of proficiency.

Morse tutors have been available commercially for many years, and include simple records of morse code which the learner plays first at, say, 33rpm, and later at say 45rpm. Besides having to cope with the resulting change in pitch, the learner may be learning the particular messages on the record rather than the code itself.

Recently, dedicated electronic devices have been built to generate bursts of random morse for the learner to decode. Since the characters generated are not

Christopher Dracup and Derek Wakelin show how a microcomputer program can encode and decode morse, and act as a morse code tutor. The basic rule is that a Dah or dash should be three times the length of a Dit or dot.

displayed, it is not possible to check the accuracy of the learner's performance. Microcomputer programs have been written to replace these tutors but are little more than replicas of the commercial morse tutors.

All these have certain limitations:

- They are generated without any knowledge of human learning and hence cannot claim to be designed to maximise learning. In particular they disregard the importance of feedback.
- They do not give the learners an opportunity to create their own morse and have it decoded in order to check that recognisable morse is being produced.

This program attempts to overcome these limitations. In it the learner has a choice of four options, to be selected depending on skill and whether morse is to be encoded or decoded.

Learning mode

Option 1 is used for learning the code. The learner presses the key of any letter or number, and the machine produces the appropriate morse. The program uses the Get command of the Pet, allowing the learner to enter characters into the input buffer ahead of the morse produced. Words are separated by using the space bar.

A friend with no knowledge of morse could help the learner by typing in a message on the keyboard. The Pet converts it into morse and the learner can try to decode it. All letters are displayed on the screen so that the subject can check performance later. This part of the program could be made to operate a relay actually keying a transmitter, thus allowing even a relatively inexperienced class A licence holder to be certain of sending good morse.

In option 2, which is designed to improve speed, the machine produces

morse code corresponding to a randomly selected letter and waits for the learner to press the appropriate key on the Pet. After a key is pressed, the correct letter is displayed on the screen. If the correct key is pressed within a preselected time the machine confirms the choice and the probability of the machine presenting this character in future is decreased.

If the correct key is pressed, but after the time limit has elapsed, the machine informs the learner that the response was too slow and makes no change to the probability of the character appearing again. If the learner does not correctly identify the morse and a wrong key is pressed then the morse code is presented again and the learner is required to enter the correct letter, which is displayed on the screen. The probability that the machine will present a wrongly identified character in the future is increased.

Problems identified

The time allowed to respond is determined by the learner at the beginning of each run and may be reduced as proficiency increases.

Pressing the # key at any point displays the probability associated with each letter. Higher values indicate those letters with which the learner has had problems, whereas lower values indicate those letters which the learner identified more readily. This option allows the presentation of numbers rather than letters.

Option 3 is a morse test simulator which allows the learner to decode random morse at speeds specified in the Home Office test, or at other speeds determined by the user. One difference between the program and the Home Office test is that random letters are produced rather than plain language. Plain language contains a certain amount of redundancy, so missed letters can often be guessed correctly by the context. This is not so with groups of random letters, and anyone capable of decoding random letters at 12 words per minute can be quite confident of being able to decode plain language at the same rate.

The characters are printed on the screen while the morse is presented, giving a major advantage over conventional random morse generators. The display allows the learner to check the accuracy of decoding. The program also allows the learner to have longer spaces between

(continued on next page)

First symbol	If Dit	$1 \times 2 \uparrow 0 = 1$
	If Dah	$2 \times 2 \uparrow 0 = 2$
plus		
Second symbol	If Dit	$1 \times 2 \uparrow 1 = 2$
	If Dah	$2 \times 2 \uparrow 1 = 4$
plus		
Third symbol	If Dit	$1 \times 2 \uparrow 2 = 4$
	If Dah	$2 \times 2 \uparrow 2 = 8$
plus		
Fourth symbol	If Dit	$1 \times 2 \uparrow 3 = 8$
	If Dah	$2 \times 2 \uparrow 3 = 16$
total gives characteristic value of character C.		
This can be expressed by the equation:		
$C = \sum c_i \times 2^{(i-1)}$		
where $c_i = 1$, if the symbol is Dit		
$c_i = 2$, if the symbol is Dah		
For example, the value for F is		
$1 \times 2 \uparrow 0 + 1 \times 2 \uparrow 1 + 2 \times 2 \uparrow 2 + 1 \times 2 \uparrow 3 = 19$		

Figure 1.

(continued from previous page)

characters without slowing down the characters themselves. A learner wishing to test his ability at decoding plain language can use option 1.

Option 4 decodes correctly sent morse, and will test the learner's ability to produce morse. The letters or numbers that the Pet identifies are displayed on the screen, allowing feedback on the accuracy of timing when sending morse.

A Dah or dash should be three times the length of a Dit or dot, and the time interval between Dits and Dahs in a character should be of one Dit duration. The time between two characters in the same word should be three Dits long, and the interval between words five Dits.

The program works on the basis of these rules, which represents ideal morse, but does allow a degree of error during input. The program can estimate the speed of a learner's morse by averaging the result of three Vs. Alternatively the speed can be entered directly if it is known.

While devising the program, all the problems encountered by researchers in artificial intelligence were encountered, including representation, constraints, searches, etc. The precise method of overcoming them varied, but usually included a large dose of serendipity. This fairly straightforward program should demonstrate to amateurs and hobbyists that they are dealing with exactly the same difficulties that besige researchers on sophisticated programs that understand language, or read handwriting.

It was intended to make the program easy to transfer from one machine to another, so Basic was used rather than machine code. One problem was whether an interactive non-compiled language like Basic would be able to work fast

enough. Although the program is written for an 8K Pet, parts of it have run successfully on an Exidy Sorcerer and on a 1K ZX-81.

One of the obstacles encountered in work in artificial intelligence is the way knowledge should be represented, but representing morse code turned out to be fairly straightforward. Characters are conveyed in morse as a series of short and long pulses — Dits and Dahs — separated by pauses. In the program Dits are represented by the letter S, and Dahs by the letter L.

Array storage

The morse corresponding to each character is stored as an element in an array M\$. The morse code for the letter A is —, and is stored in M\$(1) as SL. Morse for a character is generated by the subroutine located at lines 300 to 380 and 400 to 440. S and L determine the duration of tones by controlling the number of iterations of a For loop. The duration for L is three times that for S — see lines 320 and 330.

The number of Dits and Dahs in the character is calculated in line 310. The tone is turned on at line 410, is presented by line 420 for the appropriate duration, and switched off at line 430. Line 350 presents the appropriate pause between successive Dits or Dahs within a character; line 370 presents the appropriate pause between characters in the same word; and lines 3200 and 1050 give the appropriate pause between words.

Anyone who has heard morse transmitted on the amateur bands will realise the tremendous range of speeds at which code is sent and must be received. It is, therefore, important for learners to be able to listen to morse at different speeds, and in particular to be able to operate comfortably at the speed specified by the Home Office test.

Adequate fit

An empirical approach to this problem resulted in the following:

$$DL = \text{INT}(\text{EXP}(5.28 - .21 * \text{NL})) * (3.0148 - \text{LOG}(S))$$

where

- DL represents the number of iterations required to produce a Dit,
- NL represents the number of letters per word,
- S represents the required speed in words per minute.

This gives an acceptable fit, especially for speeds around 12 five-letter words per minute on the 8K Pet.

It is unlikely that this formula will work on other machines, highlighting the disadvantage of using an empirical method. However the calculation of a general solution based on the time for the machine to carry out particular instructions in Basic would have hardly justified the effort expended in calculating it. The formula is implemented at lines 1020 to 1024, 2020 to 2024 and 3030 to 3034.

Once the learner has become familiar with the code by using option 1, the next goal will be to speed up the process of recognition. Typically a learner recognises some characters almost immediately but will take quite a while to recognise others. A competent morse operator needs to recognise all the characters in the code immediately and automatically, and those characters with which the novice is experiencing difficulty must be identified in order to provide extensive practice on them. To provide this facility, option 2 alters the probability that a character will be presented in the future on the basis of the accuracy and speed of the learner's response.

The program starts by creating an array D, each element of which corresponds to a particular letter or number. In line 40 initially all the elements are set equal to one. Each character has the same probability of selection. Adjustments to the values associated with the characters are made in lines 2320 to 2400.

Line 2320 reduces the value of a character by a quarter when a correct identification within the time limit is made. Line 2340 increases such a value by a half when an incorrect identification is made. In order to prevent values becoming unworkably large or small, line 2270 is provided to rescale all values after each alteration. Lines 2312 to 2318 display the

Symbols used in the program.	
B\$	— characters in correct position for computer analysed morse
C	— position of character in M\$
CS	— character space
D(43)	— values associated with probability of presenting morse
DIT	— Dit length when computer analysing morse
DL	— Dit length for generated morse
DT	— scaling factor used in option 3
DU	— counter to measure speed of response
GR	— parameter in determining speed of output, gradient
IC	— parameter in determining speed of output, intercept
L5	— length of vocab: 10 for numbers, 26 for letters
M\$(43)	— morse codes for generating morse
MAX	— delay factor
NL	— number of letters per word
NS	— timer for pause length when analysing morse
S	— number of five-letter words per minute
SI	— timer for tone length when analysing morse
SL	— slowing factor, between characters
SY	— type of vocab, numbers or letters
V(15)	— used to calculate Dit length when analysing morse
W(15)	— used to calculate pause length when analysing morse
Z\$(64)	— list of characters in correct position when analysing morse
T1, I2, I, A\$, K, J and T	are all working variables

probabilities associated with each character whenever the # key is pressed.

In order to analyse morse that an operator is sending, it is necessary to be able to recognise the difference between a Dit and Dah. In addition, it is necessary to distinguish between the pauses signifying the end of a character, those signifying the end of a word and those pauses that occur within a character. A machine which is to decode morse must, therefore, measure the duration of Dits, Dahs and pauses.

Real-time decisions

After determining that a character has been sent, the Pet must decide on the nature of the character. The program measures durations in real time in Basic, without the use of hardware clocks, and makes use of constraints within morse code to identify characters.

Measurement of the duration of pauses, Dits and Dahs is achieved by the use of If statements. The state of the input ports is examined, and while a particular state remains a count is implemented. For example, in line 4130, Peek (59471) checks the input port. While the morse key remains pressed to produce a tone, the counter, SI, is incremented. Line 4320 does an equivalent operation except, in this case, NS is incremented during a pause, that is while the morse key does not make contact.

Checks can then be made to ascertain whether the counters exceed a critical length. For example, in lines 4410 and 4420 a decision is made as to whether a Dit has been broadcast or a Dah by comparing the size of SI with "Dit". In line 4450 a decision is taken as to whether the pause is long enough to indicate the end of a character. Line 4330 calculates whether the end of a word has been reached.

Counting loops

All of these decisions make use of the fact that the number of iterations of an If statement that equate with a duration of one Dit is known. The program then becomes straightforward, line 4050 allowing the operator to specify a Dit length.

More usually, the speed at which an operator produces morse is not known. An option is available, however, which will calculate an operator's Dit length. This is done at line 4060, which asks the operator to enter a sample of his morse, and then applies the procedure using If statements, saving the duration of key contacts and releases in the arrays V and W. The result of several key presses are averaged to provide a cut-off.

Although it might appear that the operator has to enter extremely accurately times morse for it to be recognised by the machine, this is not the case. Any key press that is longer than the critical length is assumed to be a Dit, and any

(continued on page 89)

```

4 REM MORSE PROGRAM
5 REM PROGRAMME DEVISED THROUGH THE
6 REM COLLABORATIVE EFFORTS OF
7 REM CHRIS DRACUP & DEKEL WAKELIN
11 DIM M$(43),D(43)
12 DIM T$(64),V(15),N(15)
13 B$="ETINAMSDRGUKJQHBLZFCPQXV?0?YI256?7??6??7??7??94?0??7?3??2?10??"
14 FOR I=1 TO 64: Z$(I)=MID$(B$,I,1):NEXT
20 POKE 950,0:POKE 951,54:SYS 845
30 POKE 950,7:POKE 951,56:SYS 845
40 FOR I=1 TO 43: READ M$(I):NEXT
50 FOR I=1 TO 43: D(I)=1:NEXT I
100 PRINT "J"
110 PRINT "MORSE TUTOR":PRINT
115 PRINT "
120 PRINT "THE FOLLOWING OPTIONS ARE AVAILABLE"
130 PRINT "
145 PRINT "COMPUTER GENERATED MORSE"
146 PRINT "
150 PRINT "1. LEARNING THE CODE - SINGLE LETTERS"
160 PRINT "2. IMPROVING SPEED"
170 PRINT "3. MORSE TEST SIMULATOR - RANDOM WORDS"
180 PRINT "PRINT"COMPUTER ANALYSED MORSE"
182 PRINT "
190 PRINT "4. LEARNING TO TRANSMIT"
200 PRINT "PRINT"PRINT"ENTER NUMBER OF SELECTED OPTION"
220 GET A$: IF A$="" THEN 220
230 ON (ASC(A$)-48) GOSUB 1000,2000,3000,4000
240 GOTO 100
300 REM SUBROUTINE TO GENERATE MORSE
310 FOR J=1 TO LEN(M$(C))
320 IF MID$(M$(C),J,1)="S" THEN T=DL
330 IF MID$(M$(C),J,1)="L" THEN T=3*DL
340 GOSUB 410
350 FORK=1 TO DL:NEXTK
360 NEXTJ
370 FORK=1 TO CS:NEXTK
380 RETURN
400 REM TONE GENERATION
410 POKE 950,8:POKE 951,12:SYS 845
420 FORK=1 TO T:NEXTK
430 POKE 950,8:POKE 951,0:SYS 845
440 RETURN
1000 REM SINGLE LETTERS
1005 PRINT "J"
1010 PRINT "ENTER REQUIRED SPEED"
1011 INPUT "(NUMBER OF 5 LETTER WORDS/MINUTE)":S
1015 PRINT "PRESS ANY LETTER OR NUMBER."
1020 GR=INT(EXP(5.28-.21*S))
1022 IC=3.10470588*GR
1024 DL=INT(IC-GR*LOG(S))
1026 CS=2*DL
1030 GET A$: IFA$="" THEN 1030
1035 IFA$="" THEN RETURN
1040 PRINT A$
1050 IF A$="" THEN FORK=1 TO DL*4:NEXT:GOTO 1030
1060 C=ASC(A$)-47
1070 GOSUB 310
1080 GOTO 1030
2000 REM IMPROVING SPEED
2005 PRINT "J"
2006 SV=1
2007 INPUT "RANDOM WORDS OR NUMBERS. W/N":A$
2008 IF LEFT$(A$,1)="N" THEN SV=0
2009 L5=10+SV*16:DT=L5
2010 PRINT "ENTER REQUIRED SPEED"
2012 INPUT "(NUMBER OF 5 LETTER WORDS/MINUTE)":S
2014 PRINT "HOW MUCH TIME DO YOU WANT TO REPLY?"
2015 INPUT "0 GIVES LEAST TIME, HIGHER NUMBERS MORE TIME":MAX:MAX=MAX*50
2018 PRINT "PRESS KEY TO START PROGRAMME."
2020 GR=INT(EXP(5.28-.21*S))
2022 IC=3.10470588*GR
2024 DL=INT(IC-GR*LOG(S))
2026 CS=2*DL
2028 GET A$: IFA$="" THEN 2026
2027 FORK=1 TO CS:NEXTK
2270 DT=L5/DT:FORK=SV*17+1 TO L5+SV*17:D(K)=D(K)*DT:NEXTK:DT=L5
2280 K=RND(1)*L5:C1=0:C=0+SV*17
2282 C=C+1
2284 C1=C1+D(C)
2286 IF C1=K THEN 2282
2290 DU=0:GOSUB 310
2300 GET A$: IFA$="" THEN DU=DU+1:GOTO 2300
2310 IF A$="" THEN RETURN
2312 IF A$="0" THEN 2320
2314 FOR I=SV*17+1 TO L5+SV*17:STEP 2
2316 PRINT CHR$(47+I);D(I)/L5;TAB(15);CHR$(47+I+1);D(I+1)/L5
2318 NEXT
2319 GOTO 2300
2320 IF DU<MAX THEN DT=DT-D(C)/4:D(C)=D(C)-D(C)/4:GOTO 2350
2340 IF DU>MAX THEN PRINT "TOO SLOW"
2350 PRINT CHR$(C+47);IFA$=CHR$(C+47) THEN PRINT "CORRECT":GOTO 2270
2400 DT=DT+D(C)*2:D(C)=D(C)+D(C)*2:PRINT:GOTO 2290
2410 GOSUB 310
2420 GET A$: IF A$="" THEN 2420
2420 IF A$=CHR$(C+47) THEN GOTO 2300
2440 GOTO 2410
3000 REM RANDOM WORDS
3005 PRINT "J"
3006 SV=1
3007 INPUT "RANDOM WORDS OR NUMBERS. W/N":A$
3008 IF LEFT$(A$,1)="N" THEN SV=0
3010 INPUT "NUMBER OF LETTERS PER WORD":NL
3020 INPUT "ENTER SPEED TO WHICH YOU ASPIRE":S
3030 GR=INT(EXP(5.28-.21*NL))
3032 IC=3.10470588*GR
3034 DL=INT(IC-GR*LOG(S))
3042 PRINT "HOW MUCH DO YOU WANT TO SLOW DOWN"
3044 PRINT "THE INTER LETTER INTERVAL?"
3045 PRINT "ENTER 0 IF YOU DON'T WANT A CHANGE"
3046 PRINT "ENTER A NUMBER GREATER THAN 0 TO SLOW IT DOWN PROPORTIONATELY"
3047 INPUT SL
3050 CS=2*DL+100*SL
3100 FOR I=1 TO NL
3120 C=INT(RND(1)*(10+SV*16)+1)+SV*17
3140 PRINT CHR$(C+47);
3150 GOSUB 310
3160 NEXT I
3200 FORK=1 TO CS:NEXTK
3220 PRINT
3240 GET A$: IFA$="" THEN RETURN

```

(listing continued on page 89)

How would a matrix printer costing £850 sell?

The ASP-3500 matrix printer is a high speed bi-directional printer capable of up to 180 characters per second output. Compact and lightweight, it contains four languages as standard character set and is available in two versions: A with 7x9 matrix for business use, giving a true descender; and B with 9x9 matrix for graphics work.

Printing flexibility is what this machine understands best. With a maximum of 181 kinds of character patterns, the ASP-3500 can handle British and American English, German and French. Variable print capability permits 10 cpi for normal characters,

5 cpi, 6 cpi, and 8.25 cpi for elongated characters, and 12 cpi and 16.5 cpi for compressed characters. Easily adjustable forms tractor mechanism allows you to use any size standard pin feed form, from 5 inches to 16 inches.

Precision wire heads can pound-out up to two hundred million maintenance-free characters. Heads come in two types, and are replaceable in the field, keeping costly down-time to a minimum.

The ASP-3500 with its ease of operation, light weight, compact size and quiet operation

make it welcome in any office environment. It features a standard systems self-test capability for maintenance ease. Heavy duty ribbon cartridge pops in, pops out, for clean, quick ribbon replacement. RS-232C standard interface, 20mA current loop or industrial standard parallel interface are also available.

If you're interested in distributing ASP-3500 in the UK, give us a call – at only £850 we think they'll sell like hot cakes!

Mitsui Computers,
Oakcroft Road,
Chessington, Surrey KT9 1SA.
Tel: 01-397 5111.
Telex: 929929 Mitmac G.

ASP-3500 is already available in the UK from:

A1 PERIPHERALS
Slough 0753 77619
AWS LTD
Guildford 0483 504234
BETA SERVICES (EAST ANGLIA) LTD
Norwich 0842 63041
COMPUTER SYSTEMS WESTERN
Plymouth 0752 25051
Redruth 0209 860628
G & M MANAGEMENT
SERVICES
Southampton 0703 30664
INTEC SYSTEMS
Slough 0753 28242
JENTECH SERVICES LTD
Bridgenorth 07462 5287
TEMPLEMAN SOFTWARE
Stratford 0789 66237
VEGA COMPUTERS
Croydon 01-680 4484



**ASP3500
MATRIX PRINTER**

(continued from page 87)

that is longer is assumed to be a Dah. The same applies to recognition of pauses within a character, between characters, and between words.

Once the machine is identifying when a character is being sent, the next task is to recognise the particular character that is present. As each Dit or Dah of a character is received it computes a running total, the final value of which uniquely identifies the character. The principle is shown in figure 1. This operation is performed in lines 4300 to 4480. I2 controls the raising of the power as each Dit or Dah in the character being received is identified.

T1 stores the running total for the character, and is then used as a pointer in the alphanumeric array Z\$, so that the

character is directly accessed and immediately printed on the screen by line 4450. This routine has successfully decoded ideal morse produced by running option 3 on an Exidy Sorcerer, and broadcast at speeds even exceeding those required for the Home Office test. It has also successfully decoded less than ideal morse code, inexpertly produced by the authors.

Random errors

Analysis of morse by the expert human operator is immediate and automatic and involves little if any conscious decision making. It is almost as if there is a direct link between the code and the character. The computer analysis of morse also possesses this quality of direct access. The running total produced by the real-time

analysis of the Dits and Dahs points unequivocally to the correct character.

One difference between the program and the human operator is that humans make errors, and these errors are not of a random nature. Characters may be confused with their mirror images for example, — A, with — · N. The program does not make this kind of error, though errors do arise when it can no longer cope with the speed of input.

Another way in which the program differs from humans is that it can only identify individual characters, whereas humans soon learn to recognise familiar letter patterns. It is possible to envisage modifications to the program that would lead to a closer match between its performance and that of a human being if this were desired. □

(listing continued from page 87)

```

3250 GOTO 3100
4000 REM DECODE MORSE
4005 PRINT "J"
4010 POKE 59459,0
4040 INPUT "WOULD YOU LIKE THE MACHINE TO ESTIMATE YOUR DIT LENGTH (Y/N)";A$
4050 IF A$="N" THEN INPUT "LENGTH OF DIT";DIT:GOTO 4250
4060 PRINT "TAP IN V, AT LEAST THREE TIMES"
4070 IF PEEK(59471)=255 THEN 4070
4080 FOR I=1 TO 12:SI=0
4090 POKE 950,8:POKE 951,15:SYS 845
4130 IF PEEK(59471) <> 255 THEN SI=SI+1:GOTO 4130
4141 POKE 950,8:POKE 951,0:SYS 845
4150 V(I)=SI
4160 NS=0
4170 IF I=12 THEN 4210
4180 IF PEEK(59471)=255 THEN NS=NS+1:GOTO 4180
4190 W(I)=NS
4200 NEXT
4210 DIT=V(4)+V(8)+V(12)
4220 DIT=INT((DIT/3)/2)+1
4240 PRINT "YOUR DIT LENGTH",DIT
4250 DL=40
4260 C=28:GOSUB 310
4300 NS=0
4310 I=0
4320 IF PEEK(59471)=255 THEN NS=NS+1:GOTO 4320
4330 IF NS > 4 * DIT THEN PRINT " "
4340 T1=0:I2=1
4350 FOR I=1 TO 5
4360 I2=I2*2
4370 POKE 950,8:POKE 951,12:SYS 845
4380 SI=0
4390 IF PEEK(59471) <> 255 THEN SI=SI+1:GOTO 4390
4400 POKE 950,8:POKE 951,0:SYS 845
4410 IF SI > DIT THEN T1=T1+I2:GOTO 4430
4420 T1=T1+I2/2
4430 NS=0
4440 IF PEEK(59471) <> 255 THEN 4470
4450 NS=NS+1:IF NS > DIT THEN PRINT Z$(T1):GOTO 4300
4460 GOTO 4440
4470 NEXT I
4480 GOTO 4300
7000 DATA LLLLL,SLLLL,S9LLL,SSLL,S99SL,SS9SS
7010 DATA LSSSS,LLSSS,LLLSS,LLLLS
7020 DATA SLSSL,LL9SL,SS9LS,LLSLLSL
7030 DATA LSLSL,LLLSSS
7040 DATA S9SLL
7070 DATA SL,LSSS,LSLS,LSS,S
7080 DATA S9LS,LLS,S99S,SS,SLLL
7090 DATA LSL,SLSS,LL,LS,LLL
7100 DATA S9LS,LLSL,SL9,S9S,L
7110 DATA S9L,S9SL,SLL,L9SL,L9LL,LLSS

```

APL — a high-level language whose time has come

To those used to the look of a Basic listing it may seem little more than a funny Greek language that executes backwards. Yet with a flexible and concise structure APL is set to come into its own, especially on the new generation of 16-bit machines. Adrian Smith explains why he has become an APL fan.

PEOPLE EITHER LOVE APL or hate it — there are few neutrals. Although the vast majority of APL systems at the moment are on mainframes, the new generation of 16-bit micros will be close to ideal as an environment for this language.

My own experience of computing has been of interactive Basic, and several years of batch PL/1, but two years of APL have convinced me that this language is usually a "better way".

Figure 1 based on "Obsolete Languages" from the house magazine of MicroAPL Ltd illustrates how concise APL can be. This example is rigged, but not as much as you might think. Software bureaux quote APL development costs at around one-fifth of the cost of the same system in, for instance, Cobol. Much of this saving simply reflects the vastly reduced keying time for the APL code.

APL uses some funny symbols: \div you may recognise, but there is also that Greek letter ρ to reckon with. As a result it needs specially adapted keyboards and printers, a considerable overhead when you first decide to try out APL. Fortunately most of the new generation of printers will take an APL daisywheel, and APL keyboards are an option on many standard ASCII screens. However, the character set remains a significant barrier to the wider acceptance of APL, and it needs simplifying.

APL-written systems can be run from normal keyboards, and you can cover for most of the common symbols with functions like:

MULT($\alpha \times \omega$ LN: $\ast \omega$ ANY: v/ω)

To an APL devotee such a course would be insufferably frustrating, but it may be the best way of introducing APL ideas to the micro world.

APL functions execute independently of the shape and size of the data they are fed. Mean would happily average two numbers or 20,000, and with a minor modification it would give you the row averages of a 50-by-100 table. An APL function represents a mathematical concept — a mean is not dependent on the number of numbers input.

APL conspicuously lacks control struc-

tures. You will search in vain for IF - THEN - ELSE, DO WHILE . . . , FOR I = 1 TO 10 . . . NEXT I

This is a dramatic divergence from mainstream computer languages.

The fundamental concept in commercial computing is the file. A commercial system consists of files which are updated, matched, merged and printed by a suite of programs. Each file consists of a number of identically structured records, each divided into fields.

In conventional data processing, the task of mapping a user's needs into files and programs, and deciding on the layout of the records within each file, falls to a systems analyst. The task of the programmer is to take the structures of the input and output files as given, and to devise the processing needed to map the one on to the other. The great triumph of the structured language is that it provides the ideal series of constructs through which the required mapping can take place.

Remember that APL is a mathematical notation, not a computer language. In a conventional employee-records file system each record contains the details of one employee, and the record layout might look something like figure 2. To

Name	Age	Sex	Salary
CCol	20 21 22 23 24 30		
BLOGGS F.	35	M	12300
HARRIS J.	62	M	5600
.	.	.	.
.	.	.	.

```

BEGIN
  DECLARE file structure;
  clear accumulator;
  UNTIL end of file DO
    READ a record;
    add salary to accumulator;
  END
  print accumulator;
END.
    
```

Figure 2. Typical employee-records file and a conventional approach to extracting information from it.

answer a question such as "What is the total salary bill?", use the kind of structure illustrated in the figure.

In an APL system, the files are treated simply as pigeon-holes for individual APL variables, rather than collections of identically structured records. The contents of each file component represent the values of one data item for all employees. For example if the company employed 1,200 people we might have: AGE . . . a numeric list (vector) of 1,200 ages NAME . . . a 1,200 by 20 character table of names etc.

To answer the question ". . . what is the average age in the company?", we need only type:

MEAN AGE

and

+ / SALARY

will tell us the total salary bill.

(continued on page 93)

Figure 1. Routines for calculating arithmetic means in Pascal, Basic and APL.

PASCAL	BASIC	APL
<pre> PROGRAM mean (input,output); VAR value,sum,mn:real; count:integer; BEGIN sum:=0; count:=0; read (value); WHILE not eof DO BEGIN sum:=sum+value; count:=count+1; read (value); END; mn:=sum/count; writeln ('Mean is ',mn) END. </pre>	<pre> 10 LET S=0 20 INPUT I,M 30 FOR N=1 TO M 40 INPUT I,V 50 LET S=S+V 60 NEXT N 70 PRINT S/M </pre>	<pre> MEAN: (+/ω) ρω </pre>

KAGA MONITORS GOOD LOOKS AT ATTRACTIVE PRICES.



Ideal for use with all popular makes of micro-computer, Kaga Monitors are available nationwide from Data Efficiency dealers.

Combining quality with reliability they offer high resolution and flicker-free non glare display suitable for both text and graphics.

Also available from Kaga is the 14" PAL Colour Monitor, which gives exceptionally clear definition and true colour. In addition there is a special colour monitor package incorporating a card for the Apple II.

All Kaga Video Monitors have the in-built reliability you'd expect

from solid state circuitry and come complete with video cable. Handsome economy? Its name is Kaga.

SPECIFICATIONS

KAGA 12" MONITOR: Green or B/W display
VIDEO INPUT SIGNAL: Composite video, negative sync
ACTIVE DISPLAY AREA: 235(W) x 185(H)mm
VIDEO BAND WIDTH: More than 18MHz (-3dB)
DISPLAY CHARACTERS: 80 characters with 25 lines
POWER SUPPLY: 230V AC \pm 10%
POWER CONSUMPTION: 26W
DIMENSIONS: 310(W) x 285(H) x 321(D)mm
WEIGHT (NET): 7kg

KAGA 12" GREEN DISPLAY MONITOR: £99.50*	£99.50*
KAGA 12" B/W DISPLAY MONITOR: £122*	£122.00*
KAGA 14" PAL COLOUR MONITOR: £249*	£249.00*
KAGA 14" PAL COLOUR MONITOR PLUS CARD FOR APPLE II: £296*	£296.50*

RING 0442 40571/2 FOR DETAILS OF YOUR NEAREST STOCKIST.

Sole UK Distributors, Data Efficiency Ltd., Computer Division, Finway Road, Hemel Hempstead, Herts. HP2 7PS Trade and OEM enquiries welcome.

*Prices correct at time of going to press.

IDEI
Data Efficiency Ltd

● Circle No. 156

(continued from page 91)

The prime purpose of programming structures is to handle repetitive processing through files. When you can see all the data all the time, your life becomes a great deal more straightforward, and in practice the structures are rarely missed. APL is a consistent, concise mathematical notation. It handles lists and tables of data very naturally and is highly interactive. APL is also interpretive, and its workspace concept makes very considerable demands on a computer's working storage.

In APL, all data management is handled by the interpreter statement-by-statement. There are no Declare or Dimension statements at all. Consider the following three valid APL commands:

```
A←'CAT' ... create a variable "A" with the
value of a character vector
"CAT"

A←100 50p10 ... make "A" a numeric table
(100 rows by 50 cols)
with the value 10.

A←-,A ... "A" is now a numeric vector of
length 5,000, still containing the
value 10 throughout.
```

This gives the programmer an enormous amount of freedom in manipulating data. To aggregate 12 months' sales figures into four quarterly totals, one simply reshapes the figures as a four-by-three table:

```
FIGS←4 3pFIGS
and sums across the rows
QUART←+/FIGS
```

APL subroutine structures are flexible. Here is an alternative definition of the function Mean:

```
MEAN: (TOTAL ω) ÷ ρω
where the function Total looks like:
TOTAL: +/ω
```

Any APL function can call any other APL function including itself without making special arrangements. Just as you can string together the familiar functions of mathematics such as \ln , \cos , ω , where each may have been previously defined at a lower level, so you can string together the functions of APL.

Functions old and new

To revert once more to the staff-file example — what would it cost the company to pay all its 21-year-old staff a 6 percent rise?

```
0.06 × TOTAL SALARY WHERE AGE = 21
1925.82
```

Here two primitive functions from mathematics, multiply and the test for equality, have been strung together with two of our own invention. Total has already been illustrated; the deceptively straightforward looking "Where" shows another facet of APL's data management at work:

```
WHERE: ω/α
```

This phenomenon is called "compression" and is probably best illustrated by another example:

```
'ABCDE' WHERE 0 1 1 0 1
BCE
```

Here a vector of length 5 has been passed through a logical sieve also of five elements; only where the corresponding element in the sieve is "on" do we pass the value in the original vector. The length of the result is clearly three — the same as the number of ones in the sieve.

If our company employs four 21-year-old staff, we might find:

```
SALARY WHERE AGE = 21
8760 5678 10001 7658
```

Finally, a passing swipe at all the computer languages which use = to double for assign. In APL the result of:

```
1 = 1 + 1
```

is zero, meaning "this expression is false".

APL interpreters are hard to write and tend to be memory intensive. The toughest problem the interpreter has to handle is the organisation of the APL workspace. The microcomputer — with its straggled ranks of directly addressable RAM — was always a tempting proposition. The solution was to compromise; implement a reasonable subset of APL and leave about half the magic 64K available as workspace. A smaller interpreter

```
COSTS-2 3 2 4
SALES-5 6 6 5
PROFIT=SALES-COSTS
INFLATION-1-08 1.12 1.15 1.12
DISCOUNTED&PROFIT=PROFIT*/^INFLATION

'ZZZ.9' PRCFIT DISCOUNTED&PROFIT
2.78
2.48
2.88
0.64
```

Figure 3. Specifying rows as APL variables.

would have strayed too far from the mainframe standard; any larger and the lack of workspace would start to bite.

The result has been a string of very similar micros, running virtually the same APL at the same speed. The Superbrain and the Shelton Sig/Net are typical examples. The systems differ among themselves and from mainframe APL in their file handling. This has turned out to be something of a paradox: the restriction on workspace has forced the micro-APLs into file-access mechanisms which are often far superior to the IBM offering.

Typically a hybrid system will use APL's component files to store personnel details and conventional CPM files to hold WordStar documents. WordStar can do what it is best at — document composition — to generate a set of "Dear Blank," letters. APL can select and massage data to fill in the appropriate blanks on the correct letters and print them out in a sensible sequence.

```
CIRCULATE 'BONUS.TEXT' TO STAFF
WITH ABSENCE < 5
```

Micros are also closer to the real world than mainframes, and APL systems have been coupled up to all sorts of dataloggers and process-control systems. APL was never designed for this, but if you

have to deal with an arbitrary splurge of binary data then it is handy to have a series of logical functions which will operate on practically anything as long as it has noughts and ones in it.

The major barrier to a full-scale micro-APL has always been the 64K addressing limit of the eight-bit systems. A typical APL application sits in about 250K of workspace, and a full APL interpreter probably needs about 100K on top of that. The answer of course, is already with us — with 16-bit addressing, the only remaining limit is the number of memory chips we can cram into the cabinet!

Future applications

The next generation of micros will be far better suited to the needs of APL than are many of today's big mainframes. APL does not run happily in virtual storage systems, particularly if it has to compete with batch jobs and conventional transaction processing. If you try and add up the last column of a 100K four-dimensional array you may get some dramatically variable response times as the system pages desperately through it.

In the megabyte micro the philosophy is totally different — storage is real, cheap, easily addressed and extremely fast. On a Motorola 68000 the response time to such a request would be well under a second, and it would be absolutely consistent. Add to this the fact that the new APLs are inheriting all the enhanced file access that the old eight-bit systems needed and the combination will prove hard for many of us mainframers to resist.

An early use of APL was as an advanced pocket calculator. Engineers frequently find themselves faced with systems of linear equations, and the APL matrix divide was implemented specifically to solve these. They also tend to need large tabulations of data, and APL will often do the job in a fraction of the time that a hand calculation would take.

Data manipulation

APL scored a more dramatic early success in the field of financial modelling. Even rather sophisticated economic models are simply built round tables of data. Some rows are entered by the user, some are calculated from combinations of these.

The early approach as shown in figure 3 was simply to specify the user's rows as APL variables, and to use primitive APL to evaluate the relationships. These days it is all wrapped up in user-friendly dialogues and menus.

APL has come into use as a tool for storing, manipulating and displaying simple tabular data. The staff file is typical, and other examples might include historical sales data, or a parts inventory for a warehouse. There is no doubt that the efficient manipulation of either text or

(continued on page 96)

New ZX81 Software from Sinclair.

A whole new range of software for the Sinclair ZX81 Personal Computer is now available – direct from Sinclair. Produced by ICL and Psion, these really excellent cassettes cover games, education, and business/household management.

Some of the more elaborate programs can only be run on a ZX81 augmented by the ZX 16K RAM pack. (The description of each cassette makes it clear what hardware is required.) The RAM pack provides 16-times more memory in one complete module, and simply plugs into the rear of a ZX81. And the price has just been dramatically reduced to only £29.95.

The Sinclair ZX Printer offer full alphanumeric and highly-sophisticated graphics. A special feature is COPY which prints out exactly what is on the whole TV screen without the need for further instructions. So now you can print out your results for a permanent record. The ZX Printer plugs into the rear of your ZX81, and you can connect a RAM pack as well.

Games

Cassette G1: Super Programs 1 (ICL)

Hardware required – ZX81.

Price – £4.95.

Programs – Invasion from Jupiter. Skittles. Magic Square. Doodle. Kim. Liquid Capacity.

Description – Five games programs plus easy conversion between pints/gallons and litres.

Cassette G2: Super Programs 2 (ICL)

Hardware required – ZX81.

Price – £4.95.

Programs – Rings around Saturn. Secret Code. Mindboggling. Silhouette. Memory Test. Metric conversion.

Description – Five games plus easy conversion between inches/feet/yards and centimetres/metres.

Cassette G3: Super Programs 3 (ICL)

Hardware required – ZX81.

Price – £4.95.

Programs – Train Race. Challenge. Secret Message. Mind that Meteor. Character Doodle. Currency Conversion.

Description – Fives games plus currency conversion at will – for example, dollars to pounds.

Cassette G4: Super Programs 4 (ICL)

Hardware required – ZX81.

Price – £4.95.

Programs – Down Under. Submarines. Doodling with Graphics. The Invisible Invader. Reaction. Petrol.

Description – Five games plus easy conversion between miles per gallon and European fuel consumption figures.

Cassette G5: Super Programs 5 (ICL)

Hardware required – ZX81 + 16K RAM.

Price – £4.95.

Programs – Martian Knock Out. Graffiti. Find the Mate. Labyrinth. Drop a Brick. Continental.

Description – Five games plus easy conversion between English and continental dress sizes.

Cassette G6: Super Programs 6 (ICL)

Hardware required – ZX81 + 16K RAM.

Price – £4.95.

Programs – Galactic Invasion. Journey into Danger. Create. Nine Hole Golf. Solitaire. Daylight Robbery.

Description – Six games making full use of the ZX81's moving graphics capability.

Cassette G7: Super Programs 7 (ICL)

Hardware required – ZX81.

Price: – £4.95.

Programs – Racetrack. Chase. NIM. Tower of Hanoi. Docking the Spaceship. Golf.

Description – Six games including the fascinating Tower of Hanoi problem.

Cassette G8: Super Programs 8 (ICL)

Hardware required – ZX81 + 16K RAM.

Price – £4.95.

Programs – Star Trail (plus blank tape on side 2).

Description – Can you, as Captain Church of the UK spaceship Endeavour, rid the galaxy of the Klingon menace?

Cassette G9: Biorhythms (ICL)

Hardware required – ZX81 + 16K RAM.

Price – £6.95.

Programs – What are Biorhythms? Your Biohythms.

Description – When will you be at your peak (and trough) physically, emotionally, and intellectually?

Cassette G10: Backgammon (Psion)

Hardware required – ZX81 + 16K RAM.

Price – £5.95.

Programs – Backgammon. Dice.

Description – A great program, using fast and efficient machine code, with graphics board, rolling dice, and doubling dice. The dice program can be used for any dice game.

Cassette G11: Chess (Psion)

Hardware required – ZX81 + 16K RAM.

Price – £6.95.

Programs – Chess. Chess Clock.

Description – Fast, efficient machine code, a graphic display of the board and pieces, plus six levels of ability, combine to make this one of the best chess programs available. The Chess Clock program can be used at any time.



Cassette G12: Fantasy Games (Psion)

Hardware required – ZX81 (or ZX80 with 8K BASIC ROM) + 16K RAM.

Price – £4.75.

Programs – Perilous Swamp. Sorcerer's Island.

Description – Perilous Swamp: rescue a beautiful princess from the evil wizard. Sorcerer's Island: you're marooned. To escape, you'll probably need the help of the Grand Sorcerer.

Cassette G13: Space Raiders and Bomber (Psion)

Hardware required – ZX81 + 16K RAM.

Price – £3.95.

Programs – Space Raiders. Bomber.

Description – Space Raiders is the ZX81 version of the popular pub game. Bomber: destroy a city before you hit a sky-scraper.

Cassette G14: Flight Simulation (Psion)

Hardware required – ZX81 + 16K RAM.

Price – £5.95.

Program – Flight Simulation (plus blank tape on side 2).

Description – Simulates a highly manoeuvrable light aircraft with full controls, instrumentation, a view through the cockpit window, and navigational aids. Happy landings!

Education

Cassette E1: Fun to Learn series – English Literature 1 (ICL)

Hardware required – ZX81 + 16K RAM.

Price – £6.95.

Programs – Novelists. Authors.

Description – Who wrote 'Robinson Crusoe'? Which novelist do you associate with Father Brown?

Cassette E2: Fun to Learn series – English Literature 2 (ICL)

Hardware required – ZX81 + 16K RAM.

Price – £6.95.

Programs – Poets. Playwrights. Modern Authors.

Description – Who wrote 'Song of the Shirt'? Which playwright also played cricket for England?

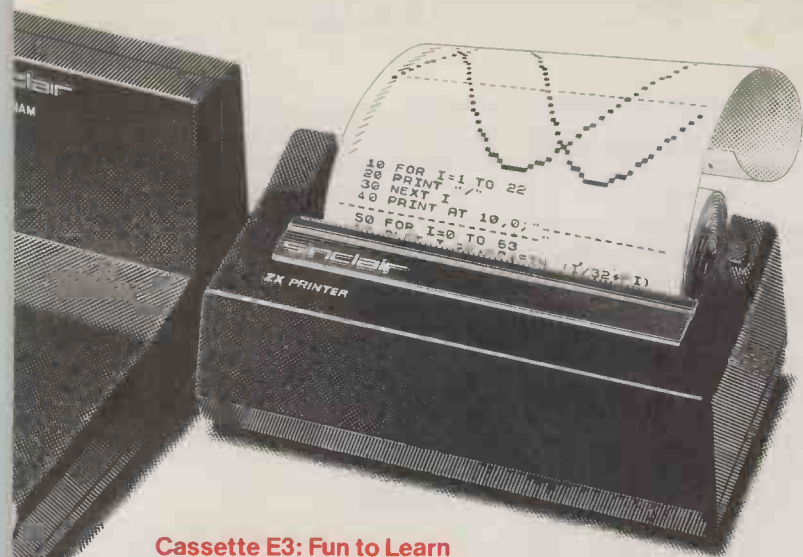

Cassette E3: Fun to Learn series - Geography 1 (ICL)

Hardware required - ZX81 + 16K RAM.

Price - £6.95.

Programs - Towns in England and Wales. Countries and Capitals of Europe.

Description - The computer shows you a map and a list of towns. You locate the towns correctly. Or the computer challenges you to name a pinpointed location.

Cassette E4: Fun to Learn series - History 1 (ICL)

Hardware required - ZX81 + 16K RAM. Price - £6.95.

Programs - Events in British History. British Monarchs.

Description - From 1066 to 1981, find out when important events occurred. Recognise monarchs in an identity parade.

Cassette E5: Fun to Learn series - Mathematics 1 (ICL)

Hardware required - ZX81 + 16K RAM. Price - £6.95.

Programs - Addition/Subtraction. Multiplication/Division.

Description - Questions and answers on basic mathematics at different levels of difficulty.

Cassette E6: Fun to Learn series - Music 1 (ICL)

Hardware required - ZX81 + 16K RAM. Price - £6.95.

Programs - Composers. Musicians. Description - Which instrument does James Galway play? Who composed Peter Grimes'?

Cassette E7: Fun to Learn series - Inventions 1 (ICL)

Hardware required - ZX81 + 16K RAM. Price - £6.95.

Programs - Inventions before 1850. Inventions since 1850.

Description - Who invented television? What was the 'dangerous Lucifer'?

Cassette E8: Fun to Learn series - Spelling 1 (ICL)

Hardware required - ZX81 + 16K RAM. Price - £6.95.

Programs - Series A1-A15. Series B1-B15. Description - Listen to the word spoken on your tape recorder, then spell it out on your ZX81. 300 words in total suitable for 6-11 year olds.

Business/household

Cassette B1: The Collector's Pack (ICL)

Hardware required - ZX81 + 16K RAM.

Price - £9.95.

Program - Collector's Pack, plus blank tape or side 2 for program/data storage.

Description - This comprehensive program should allow collectors (of stamps, coins etc.) to hold up to 400 records of up to 6 different items on one cassette. Keep your records up to date and sorted into order.

Cassette B2: The Club Record Controller (ICL)

Hardware required - ZX81 + 16K RAM.

Price - £9.95.

Program - Club Record Controller plus blank tape on side 2 for program/data storage.

Description - Enables clubs to hold records of up to 100 members on one cassette. Allows for names, addresses, 'phone numbers plus five lots of additional information - eg type of membership.

Cassette B3: VU-CALC (Psion)

Hardware required - ZX81 + 16K RAM.

Price - £7.95.

Program - VU-CALC.

Description - Turns your ZX81 into an immensely powerful analysis chart.

VU-CALC constructs, generates and calculates large tables for applications such as financial analysis, budget sheets, and projections. Complete with full instructions.

Cassette B4: VU-FILE (Psion)

Hardware required - ZX81 + 16K RAM.

Price - £7.95.

Programs - VU-FILE. Examples.

Description - A general-purpose information storage and retrieval program with emphasis on user-friendliness and visual display. Use it to catalogue your collection, maintain records or club memberships, keep track of your accounts, or as a telephone directory.

How to order

Simply use the FREEPOST order form below and either enclose a cheque or give us your credit card number. Credit card holders can order by phone - simply call Camberley (0276) 66104 or 21282 during office hours. Either way, please allow up to 28 days for delivery, and there's a 14-day money-back option, of course.

**sinclair
ZX81
SOFTWARE**

Sinclair Research Ltd,
Stanhope Road, Camberley, Surrey,
GU15 3PS.

Tel: Camberley (0276) 66104 & 21282.

To: Sinclair Research, FREEPOST, Camberley, Surrey, GU15 3BR.
Please send me the items I have indicated below.

Qty	Cassette	Code	Item price	Total	Qty	Cassette	Code	Item price	Total
	G1: Super Programs 1	30	£4.95			E2: English Literature 2	45	£6.95	
	G2: Super Programs 2	31	£4.95			E3: Geography 1	46	£6.95	
	G3: Super Programs 3	32	£4.95			E4: History 1	47	£6.95	
	G4: Super Programs 4	33	£4.95			E5: Mathematics 1	48	£6.95	
	G5: Super Programs 5	34	£4.95			E6: Music 1	49	£6.95	
	G6: Super Programs 6	35	£4.95			E7: Inventions 1	50	£6.95	
	G7: Super Programs 7	36	£4.95			E8: Spelling 1	51	£6.95	
	G8: Super Programs 8	37	£4.95			B1: Collector's Pack	52	£9.95	
	G9: Biorhythms	38	£6.95			B2: Club Record Controller	53	£9.95	
	G10: Backgammon	39	£5.95			B3: VU-CALC	54	£7.95	
	G11: Chess	40	£6.95			B4: VU-FILE	55	£7.95	
	G12: Fantasy Games	41	£4.75			ZX 16K RAM pack	18	£29.95	
	G13: Space Raiders & Bomber	42	£3.95			ZX Printer	27	£59.95	
	G14: Flight Simulation	43	£5.95			Post & packing - only if ordering hardware		£2.95	
	E1: English Literature 1	44	£6.95						

TOTAL £ _____

I enclose a cheque/postal order to Sinclair Research Ltd for £ _____

Please charge my *Access/Barclaycard/Trustcard no.

*Please delete as applicable.

Mr/Mrs/Miss _____

Address _____

NSA 10

(continued from page 93)

tabular data requires a VDU. Packages like VisiCalc have shown the way, and the provision of good screen-based editors has been an enormous step forward for APL systems.

Consider the following dialogue to impose ad-hoc restrictions in a production-planning system:

Unavailable . . . the name of the function

Which machine ? :- Punch

Which day/shift :- Mon PM, Wed AM

Which machine ? :- Lath

<<Lath>> is not a known abbreviation . . . please retry

Which machine ? :- Lathe

and so on

On a VDU the whole rigmarole goes out of the window. You simply slap on the screen a table such as shown in figure 4, and type all over it. The VDU is a two-dimensional input device ideally suited to APL's table-handling capabilities.

Human replacement

Historically the aim of computer systems has been to replace humans as decision takers. When it has been a matter of rather simple decisions, the replacement has been extremely effective. Short-term planning has usually proved impossible to achieve. The failure of optimising algorithms when faced with multiple objectives, and the impossibility of including any political feel are major problems.

	MON			TUE			WED		
	AM	PM	EV	AM	PM	EV	AM	PM	EV
PUNCH	X						X		
LATHE									

Figure 4. VDU table display under APL.

Computers have been more successful taking care of the routine tasks, and helping the planner with carefully structured displays of the data.

It has often proved possible for a rather simple-minded algorithm to do 90 percent of a complex plan such as a school timetable very easily. The great strength of decision-support systems is knowing where to stop — that last 10 percent is far better left to the planner's intuition, experience, and political judgement.

Defining decision-support systems is important.

- They are highly interactive, with a genuine partnership between human and machine.
- They tend to be one-offs. Unless the program's internal model reflects accurately all the quirks and inconsistencies of the real world it is worse than useless. Of course there are common factors, but there is also a large amount of code which is highly specific.
- They must be extremely adaptable — as the world changes the system must follow it, and fast.
- The user interface must be responsive, sophisticated and robust — probably a VDU, possibly with colour and graphics.

First contact with a user to working

prototype should take one week. From then on the pace at which the system evolves is governed largely by the rate at which the user adapts to it. APL's incredibly flexible subroutine structure makes it possible to pull a system apart and re-assemble it in a different order. It also allows you to mess around with the dialogue without ever touching the algorithmic core of the program. As for the core itself, APL is first and foremost a means of expressing technical algorithms clearly and concisely and it is still supremely good at its job.

Versatility

People have used APL for the most unlikely things from computer-aided design, through word processing and document composition, to simulation and real-time process control. Graphics is the single future development that fascinates me most, particularly having realized that most of the things you do to graphic objects — translation, rotation and the like — can be expressed very simply in matrix algebra.

Because APL is so much higher level than, say, Basic or PL/I it makes correspondingly heavier demands on the CPU. Computers however are getting cheaper — people are not — and in the end a move to higher-level languages is inevitable. For the next few years at least, APL looks to have the field pretty well to itself.

SOFTWARE FOR CP/M®

HIGH QUALITY SOFTWARE — WITH HIGH QUALITY SERVICE

★ NEW THE FORMULA £300. Application Builder and Reporter. SPELL STAR £125. Option for Wordstar. SUPER CALC £165. Spread Sheet financial planning.

WORDSTAR - Professional word processing software. On-screen formatting, wordwrap, pagination, line and character count on view. Micro-justification on daisy-wheel printer. Search and replace. Block/paragraph manipulation. External file read/writes. Background printing during editing etc.	£250	MICROSOFT FORTRAN COMPILER	£205
MAIL-MERGE - Powerful Wordstar enhancement for file merging and document personalisation.	£65	MICROSOFT COBOL	£310
DATASTAR Screen orientated system for Data Entry, Retrieval and Updating.	£175	MAGSAM - Versatile easy to use Keyed File Management System for Microsoft Basic or CBASIC.	£130
SUPERSORT - Sort, merge and selection program.	£125	CIS - COBOL - ANSII 74 implementation to full level 1 standard. Supports random, indexed and sequential files, features for conversational working, screen control, interactive debugging, program segmentation etc.	£425
CONFIGURABLE BUSINESS SYSTEM (CBS) - Unique information management system with user definable files, powerful report generator, menu-driven for ease of use. No programming experience necessary!	£225	FORMS-2 - Automatic COBOL code generator for screen formats.	£100
ACCOUNTING PACKAGES by Median - Tec: PAYROLL, SALES, PURCHASE, NOMINAL Specially developed by UK software house to exacting specifications. Written in Microsoft Basic each package may be customised by end user, all are widely used. Ledgers are open item. Payroll caters for weekly and monthly pay.	£300 each	PASCAL-Z	£255
PROJECT COST CONTROL/JOB ACCOUNTING - A comprehensive set of programs to monitor budgets, account for expenditure and project completion etc. Ideally suited for contractors. Written in CBASIC-2.	£150	STRUCTURED BASIC - Relocatable compiler	£160
STATISTICS PACKAGE - Over 25 routines including Regression & ANOVA	£100	CBASIC-2 - Extended Disk Basic pseudo compiler and run-time interpreter.	£75
MATHS PACKAGE - Over 40 easily used routines.	£100	SELECTOR III - C2 - Information management system written in CBASIC-2	£185
IBM - CP/M COMPATIBILITY - Powerful utility to transfer data to/from IBM machines in standard disk format.	£110	SELECTOR IV - Upward compatible version of III with enhanced reporting.	£300
MICROSOFT BASIC INTERPRETER	£155	BSTAM - Telecomms facility for exchanging files between CP/M computers.	£100
MICROSOFT BASIC COMPILER	£205	ASCAM - Facility for communicating with other computers.	£95
		TRANSFER - CP/M to CP/M file exchange - telecomms source code	£95
		MACRO 80 - Macro Assembler	£99
		CP/M 2.2 - Standard Version 8" Single Density.	£99

Please contact us for availability of other products
All orders must be PREPAID. Add £1 per item P & P (Minimum £2.00) and VAT
CP/M is trade mark of Digital Research



TELESYSTEMS LTD

P.O. Box 12, GREAT MISSENDEN, BUCKS, HP16 9DD

Telephone (02406) 5314



A CUMANA FIRST FOR APPLE II

Quality Disk Drives, the 8035, with over twice the capacity per drive *(Hardly any extra cost! Try us)*



A BIG PLUS!
includes
SWITCH UNIT
for 80 or 35
track use

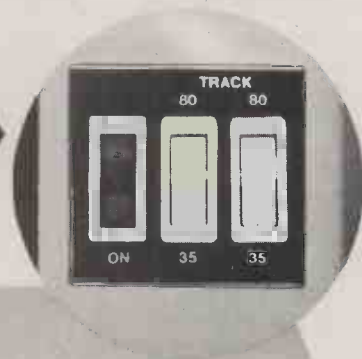

In 80 Track Mode capacity is **327680 bytes** on each drive.
In 35 Track Mode capacity is **143360 bytes** on each drive.
And all Apple Software including 1/2 track software can be read.
Apple owners will find the above units . . . quiet and dependable
. . . real professional users units giving essential standards of
data integrity.

Please add VAT to all prices. Delivery at cost will be advised at time of order.

CUMANA LTD

35 Walnut Tree Close, Guildford, Surrey GU1 4UN
Telephone: (0483) 503121. Telex: 858306

A low cost Apple Computer single Disk Drive . . . a really quiet, dependable unit.

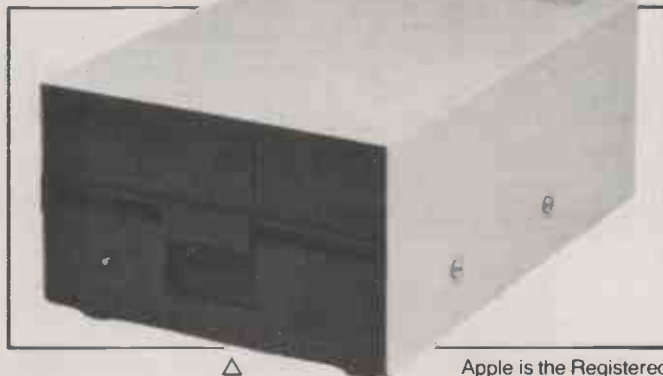

Apple is the Registered
Trade Mark of Apple Inc.

DEALER ENQUIRIES WELCOME. WE OFFER GENEROUS DEALER DISCOUNTS

FDos routines inside CP/M can be put to practical use as a security system in machine-code programs of your own, explains Adrian Hill.

Secrets of the password

MACHINE-CODE routines within CP/M can be used as the basis of an effective "password" system. This program allows disc access to only those users able to input a specific password.

The system consists of two separate routines. CLOSE.COM changes the names of all files on a disc from the normal upper-case characters, to lower-case characters, rendering these files inaccessible in the normal manner. Before termination, CLOSE.COM searches the

directory for a file named "open.com" and renames it "OPEN.COM". Thus this file will be the only one executable by the user.

The second routine, OPEN.COM, asks the user to input the password, checks its validity against the real password, and if it is valid reverses the action of CLOSE.COM to convert all files from lower- to upper-case character names, restoring the disc directory to its original state. It thus allows normal disc access

'until CLOSE.COM is executed again.

To operate the system, the user simply executes CLOSE.COM at the termination of a CP/M session, and then executes OPEN.COM when starting the next session. Remember that Open and Close work on individual discs, and not the disc system itself. Each disc used must be individually Opened and Closed, which has the side-effect of allowing individual discs their own password, if required.

Each disc used under CP/M has an area known as the directory which contains a file-control block, FCB, for each file on the disc. The FCB contains the file name and file type together with various other information. CP/M contains no routines to allow direct access to the whole of the directory, so it is not possible to load it all into RAM as a single entity.

However, it is possible to load specific parts of the directory into the disc input/output buffer at default location 0080 to 00FFhex. This is accomplished using the primitive numbers 17 and 18 which search the directory for the first, 17, and subsequent, 18, files which match the file name and type in a key FCB at the location pointed to by register D/E.

When using these primitives, the disc buffer is filled with that part of the directory containing the FCB of the matching file. In the 80hex bytes, there is room for four FCBs of 20hex, or 32 decimal, bytes each. One of this four will be the required FCB; which one, is indicated by the value of the lowest two bits, that is 0, 1, 2, 3, in register A.

Further, there is no routine in the FDos which allows the contents of the directory to be loaded into RAM, in parts, from the beginning to the end. You can only search the directory for a file to match the name and type given in the FCB set up at the location pointed to by register D/E.

You can, however, achieve the same result by an indirect approach. CP/M has the facility to allow a "wild" character in a file name, which will be matched in the match FCB primitives by any character. The "wild" character is "?", so if the FCB which is set up contains the file name and type

???????????

this will be matched by any possible file

(continued on page 101)

Figure 1.

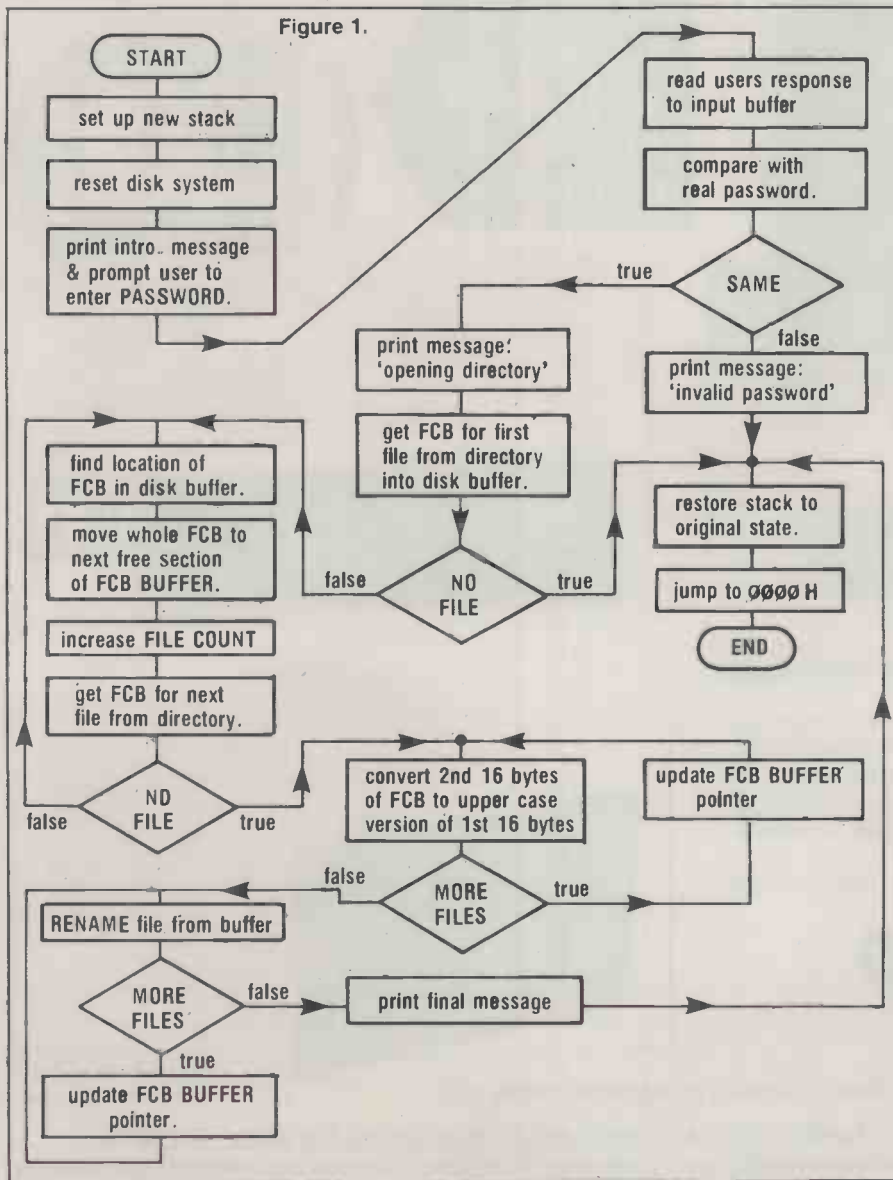

VISICALC 80 COLUMN DISPLAY on an APPLE II!

Yes, now its possible for all VISICALC users to obtain Screen Display in 80 COLUMNS, and to have additional memory available for VISICALC applications !!

Install one Saturn 128K Board and get 145K for Visalc

Install one Saturn 32K Board and get 49K for Visicalc

Install one Saturn 128K Board plus one 32K Board = 177K for Visicalc

VC EXPAND 80 TO GIVE ADDITIONAL MEMORY AND 80 CULUMN DISPLAY - £69.00

VC EXPAND WITHOUT 80 COLUMN DISPLAY - £55.00

VIDEX VISICALC 80 COLUMN SOFTWARE (No Memory Expansion) - £29.95

SATURN 128K BOARD - £359

SATURN 32K BOARD - £149

VIDEX VIDEO TERM - £195

VIDEX 40/80 Col Software Controlled Switch - £19.95

NEW PACKAGING From VISICORP

* VISICALC	£105.00
* VISIFILE	£139.00
* VISITERM	£ 79.00
* DESKTOP/PLAN	£105.00
* VISIDEX	£105.00
* VISIPILOT	£ 89.00
* VISITREND/PLOT	£139.00

NEW

VISISCHEDULE

The Visischedule programme is a powerful project planner that gives you both the overview & the details you need to control projects, meet deadlines, level resources, and beat cost targets

£189.00

DESKTOP/PLAN III £189.00

MACHINE COVERS - only the best

material used	
Apple only	£5.95
Single Disk	£2.95
2 stacked disks	£4.45
Apple, 2 disks and 9" monitor or Apple and 12" monitor	£8.95
Apple and 2 disk	£7.95
Epson MX 70/80	£5.45
Paper Tiger 445 - 460	£5.45
Hitachi 12" cover	£7.50
Qume Sprint 5 cover	£10.95
Apple /// cover inc monitor ///	£12.95
Sirius Machine and monitor cover	£12.95
Epson MX 100	£7.45

UTILITIES

BACK IT UP BIT COPIER	£39.95
SUPER DISK COPY III	£17.95
DISK RECOVERY	£17.95
DISK ORGANISER II	£17.95
MULTI DISK CATALOG III	£15.95
APPLESOFT & STRUCTURED BASIC	£15.95
DOS PLUS	£15.95
QUICKLOADER	£15.95
APPLESOFT PROGRAM OPTIMISER	£13.95
MACRO SCREEN EDITOR	£29.95
MON & DISK	£21.95
APPLE DOC	£29.95
ACE (Applesoft Command Editor)	£21.95
LIST MASTER	£22.95
DAKIN 5 PROGRAMMING AIDS 3.3	£49.95
HIGHER TEXT II	£21.95
HIGHER GRAPHICS II	£18.95
HIGHER FONTS I	£8.95
DIRECTORY MANAGER	£18.95
PROGRAM LINE EDITOR	£21.95
MICROSOFT A.L.D.S.	£79.00
MICROSOFT TASC -	
The APPLE Compiler	£109.00
MICROSOFT APPLE Z80 -	
Basic Compiler	£209.95

SYNERGIZER with FREE SUPERCALC

contains
Z-Card Z-80 Processor Card
C/PM OP System and Lincence
Rodney Zaks C/PM manual from Sybex
16K ADD RAM Ramcard
Smarterm 80 col card with enhanced CHR set and integral softswith together with free Supercalc

SUMMER SPECIAL ! £449.00

Z-CARD WITH
SUPERCALC and CP/M
SPECIAL PRICE £199.00



**Pete & Pam
Computers**



Mail Order & Distribution:
Waingate Lodge, Waingate Close,
Rossendale, BB4 7SQ
Phone: (0706) 227011
Telex: 635740 Petpam G

London Retail:
103-5 Blegborough Road,
London, SW16 6DL
Phones: 01-769 1022/3/4

NEW

BAG OF TRICKS

From the authors of Beneath Apple DOS

Includes many "hand holding" tutorials that assist you in repairing damaged diskettes and allow you to change sector ordering, reconstruct blown catalogs, etc.

£21.95

TRIPLE YOUR DISK ACCESS SPEED

No hardware modification required.

FastDOS

Fast Disk operating system for APPLE II computers.

Completely compatible with DOS disks
Loads and saves standard DOS files.

Completely compatible with all DOS/APPLESOFT programs that access DOS through standard hooks, including FID and MUFFIN

Executes all standard DOS commands

Comparative timings:	DOS	FDOS
Blooding integer basic	13 sec	3 sec
Cataloging a 12 file disk	2 sec	1 sec
Saving a 10 sector program	6 sec	2 sec
Saving a 100 sector program	34 sec	7 sec
Loading a 100 sector program	24 sec	7 sec

Requires 48K

Recommended Retail Price £19.95

THIS MONTH'S SPECIALS

UZ80 Processor Card	£69.00
DIGITEK Colour Card	£89.00
16K RAM CARD	£65.00
EXPEDITER II	£39.95
BATTLE OF SHILOH	£24.95
MATHEMAGIC	£49.95
OSBORNE C/PM USER GUIDE . . .	£9.95
(Book - No VAT)	
CALCSTAR For APPLE WORDSTAR SYSTEMS	£59.00



A BIG HIT AT APPLE '82

The amazingly compact
MICROWATCH real time clockcard
and ELECTRONIC DIARY software
for your APPLE II computer

£59.00

(continued from page 98)

name. The match FCB primitives then have the effect of becoming "find first file" or "find next file" in the directory, rather than finding the first and next matching file.

Using this method it becomes possible to scan the directory effectively. The FDos also indicates when there are no further files in the directory by returning the value FFhex in register A on return from the match FCB primitives. This return value actually indicates that there is no file in the directory to match the selected FCB. As this would be matched by any file, it effectively indicates "no more files".

There is one major problem to be overcome when using this method. The disc buffer will only be large enough to hold four FCBs from the directory, so when it is full you must either rename these four files before proceeding, or move them to another, larger buffer. This decision is dictated by the fact that no intervening FDos calls can be made between use of the match FCB primitives, as the system would "lose its place in the directory" during other calls.

Thus a large buffer must be set up to hold an FCB for each file on the disc. You then have to move all the FCBs to this area when the FDos finds them, keep a count of the number of FCBs found, and then rename them all, once the last FCB has been moved.

The logic for this program is given in a procedural flowchart in figure 1, the program itself is in the assembler listing produced by ASM.COM. Both the flowchart and the listing refer to OPEN.COM, as this is the most complex of the pair of programs. CLOSE.COM is almost identical, except for variations:

None of the program lines referring to the password are required in CLOSE.COM. So delete the source lines in the listing, which are assembled at the locations 0124 to 0125 and 0276 to 02BEhex.

M2Buffer, M4Buffer and M1Buffer are not required in CLOSE.COM. M3Buffer should be relabelled M4Buffer.

MXBuffer in CLOSE.COM should read:

```
MXBUFFER DB ' CLOSING DIRECTORY
           - PLEASE WAIT.'
```

The conversion of the file names in CLOSE.COM requires the value 20hex to be added to each character, not subtracted as in OPEN.COM. So delete the source

lines at locations 0337 and 0339. In the line at location 033C, change SUI to ADI. One extra piece of code must be added: the routine that will convert back to upper case the file now named "open.com", so that it will be executable by the user when he wishes to run it. Insert the following lines before

```
FEND LHLD OLD$SP
```

which is five lines from the end:

```
MVI C, RENAMEF
LXI D, SPFCB
CALL FDOS
JMP FEND
SPFCB DB 0,6FH, 70H, 65H, 6EH, 20H,
        20H, 20H, 63H, 6FH, 6DH
DB 0,0,0,0, 'OPEN COM', 0,0,0,0
```

These changes should be made to the source code for OPEN.COM and then assembled using ASM. The resulting hex file should be saved as a command file using DDT to load it into RAM.

The only other change concerns systems with an 8080 or 8085 processor, rather than a Z-80. These users must change the line assembled at 0312hex from the block move, EDB0, to a small routine which will move each of the 32 bytes individually. M

(listing continued from page 99)

```
0130 003F3F3F3F3F DB 0, '?????????'
013C 0000000000 DW 0,0,0,0,0,0,0,0,0,0,0,0
;
;
0152 00 FCB$COUNT DB 0
0153 AE03 FCB$LOCATION DW FCB$BUFFER
0155 00 FILE$COUNT DB 0
0156 00 FILE$TOTAL DB 0
0157 0000 OLD$SP DW 0
0159 STACK DS 32
0179 = STACK$TOP EQU $
;
;
0179 2020202041M1BUFFER DB ' A P H SECURITY SYSTEM$'
0194 2020202045M2BUFFER DB ' ENTER YOUR PASSWORD. >*'
01AF 2020444952M3BUFFER DB ' DIRECTORY CLOSED - NO ACCESS.$'
01CF 2020444952M4BUFFER DB ' DIRECTORY OPEN - CONTINUE.$'
01EC 20204F5045MXBUFFER DB ' OPENING DIRECTORY - PLEASE WAIT.$'
020E 2020202020 CONT DB ' $'
021B 2020534F52M1BUFFER DB ' SORRY - NOT A VALID PASSWORD.$'
;
;
; subroutine CRLF sends a CR/LF
; to the console.
;
023B C5D5E5 CRLF PUSH B! PUSH D! PUSH H
023E 0E02 MVI C, PRINT$CHAR
0240 1E0D MVI E, ODH
0242 CD0500 CALL FDOS
0245 0E02 MVI C, PRINT$CHAR
0247 1E0A MVI E, OAH
0249 CD0500 CALL FDOS
024C E1D1C1 POP H! POP D! POP B
024F C9 RET
;
; BEGIN is the start of the main
; program. The stack is set up
; and disk system reset.
;
0250 210000 BEGIN LXI H, 0
0253 39 DAD SP
0254 225701 SHLD OLD$SP
0257 317901 LXI SP, STACK$TOP
025A 0E0D MVI C, DISK$RESET
025C CD0500 CALL FDOS
;
; introduction message and
; instruction to type password is
; printed at the console using
; PRINT$CONS primitive and CRLF.
;
025F CD3B02 CALL CRLF
0262 CD3B02 CALL CRLF
0265 CD3B02 CALL CRLF
0268 0E09 MVI C, PRINT$CONS
026A 117901 LXI D, M1BUFFER
026D CD0500 CALL FDOS
0270 CD3B02 CALL CRLF
0273 CD3B02 CALL CRLF
0276 CD3B02 CALL CRLF
0279 0E09 MVI C, PRINT$CONS
027B 119401 LXI D, M2BUFFER
027E CD0500 CALL FDOS
;
; users response is read into
; INPUT$BUFFER using READ$CONS
; primitive.
;
0281 0E0A MVI C, READ$CONS
0283 110301 LXI D, INPUT$BUFFER
0286 CD0500 CALL FDOS
;
; Actual password at PASSWORD is
; compared with that input by the
; user. If correct move to DONEIT,
; otherwise to WRONG.
;
0289 210501 LXI H, INPUT$BUFFER + 2
028C 112401 LXI D, PASSWORD
028F 1A LDAX D
0290 4F MOV C,A
0291 13 INX D
0292 1A PWLP1 LDAX D
0293 47 MOV B, A
0294 7E MOV A, M
0295 8B CMP B
0296 C2A202 JNZ WRONG
0299 23 INX H
029A 13 INX D
029B 0D DCR C
029C CAC102 JZ DONEIT
029F C39202 JMP PWLP1
;
; Password is not valid. Directory
; will remain closed. Message is
; printed at console using
; PRINT$CONS primitive, and control
; jumps to terminating section FEND.
;
02A2 CD3B02 WRONG CALL CRLF
02A5 CD3B02 CALL CRLF
02A8 0E09 MVI C, PRINT$CONS
02AA 111B02 LXI D, M1BUFFER
02AD CD0500 CALL FDOS
02B0 CD3B02 CALL CRLF
02B3 CD3B02 CALL CRLF
02B6 0E09 MVI C, PRINT$CONS
02BB 11AF01 LXI D, M3BUFFER
02BB CD0500 CALL FDOS
02BE C3A703 JMP FEND
;
; Password is valid. Directory will
; be restored. Message is printed
; to console overwriting password.
;
02C1 0E02 DONEIT MVI C, PRINT$CHAR
02C3 1E0D MVI E, ODH
02C5 CD0500 CALL FDOS
02C8 0E09 MVI C, PRINT$CONS
```

(continued on page 103)

LONDON COMPUTER CENTRE



TOMORROW'S COMPUTING TODAY

ACT
SIRIUS 1

+ Z 80 CP/M Add on board (At no extra charge)

All CP/M 8 bit or 16 bit Software can be used **£2395**

Wordstar Magic Wand Spellbinder
Spellstar D Base II T/Maker Calcstar
Milestone Datastar Microstar
Fortran Cobol Pascal or any CP/M software

16 bits for the price of 8 bits
128K RAM
1.2 Mb Disk Storage

TELE-VIDEO SINGLE-USER TO MULTI-USER
NOW UPGRADED NO EXTRA CHARGE



802E 100K EXTRA DISK STORAGE **£2170**

Superbrain compatibility
Faster disk access
Green Screen. True descenders
22 Function Keys
802DE 2 Mb Disk Storage **£2295**
802HDE 14 Mb Hard Disk 1 Mb Floppy **£3990**
806 6 User 10 Mb Hard Disk **£4095**
816 16 User 23 Mb Hard Disk **£7385**
800 64K User Station **£1025**

Prices above based on exchange rate \$2 = £

800 64 K user station **£1025**



HARD DISKS

for Superbrain,
TRS 80 Model II, Apple
Model 6 6M/b **£1860**
Model 12 11.5M/b **£2295**

NEW

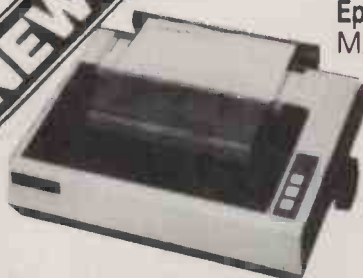

Epson Type 3
MX 80/FT
MX 100

NEW



New Superbrain 2
from **£1595**
Dedicated Wordstar Keypad

AUTO SHEET FEEDER

£580
New! 12" Wide
Automatic
Sheet Feeder
fits all below



AUTHORISED TANDY DEALERS

Model I
48K System
2 Disk Drives
Green Screen
Complete **£995**

Model II
with TRS DOS
and CPM at
no extra charge
from **£1995**

Model III
16K **£599**
48K **£649**
48K with 2 disk
drives **£1395**



DAISY WHEEL PRINTERS LETTER QUALITY PRINTING

- * FLOWRITER RP 1600. 60 CPS The most intelligent Daisy. Proportional spacing with Right Justification on
- * WORDSTAR, WORDPRO, APPLE WRITER SCRIPSIT etc. **£1500**
- * Olivetti ET 121. 20 CPS. Doubles as typewriter **£795**
- * TEC 40. 40 CPS. JAPANESE DIABLO 630 uses Diablo Daisy Wheel & Ribbons. **£1135**
- * DAISY WHEEL II 60 CPS. RICOH 1600 Daisywheel **£1050**
- * NEC. 35 CPS **£1250**
- * FUJITSU 80 CPS. Plastic/Metal wheels **£1695**

Save **£300** on this LCC Software Starter Pack

Wordstar	£250
Wordstar Trainer Manual	£ 25
Dbase II	£350
Supercalc	£175
	£800
Special Package Deal	£500
Saving £300	

All prices are Exclusive of VAT and Delivery. Dealer Enquiries invited on all Products.
Large range of CPM Software available. Please phone for Prices.

Demonstrations on all models.

43 GRAFTON WAY, LONDON W1P 5LA (Opposite Maples)
OPENING HOURS: 11-7 MON-FRI 12-4 SAT Tel: 388 6991/2
24 hour answer phone: 01-388 5721

(continued from page 101)

```

02CA 11EC01    LXI D, MXBUFFER
02CD CD0500    CALL FDDS
02D0 CD3B02    CALL CRLF
02D3 CD3B02    CALL CRLF
02D6 CD3B02    CALL CRLF
                ;
                ; FDDS primitives MATCH*1ST and
                ; MATCH*NEXT are used to bring
                ; the FCB for each file on disk
                ; into the disk buffer at 0080H.
                ;
02D9 0E11      MVI C, MATCH*1ST
02DB 113001    DITLPI LXI D, FCB
02DE CD0500    CALL FDDS
02E1 FEFF      CPI 255
02E3 CA1E03    JZ ALL*MATCH
                ;
                ; If 255 is returned from FDDS
                ; in reg. A, then no files are
                ; left on disk which match the
                ; filename in our FCB. This
                ; must mean no files remain as
                ; our FCB will match any filename.
                ;
02E6 0601      MVI B, 1
02E8 0F        RRC
02E9 D2ED02    JNC NO*LSB
02EC 04        INR B
02ED 0F        NO*LSB RRC
02EE D2F302    JNC NO*NSB
02F1 04        INR B
02F2 04        INR B
02F3 216000    NO*NSB LXI H, DIRECTORY - 20H
02F6 112000    LXI D, 20H
02F9 19        FCBLPI DAD D
02FA 05        DCR B
02FB CA0103    JZ FCBSET
02FE C3F902    JMP FCBLP1
                ;
                ; When here, reg H contains the
                ; RAM location of the start of
                ; the FCB for the next file in
                ; the directory.
                ;
0301 3A5201    FCBSET LDA FCB*COUNT
0304 3C        INR A
0305 325201    STA FCB*COUNT
0308 E5        PUSH H
0309 2A5301    LHLD FCB*LOCATION
030C E5        PUSH H
030D D1        POP D
030E E1        POP H
                ;
                ; Now move the 32 bytes starting
                ; at the location in H, to the
                ; buffer area starting at the
                ; location in D. Thus the whole
                ; FCB for the next file is moved
                ; to the buffer FCB*BUFFER, the
                ; current start location of which
                ; is held in FCB*LOCATION.
                ;
                ; This section cheats, using the
                ; Z80 block transfer code ED 80
                ; to move the FCB. This must be
                ; modified if 8080 CPU is used.
                ;
030F 012000    LXI B, 32
0312 ED80      DB OEDH,0B0H
0314 D5        PUSH D
0315 E1        POP H
0316 225301    SHLD FCB*LOCATION
0319 0E12      MVI C, MATCH*NEXT
                ;
                ; One FCB has now been moved to
                ; the buffer. Update the buffer
                ; and file pointers and jump
                ; back to the start of this loop
                ; at DITLPI, to move next FCBs.
                ;
031B C3DB02    JMP DITLPI
031E 3A5201    ALL*MATCH LDA FCB*COUNT
                ;
                ; when here, FCB*BUFFER contains
                ; a valid FCB for each file on
                ; the disk. Each FCB is 32 bytes
                ; not the full 33 as the current
                ; record field is not required.
                ;
                ; Now insert nulls into all
                ; unused FCB fields. Then move
                ; the upper case equivalent of
                ; the lower case filename in the
                ; first 16 bytes into the second
                ; 16 bytes. This simply involves
                ; subtracting 20H from the ASCII
                ; values.
                ;
0321 325601    STA FILE*TOTAL
0324 21AE03    LXI H, FCB*BUFFER
0327 11BE03    LXI D, FCB*BUFFER + 16
032A 0E0B      SUBLPO MVI C, 11
032C 3E00      MVI A, 0
032E 12        STAX D
032F 23        INX H
                ;
0330 13        INX D
0331 7E        SUBLPI MOV A, M
0332 FE20      CPI ' '
0334 CA3E03    JZ NOSUB
0337 FE5A      CPI 5AH
0339 FA3E03    JM NOSUB
033C D620      SUI 20H
033E 12        NOSUB STAX D
033F 23        INX H
0340 13        INX D
0341 0D        DCR C
0342 C23103    JNZ SUBLPI
0345 3E00      MVI A, 0
0347 0E04      MVI C, 4
0349 12        NSLP STAX D
034A 13        INX D
034B 23        INX H
034C 0D        DCR C
034D C24903    JNZ NSLP
                ;
                ; One FCB is now in the right
                ; format for use with RENAME
                ; primitive. If all FCBs have
                ; been processed proceed to
                ; renaming section, else jump
                ; back to start of loop after
                ; updating pointers etc.
                ;
0350 3A5201    LDA FCB*COUNT
0353 3D        DCR A
0354 CA6803    JZ RENAME
                ;
                ; Pointers will point to next FCB.
                ; Then jump back to SUBLPO
                ;
0357 325201    STA FCB*COUNT
035A 011000    LXI B, 16
035D 09        DAD B
035E E5        PUSH H
035F D5        PUSH D
0360 E1        POP H
0361 09        DAD B
0362 E5        PUSH H
0363 D1        POP D
0364 E1        POP H
0365 C32A03    JMP SUBLPO
                ;
                ; Now use RENAME primitive with
                ; each FCB in the buffer to
                ; rename each file with its old
                ; upper case name. More nulls
                ; are added as required first.
                ;
0368 3A5601    RENAME LDA FILE*TOTAL
036B 21AE03    LXI H, FCB*BUFFER
036E E5        RENLPI PUSH H
036F 010C00    LXI B, 12
0372 1E02      MVI E, 2
0374 09        STLP DAD B
0375 1604      MVI D, 4
0377 3E00      MVI A, 0
0379 77        LP MOV M, A
037A 23        INX H
037B 15        DCR D
037C C27903    JNZ LP
037F 1D        DCR E
0380 C27403    JNZ STLP
0383 D1        POP D
0384 D5        PUSH D
0385 0E17      MVI C, RENAMEF
0387 CD0500    CALL FDDS
                ;
                ; A file has been renamed. Update
                ; pointer to next FCB, and the
                ; file counter. Jump back to start
                ; of loop at RENLPI if more files
                ; have yet to be renamed.
                ;
038A E1        POP H
038B 112000    LXI D, 32
038E 19        DAD D
038F 3A5601    LDA FILE*TOTAL
0392 3D        DCR A
0393 325601    STA FILE*TOTAL
0396 C2AE03    JNZ RENLPI
                ;
                ; All files are now renamed. Print
                ; a final message to console.
                ;
0399 CD3B02    DONREN CALL CRLF
039C CD3B02    CALL CRLF
039F 0E09      MVI C, PRINT*CONS
03A1 11CF01    LXI D, M4BUFFER
03A4 CD0500    CALL FDDS
                ;
                ; Terminate program by restoring
                ; stack to original state and
                ; jumping to CP/M boot location.
                ;
03A7 2A5701    FEND LHLD OLD*SP
03AA F9        SPHL
03AB C30000    JMP 0000H
                ;
                ; FCB*BUFFER starts here as its
                ; length is dependant upon the
                ; number of files on the disk,
                ; and so will vary.
                ;
03AE =        FCB*BUFFER EQU *
03AE          END 100H

```

PRINTERS

SEIKOSHA GP100

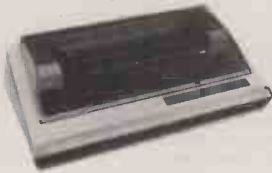

New Design unbelievably low price printer

80 columns. 30 cps 5 x 7 dot matrix. Adjustable tractor up to 10 ins. Graphics. double & standard width printing. Parallel interface as standard. RS232, Apple, IEEE & TRS-80 interface options.

£215

EPSON MX-80 F/T SERIES



Probably the most popular printer in the world.

Type I: 80 cps bidirectional printing logic seeking, 9 x 9 matrix with true descenders. 3 way paper handling. 80 columns with condensed emphasised & enlarged characters. FF, VT & HT. Parallel interface.

Type II: has programmable form feed & line spacing. Bit image printing.

MX80 FT £399 MX8 FT TYPE II £445

OKI MICROLINE 80, 82A & 83A.



Compact Printers.

80: Unidirectional 80 cps Parallel interface, pin & friction feed.

82A: Bidirectional 80 cps Parallel & serial interface

83A: Bidirectional 120 cps 15 ins 132 cpl at 10 cpi. Parallel & serial interfaces. Graphics & fast serial interface options.

ML-80 £325 82A £465 83A £880

EPSON MX-80T SERIES

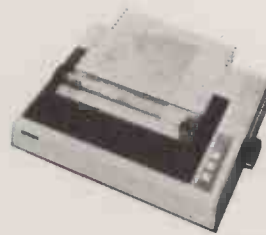

Low Cost, High Quality. Adopted by PET, HP, IBM, Sharp.

MX-80T: Bidirection, logic seeking. 180 cps. 9 x 9 matrix with true descenders. 80 cols. Adjustable pin feed. Normal condensed & enlarged characters. FF, VT, HT Parallel interface.

Type II: has programmable form feed & line spacing. Bit image printing.

MX80-T £360 MX80-T TYPE II £399

TEC STARWRITER



Best-Buy Daisy Wheel Printer.

Bi-direction. 25 cps. Low cost supplies. Standard Daisy Wheel. Carbon and fabric ribbons. Parallel or RS232 interface. Sheet feeder options.

£799

EPSON MX-82 & 100

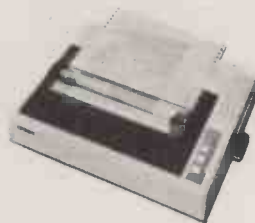

High Resolution Low cost.

MX-82: As MX-80 spec. plus programmable line spacing & form feed. Bit image printing.

MX-82 F/T.: Adds friction feed.

MX-100: As MX-82 FT with 15½ ins. carriage.

MX-82 £415 MX-82 F/T £455 MX 100 £575

ANADEX DP-9000 RANGE



High Quality Fast, Versatile Printer.

Six models. Up to 15 inch paper width. Lower case descenders. 160-220 cps bi-directional printing. RS232 current loop & parallel interface. X on X off. Optional 2K buffer. Multiple print densities. Fast print of high-density bit image graphics.

DP-9000L £747 DP-9001 £888 DP-9500 £935
DP-9000 £841 DP-9500L £841 DP-9501 £982

FROM

RIVA

RIVA TERMINALS LTD.

Head Office: 9, Woking Business Park
Albert Drive, Woking, Surrey GU21 5JY
Tel: Woking (04862) 71001 Telex: 859502

Northern Office: Tel: Harrogate (0423) 503867
Scottish Office: Tel: Strathaven (0357) 22678

• Prices exclude VAT

• Circle No. 160

It is a waste of time to try and prove that programs are correct by using mathematical or logical proofs, argues Boris Allan. What matters is whether they work, and you can only discover that by running them.

Searching for truth

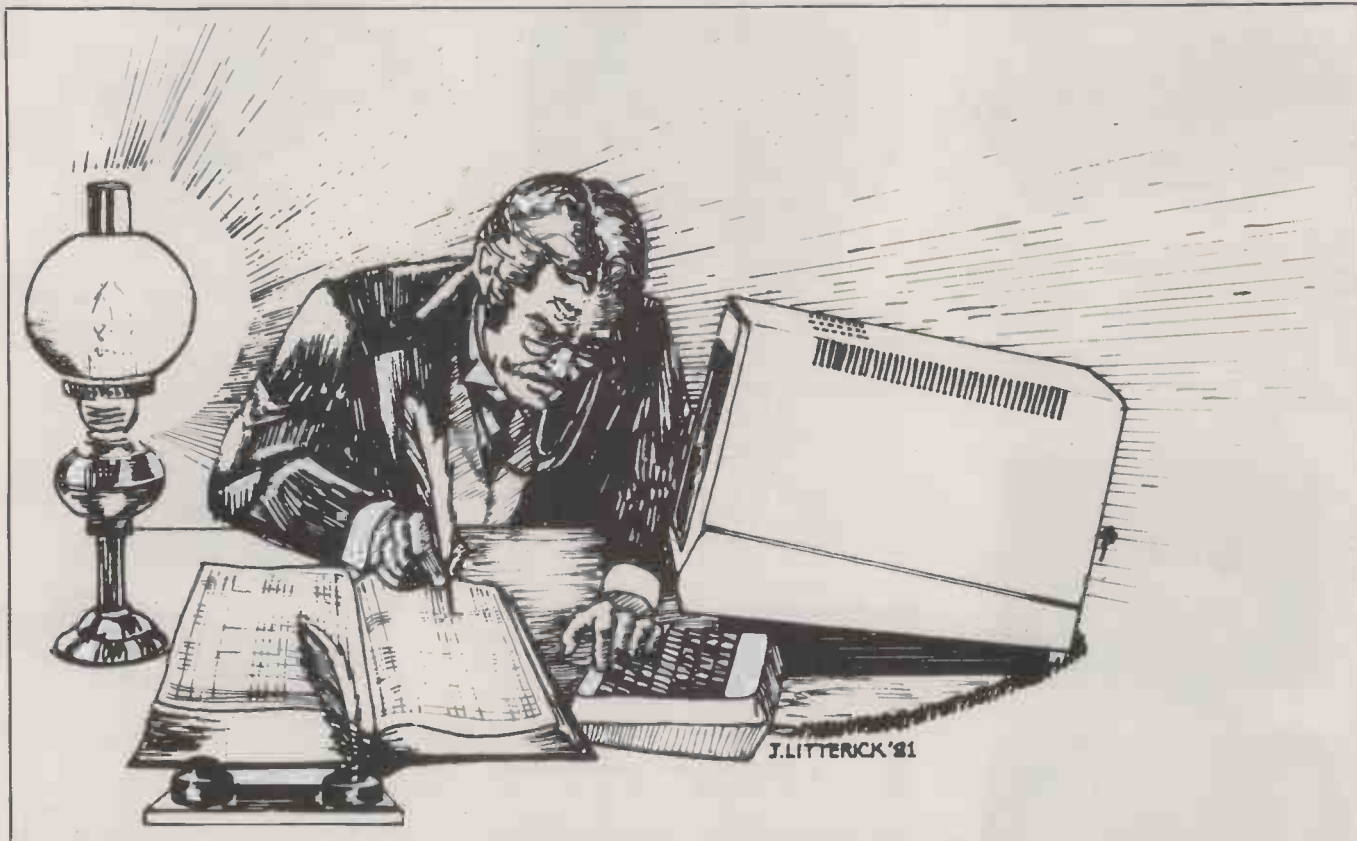

IT IS NOW realised that a scientific theory can never be given more than a provisional acceptance, one can only say that it has been "found to be true so far". Such provisional acceptance must be based on attempts to falsify the theory. It is only too easy to find confirmations of a theory; efforts should be directed towards trying to prove the theory wrong rather than making a vain attempt to prove it right.

This attitude to testing is generally associated with the name of Karl Popper. Though some of Popper's other ideas are the subject of a debate, the notion of falsification is relatively non-controversial. An implication of this approach is that you can never show a theory or hypothesis to be true, while a single disconfirming instance — an error in a prediction — shows that the theory or hypothesis is untrue.

In recent years theoretical computer scientists have expended much time, work and energy, on "proving programs correct", using purely mathematical and logical methods. Yet it is impossible to prove that a program is correct merely by testing it, as a famous quote from

Dijkstra clearly states: "Program testing can be used to show the presence of bugs, but never to show their absence".

It is hoped that if a program is proved to be "correct" by mathematical means you can be assured of no errors or, in the jargon, no bugs. The use of these methods has a powerful appeal. The recent text by Linger and others declares: "The new reality [of programming] is that you can learn to consistently design and write programs that are correct from the beginning and that prove to be error-free in their testing and subsequent use".

Known by the soubriquet "structured" programming, there now exists a well-established approach to programming in which proofs of correctness play an important role in teaching the student programmer. To program in a structured manner does not require a knowledge of correctness proofs. Outside the confines of computer studies, most so-called structured programming is nothing but systematic or modular programming under another name.

It is worth being explicit about what is promised:

a. it is impossible to prove that a program is

correct merely by testing the program, though testing may reveal that the program is incorrect.

b. it is possible to prove that a program is correct by mathematical means.

A program is an answer to a question and, in science, answers to questions set by nature are called "theories". A computer program is a theory or hypothesis of how a computation should be; the execution of a program is the test of the theory — analogous to an experiment.

If the promises about correctness proofs for programs are written with the term "theory" in the place of "program" then you find:

a. it is impossible to prove a theory correct by testing the theory, though a theory can be shown to be incorrect;

b. it is possible to prove that a theory is correct by purely mathematical means.

Consideration "a" is the "Popperian falsificationist" position, but "b" is patently untrue — you can establish internal consistency by mathematical means, but never external truth. That a program or theory is internally consistent may mean that the program or theory is less likely to be false; reality is the ultimate arbiter,

(continued on page 107)

WINDOW SHOPPING?

then look no further! we offer a range of quality hardware and software.



TEC STARWRITER EXECUTIVE 40

A superior daisy wheel printer suitable for most micro's and mini's costing less than you'd expect achieving professional results in all applications. Bi-directional logic seeking Printing, 40CPS. Quiet operation. Easy change 96 character daisy wheel. Carbon multi-strike or fabric ribbons. 1 year warranty. 1



NORTH STAR ADVANTAGE

North Star's latest desk top computer. The Advantage is an integrated graphics computer that is equally suited to both business and scientific use. Advanced features include dual processors, and high resolution graphics display. The Advantage contains a 4 MHz Z80A CPU with 64Kb of 200 nsec dynamic RAM (with parity) for program storage, a separate 20Kb 200 nsec RAM to drive the bit-mapped display, a 2Kb bootstrap PROM and an auxiliary Intel 8035 microprocessor to control the keyboard and floppy disks. The two integrated mini-floppy drives are double-sided, double-density providing storage of 360Kb per drive for a total of 720Kb. Inside the chassis is a eight slot mini-bus for plug-in option cards. Included with the Advantage system is a system diskette containing a Business Graphics package, a complete system diagnostic program and a graphics demo. package. The serial printer port is graphics software compatible with Epson printers, making it easy to produce a hardcopy of the screen. For a wide variety of commercial, scientific or industrial applications North Star's graphics version of the industry standard CP/M is offered.



EPSON MX82 F/T

A first class compact dot-matrix printer with high resolution bit image graphics. Bi-directional logic seeking printing, 80 cps, quiet operation. Plotter printing.



INSIGHT VDT-6

A new, stylishly designed terminal for use with 'WORDSTAR', it features 31 special Wordstar function keys for higher performance word processing. 80 character x 24 line display with an enhanced contrast screen. Graphic line drawing mode. Detached keyboard with numeric pad. Full video attributes e.g. underline, reverse video, blinking. 16 independent baud rates for interfacing. The most competitively priced Wordstar VDU on the market.



TELEVIDEO TVI 910

Low cost fully intelligent terminal with many features as standard normally found as options on similar priced terminals. Typewriter tabs, monitor modes, programming features. 8 x 10 character resolution. Full video attributes. 15 baud rates.



NORTH STAR HORIZON HARD DISK

The highly regarded Horizon microcomputer with mini-winchester disk drive. This integral hard disk gives a massive 3, 6, 9, or 12 million character storage capacity. More intensive computing power sufficient for virtually all applications. For further capacity, up to four M26 Winchester hard disks can be added externally giving access to over an incredible 100 million characters of data. Using Starlink our enhanced CP/M compatible multi-user operating system this data can be accessed by one or more users in a time sharing or multi-processing environment. Starlink is at the heart of system expansion. Starlink logically integrates the Horizon with a range of Winchester disks and/or additional I/O, memory and processors. Features include independent login and logout, print spooling, file lock and unlock for common files, five priority levels, two-way private communications, mail/news/message facilities etc. In all over 20 utilities are incorporated in the Starlink package.



RICOH RP1600S

Fast and reliable making it suitable for todays word processing demands. Its heavy duty construction will stand up in harsh working environments. Bi-directional, logic seeking, 65 cps. Options include Tractor feed, automatic sheet feeder.



INFO SCRIBE 1000

A slickly styled inexpensive dot matrix printer suited to small business and minicomputer systems. Hard to beat low noise performance, touch-sensor controls, and exceptional speed are definite advantages of this printer. Bi-directional logic seeking printing, 180CPS. Low speed correspondence quality printing mode. Double density printing. Double wide printing. 96 characters. Descenders and underlining. Tractor feed included as standard.

INTEDAM

Microcomputer Specialists

46 Balham High Road London SW12 9AQ Tel: 01-675 5325

Name: _____
 Position: _____
 Company: _____
 Address: _____
 Tel No: _____
 PLEASE SEND ME DETAILS OF THESE AND OTHER PRODUCTS

● Circle No. 161

The neglect of the consequences of induction is a key flaw in structured programming, particularly in the proving of program correctness. Techniques for proving program correctness have been held out as a means by which totally correct programs can be written, before the programs are even run on a computer.

The argument may be summarised as follows:

- It is impossible to prove a program is totally correct, by any means.
- Proponents of structured programming have confused verification, proving correct, with falsification or trying to prove incorrect.

- Methods of proving program correctness are merely methods of establishing program consistency — in itself no bad thing.
- Methods of proving program correctness are based on a method, induction, whose own correctness cannot be proven.
- Conventional mathematical methods do not work when you consider computations for floating-point numbers on a real computer.
- There can be no escape from the actual execution of a program on a computer — in fact the same program might be correct on one computer but not work at all on another.

(continued from page 105)

however, as the program, or theory, must at some point match reality.

It is not possible to prove programs correct by testing, only correct so far, though this is all that can be said of any scientific theory — only correct so far. If the necessity for any reference to reality is eliminated for programming, then science would have difficulty in following this pattern. In the case of a computer program, "reality" is the computer.

There are those who extoll the virtues of correctness proofs even to the extent of designing computer languages to facilitate such proofs. They have missed the point. No theory can ever be proven to be

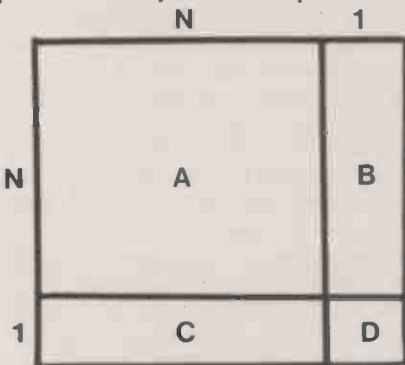

correct, though it is possible that a theory may be proven to be consistent. Even then it is usually only trivial theories that afford such a proof, classical mechanics, for example. Proofs of consistency have been confused with proofs for "correctness". Anderson provides a simple introduction to correctness proofs.

The question of the proof of theories is tied up with the general question of induction. A theory can never be proved correct purely on the basis of past experience, however formal the past experience. Will the sun rise tomorrow?

How do the supporters of correctness proofs think they have circumvented the problem of induction? First, consider what is a "proof". If

$$F(N) = (N+1)^2$$

then simple algebra suggests that also

$$F(N) = N^2 + 2N + 1$$

turning this argument into a proposition $P1(N)$,

$$P1(N): F(N) = (N+1)^2 \equiv F(N) = N^2 + 2N + 1$$

The question arises, how would the process of proof for $P1(N)$ progress?

Those who have a strong visual imagery might think of a square with side $N+1$. Within it shape A has an area N^2 , B and C both have area N , and D has an area of 1 unit. The area of the square of side $N+1$ is $(N+1)^2$. It is equal to the sum of the areas $A+B+C+D$, which is $N^2 + 2N + 1$. $P1(N)$ is thus proven correct.

A critic of this process of proof might then ask to be shown that the shape A, an N -by- N square, really has an area of N^2 . The process of clarification and proof could be pushed further and further — like that annoying child's question "Why?" — and the critic still need not be satisfied. Only if the critic is "sensible" and displays some goodwill is the first diagram likely to suffice. Mathematical proof is based on goodwill.

Suppose the correctness of $P1(N)$ is demonstrated by

$$\begin{aligned} (N+1)^2 &= (N+1)(N+1) \\ &= N(N+1) + 1(N+1) \\ &= N^2 + N + N + 1 \\ &= N^2 + 2N + 1 \end{aligned}$$

and this is the "proof". The critic says, "Fine, you have played with letters and numbers according to your rules, but prove it". A number is substituted for N — say, 0 — so that

$$(N+1)^2 = (0+1)^2 = 1$$

and

$$N^2 + 2N + 1 = 0 + 0 + 1 = 1$$

References

- R B Anderson, *Proving Programs Correct*, John Wiley, New York (1979)
- E W Dijkstra, "Notes on Structured Programming" in *Structured Programming* by O-J Dahl, E W Dijkstra and C A R Hoare; Academic Press, London (1972)
- R C Linger, H D Mills and B I Witt, *Structured Programming: Theory and Practice*; Addison-Wesley, Reading Massachusetts (1979)
- B Magee, *Popper*, Fontana, London (1973)
- J Passmore, *Philosophical Reasoning*; Duckworth, London (1970)

thus the proposition $P1(0)$ is correct.

The critic now says "It is true for $N=0$, but what about other numbers"? Even when every substitution for N shows $P1(N)$ to be correct the critic may remain unconvinced. An appeal has to be made to the critic's goodwill, to "see", by induction, that $P1(N)$ is true. Yet $P1(N)$ need not necessarily be true for transfinite numbers.

The goodwill is codified as a standard method of proof called mathematical induction, which in its simplest form is as follows:

- a. prove $P1(0)$ is true;
- b. prove that if $P1(N)$ is true then $P1(N+1)$ is necessarily true.

It is intuitively clear that, by induction, "a" and "b" together provide a proof of $P1(N)$ for all positive values of N , and with goodwill this can be accepted as proof. From the earlier discussion it can be seen that "b" is as open to query as any other proof. For example, it can be said "So it is true for N and $N+1$, but what about $N+2$ ".

In advanced work you have to assume the process of proof with equivalents to "a" and "b" as axioms. That mathematical induction is true cannot be proven, so methods of induction whose correctness cannot be proven are used to prove the correctness of programs. See Passmore's book which includes a general discussion of induction.

Mathematical reasoning can be perfectly valid as mathematical reasoning but need not be valid as practical reasoning. Examine proposition $P2(*)$

$$P2(*): *y = *z \equiv y = z$$

which reveals an old chestnut. If $* = 1$ and $y = 2$ then

$$1 \times 2 = 1 \times 2$$

so that $z = 2$ and thus $y = z$. However, if $* = 0$, and $y = 2$, then $0 \times 2 = 0 \times z$ so that z may be any finite value: we have ourselves resorted to the critic's stance.

Mathematically, we could say $P2(*)$ is true for all values of $*$ other than zero, but on a computer $P2(*)$ is not true for all values of $*$ other than zero. If $*$ lies between $\pm 1E-38$, on most computers then $*$ is taken to be zero; the computer is a finite machine.

On a computer, if $*/2 = 0$ then either $*$ is zero or $*$ is equal to the smallest value which that computer regards as being distinct from zero. These kinds of arguments may explain why discussions of correctness proofs for floating-point as against integer numbers do not exist.

Perhaps this may also explain why scientific users have been slow to move to "structured" languages and have remained with a very old language, Fortran. Scientific users are mainly interested in computations on floating-point numbers, whereas with some "structured" languages, especially variants of Pascal, the use of floating-point numbers seems to be an afterthought. □

Putting across your message in print

In order to achieve success, it is worth spending some time and effort to make sure that the words and pictures used in promoting your product are right for the job, writes Clive Wilkins.

STEVEN JOBS started Apple on the basis of having a good technical idea and has made himself a multi-millionaire by the age of 25. It is not surprising therefore that many others should want to follow suit. Technical expertise is to be found in abundance in the UK to produce a good crop of micro-products. But will they continue to sell? This depends partly on the quality of the products but crucially on whether or not there is sufficient marketing expertise to give them the start they need to build success. In many cases it is this element that is sadly lacking.

Microcomputer products are low priced and in general are not sold in bulk to end users. This means that employing salesmen is just not on for much of the market and the products have to be sold through response advertising or direct mail. In these cases, all the burden of putting across the sales message and getting the customer to sign is placed on the written word. In view of the importance to the future success of the product, it is worth spending some time and effort making sure that the words and pictures used are right for the job they have to do.

In function a piece of promotional literature is identical to a salesperson — it exists to achieve sales. This means it must

- grab prospective customers' attention
- stimulate their interest
- create a desire for the product
- initiate their action to buy

Before any of this can be done, there must be a very clear idea of who the

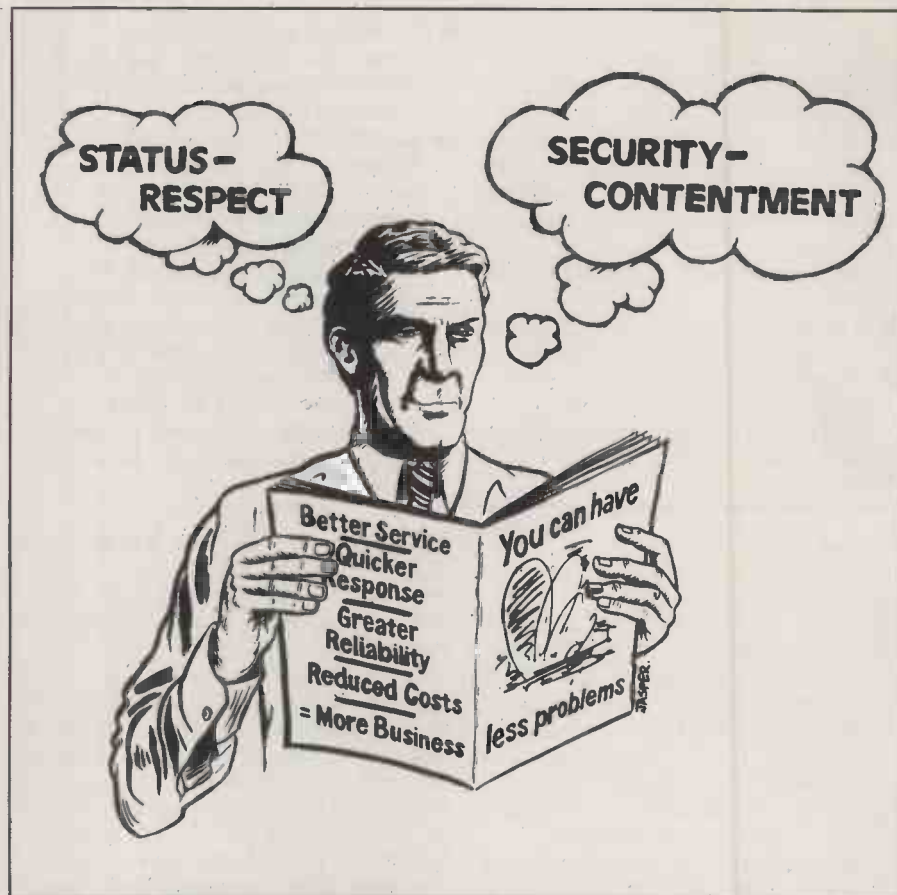

Figure 1. Meeting the prospect's needs.

prospective customers are, where they are, and what sort of needs they have. If writing the promotional materials causes these questions to be asked for the first time then there is something seriously wrong. They should have been asked before the product was developed in the first place.

Step one in producing publicity literature is to get out of the habit of thinking about the product and to think instead about the customers or prospects. It is all too easy to fill an advert with features of the hardware or software instead of thinking about how it answers the prospects' needs. People do not buy features — they buy answers to their needs.

A list of needs

Fundamentally, it boils down to needs like being content and secure, having status and being respected. No one is going to be content if it turns out that they have bought a piece of your hardware or software that does not work. The publicity must assure them that the product will not cause problems. This does not necessarily emerge from a list of features. Similarly, anyone buying hardware or software that can be proved to have saved money, or improve efficiency, will enhance their own status and the degree of respect they receive. The publicity must show how this can happen.

So before rushing into print, step aside and produce a list of needs which the prospects have and which the product can

meet. Try to think about these from the customers' point of view.

It is no use, for example, saying that a payroll package meets the need to do payrolls. If the customers were honest their real need is not to do payrolls at all — they cost money and do not contribute to profit. As they cannot have this wish fulfilled, the next best is to get the payroll done with minimum fuss and this means quickly, easily, cheaply, accurately, reliably and regularly. These are the needs that a payroll package must meet.

Just by thinking about customer needs, some words such as quick, accurate, reliable, are emerging which provide the essential pegs for the publicity text. The idea of user-needs also provides the basis for deciding what form of publicity to produce. The same rules apply to publicity literature and adverts.

Beware of people who begin "We need a brochure for this product. They have probably decided what form the publicity will take without having any idea how it is to be used. Producing publicity literature should be just part of a marketing plan.

It is impossible to design a brochure and then decide what to do with it though it is surprising how many companies achieve the impossible. The function of a brochure should be one of its major design criteria.

If someone asked you to write a program for this computer you would first ask what the program was to be used for. The same applies to sales literature. You

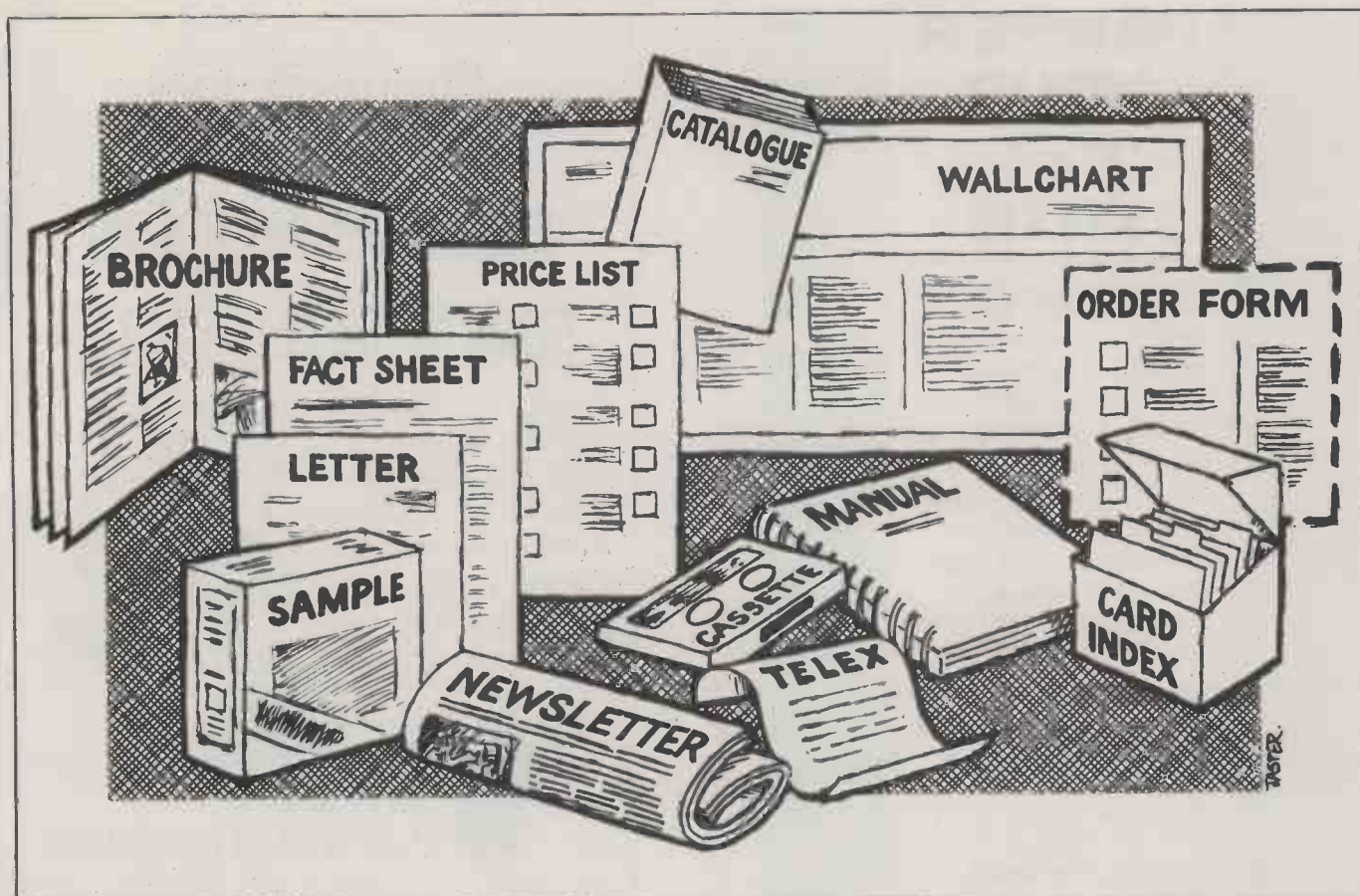

Figure 2. Forms of publicity material.

cannot design it without knowing what it is for, and how it is to be used.

Publicity literature can take many forms, some of them surprising to people with brochures on their minds.

If you are selling a wide range of cheap software then a typewritten stocklist with well thought-out copy describing each item is quite appropriate for the personal buyer to whom low cost is important. Similarly a folder containing fact sheets or case-history applications may be the right way to sell hardware to the naive user who is more interested in what the machine can do for him than technical details which he hardly understands anyway.

Importance of form

The form is of fundamental importance in determining how successfully the message is put across. A well thought-out low-cost solution may achieve infinitely more sales than a badly conceived expensive "brochure". Decide the function and the form before considering the contents.

Unless you are a design expert, you will probably get a qualified designer to produce the final version of your publicity material. Advertising agencies or graphic designers are often more concerned with appearances than function. So decide the balance of the contents yourself first, and then let the graphic designer advise you about the finer points of finished design and presentation.

Make a dummy of the finished article

out of plain paper and sketch the main elements of contents on each page. This gives a clear idea of the balance of the contents and determines the amount of copy needed. The designer can adjust the number of words on a page and the layout to best effect, but can only work within the limits of the specification given.

It is no use handing over 16 pages of hardware jargon and saying, "put this on half a page and give it plenty of impact". The designer can do his best but it is an impossible task. Make your choice at the design stage. Either allow enough space to put over the message — or if you only allow half a page then limit the number of words.

"Do not code until the design is right" is the golden rule of programming. "Do not write publicity copy until the design is right" is a golden rule of marketing. Putting pen to paper is much easier when you know the specification for the piece you are writing and how it fits into the overall pattern of things.

At this preliminary design stage graphics have to be considered — the photographs, diagrams, graphs and drawings that are to accompany the text. Graphics have a strong impact on the reader and have a large influence on the tone of the piece — technical, amusing, informative, startling, friendly — whatever. Just as the words have to reflect answers to user-needs so too do the pictures.

Ask not whether a graphic has impact value or relevance to the product — but does it put the message across? A busy female may have plenty of impact but unless her picture contributes to the message being put across it has no value. Worse, it may actually conflict with the message the customer wants to receive. Umpteen pictures of the same piece of hardware do not necessarily increase the customer's understanding or desire.

Keep diagrams simple

Diagrams can be a very useful shorthand for putting across a technical message, but if you want the customer to read them they have to be simple. A natural reaction from people who understand the product in detail is to think that every plus point must be included and that every single correct linkage must be shown. But we are trying to think of the customer — and there is a limit to how much information can be absorbed from one diagram. Above this limit, adding more detail reduces the amount of information that the reader receives.

At the extreme, an exceedingly complicated diagram receives only the briefest glance and the only message received by the reader is one of complication.

Designers' graphic ideas often mesmerise technical people. There is a danger of accepting the first idea that comes along because it looks original.

The trick is to keep asking "Would that
(continued on page 111)

PAMPER YOUR PET WITH

Codewriter[®]

Write your data base applications programs in a fraction of the time usually required.

Microsystems introduce to PET owners the CODEWRITER, a superb program generator for the 8000 series PET with dual disk drive unit.

Screen layout, data entry validation, screen display of user-defined error messages, screen calculations, searching by any field - all are child's play to Codewriter Disk 1.

Codewriter Disk 2 provides printed reports and menu generators.

Codewriter Disk 1 - £125.
Codewriter Disk 2 - £65.

Dealer enquiries welcome.

Pamper your PET promptly, write or 'phone for further information NOW!



C.O.R.P.[™] makes Apples more tempting

Apple, the most popular micro-computer, now has a Software accessory which enables the system to be programmed by beginners.

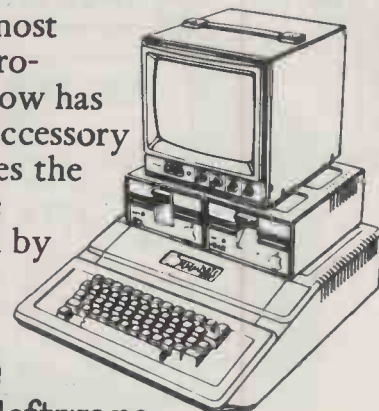

the  Software
C.O.R.P.[™] that writes programs

C.O.R.P. is the most advanced and comprehensive collection of program generators which writes Applesoft programs. It enables a beginner to program quickly, simply and error-free by himself in everyday language with no programming knowledge. It's the first usable educational package! Handbooks are supplied with every system. C.O.R.P. Master Disk (Data base/print program generator) - £125. Demo Tutorial - £25. Utilities Disk 1 - £75. Utilities Disk 2 - £29. Diagnostics Disk - £24. Complete system - £269. 48K Apple II, DOS 3.3 and 2 disk drives required. Ask for list of authorised dealers. Details of C.O.R.P. 'Turnkey Systems' available.

COME TO THE
MICROSYSTEMS
'TEACH-IN'
Courses now
available.

a Dynatec company

Details of C.O.R.P. and Codewriter from:
MICROSYSTEMS LIMITED
SUMMERFIELD HOUSE, SUMMERFIELD ROAD,
VALE, GUERNSEY, CHANNEL ISLANDS.
Telephone: 0481 47377
Telex: 4191130 (DYN MIC G)

*APPLE is a registered trademark of APPLE COMPUTER INC.
*C.O.R.P. is a registered trademark of the MAROMATY & SCOTTO SOFTWARE CORP.

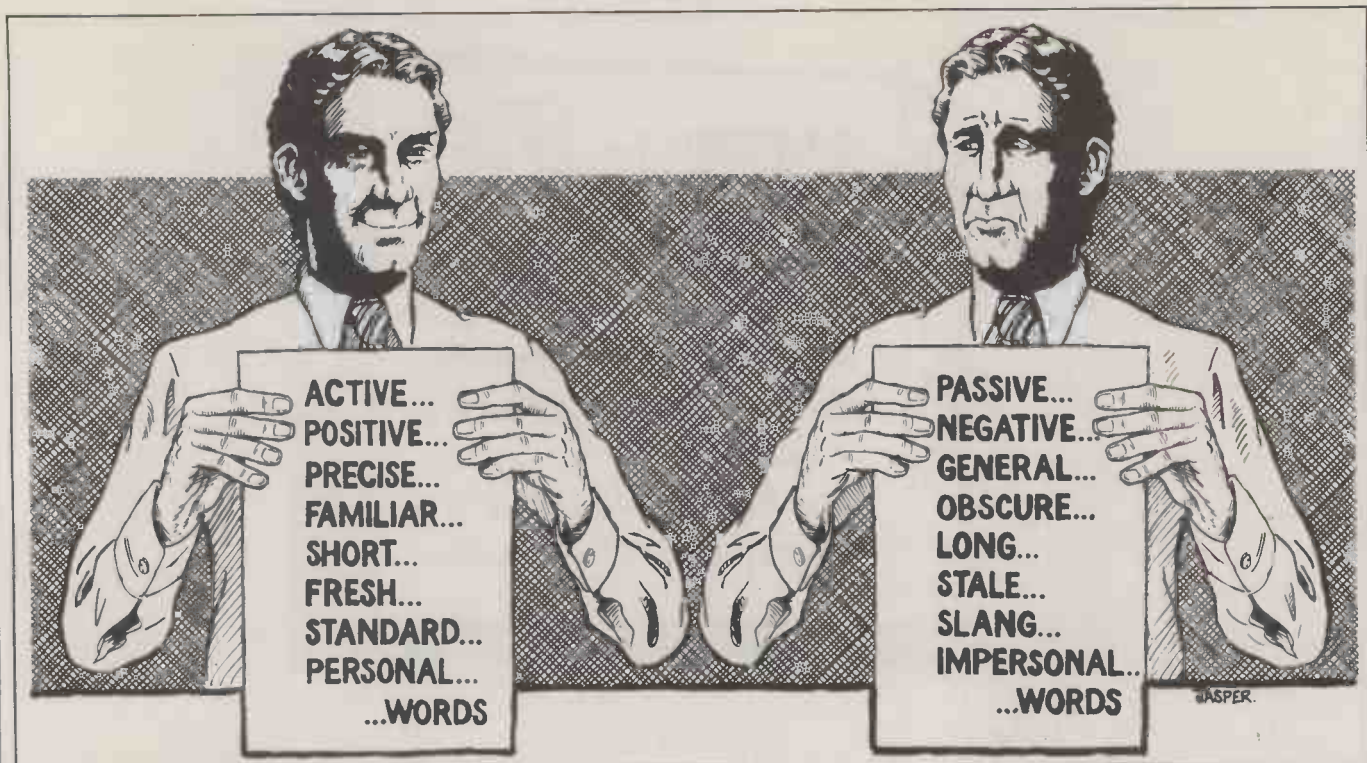

Figure 3. Good copy vs. bad copy characteristics.

(continued from page 109)

appeal to my needs if I were a customer"? Make the designer justify the design on this basis.

Copywriting is easy, but writing good copy is not. Even after a lot of practice, it always takes time and effort. You may feel disappointed that all you have to show for three or four hours of hard creative work is a paragraph of good copy, but when you see what one paragraph of good copy can achieve in sales, you will understand just how productive and valuable those hours of painful concentration were.

Copywriter's job

Armed with information on who the customers are, what their needs are, and how the product satisfies these needs, the copywriter's job is to:

- Remind or convince the prospects that they have needs
 - Explain how the product satisfies a need — explicitly by describing what the need is and implicitly in the way that the product is described
 - Convince the prospect that the product is the best way of satisfying the need
 - Persuade the prospect to place the order
- Any word of copy that does not contribute to one or more of these objectives must be ruthlessly expunged.

There is no easy way to turn average writers into brilliant copywriters but there are some simple tricks of the trade to help. First, words can be classified according to their characteristics as well as their meaning.

Sometimes words fall into contradictory categories. precise but long, personal but slang, and the copywriter has to decide whether the advantages outweigh the disadvantages. When in doubt the

rule is — always prefer the word that is alive and interesting over the word that is dull but safe.

I find it helpful to jot down useful words on a list and refer to them from time to time to help out when stuck or just to ensure that the copy has the right sprinkling of active words. In general the adjectives should come from the user-need statements derived in the design step.

Choose the first word of a paragraph with care. It is a prime position and worthy of a good, interesting word. Here is an example:

The right small-business computer could make you money.

This isn't bad copy but it would be livelier if it started with a more powerful word, for example:

You can make money from the right small business computer.

Good words to start the first sentence include:

You
If
(any number)
Now
But
And
Go (or any verb)
How/What/Where/Why . . . ?

Words that you should not use to start an initial sentence include:

The
It

A

Starting in this way makes the copy more lively and interesting to the reader — more likely to get your message across. Avoid burying the best words in the middle of a sentence or paragraph — give them a chance to shine. Do not be coy —

spit it out. In particular, try to avoid those yawn-producing openings:

It is becoming increasingly important . . .
In recent years there has been a growing tendency . . .

Copy should always follow the rules of English — spelling, grammar, punctuation etc. with allowable exceptions such as short sentences with no verbs. Following the rules is particularly important when selling to people with programming experience who are so used to the disastrous effects of mis-spelling or faulty punctuation in programs that errors leap out of the page at them even in ordinary English.

This article will not teach you grammar but there are one or two points that may help you get one up on your competitors.

(continued on next page)

Identifying the market.

What needs does the product meet?

More efficient stock control
Quicker order taking
More reliable payroll

Who has these needs?

Industry sectors: eg manufacturing/finance/
construction/local government
Particular types: eg estate agents/oil
companies/small batch manufacturers
Prospect's job title: eg personnel manager/
senior partner/management services
manager

How many prospects are there in total?

Total prospects of the type specified
— minus those you do not know how to find
— minus those you cannot afford to
contact
— minus those who are already happy with
what they have

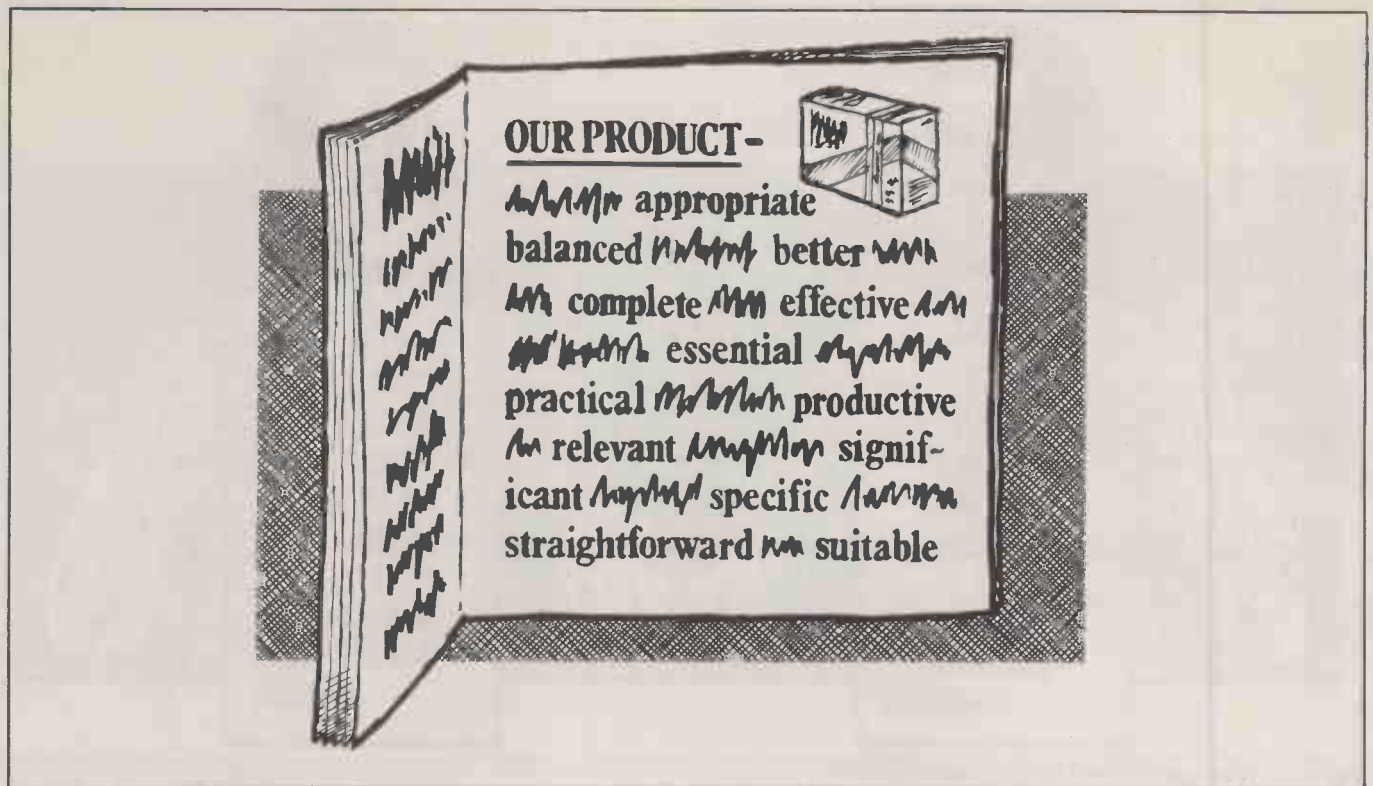

Figure 4. Some user-friendly adjectives.

(continued from previous page)

First, use the present tense whenever possible. Use "Our software gives you these benefits" rather than "Our software will give you these benefits" or "This personal computer produces 20 invoices a minute" rather than "will produce".

Second, be active rather than passive — "Take this opportunity . . ." not "This opportunity should be taken . . ."

Third, avoid negative constructs: "Get this package now", not "No one should avoid this opportunity of getting . . ."

Fourth, be consistent with names and technical terms. If you have described

your product as stock-control software in one place do not call it the stock-control program or stock-control package elsewhere.

Finally, be kind to the readers and coax them through the copy gently, giving them suitable headings to help them on their way. For example, make sure that in any continuous block of copy the level of copy is consistent.

Keep copy flow

Do not say "This computer system is the most sophisticated small computer for its price available today. The printer casing is painted an attractive green." This sort of jump in level is not uncommon and it is a ghastly experience for the reader. It is like flying into an air pocket. The difference in level hits you with a bang and stops your reading dead. Using conjunctions to start sentences can avoid discontinuities. And, but, so, — these are all words that link one sentence or thought with the next and, provided that the argument is a logical one, help the reader absorb your message.

Copy and the rough design are the raw materials of the designer who is responsible for producing the finished artwork for the printer. The interplay between the designer who knows about graphics and typography, and the people who know about the product is a subject in itself. But the fundamentals of the relationship have already been spelled out — make sure that the designer understands who the publicity is designed for, and how it is to be used.

Good designers should be able to explain how their designs meet the needs of

the market you have specified. They should also be able to suggest minor changes to the copy that will improve the effectiveness of the finished article.

Having spent time and effort on getting the words and design right it is a tragedy to spoil the whole thing by letting mistakes through when the typesetting is done. It is very important to thoroughly check all the copy. Ignorance — real or simulated — is the best qualification for proof-reading. The human eye has a marvellous propensity for seeing what it expects to see even when this is different from what has been written.

This is accentuated when the proof-reader is also the original author, so if possible someone else should do the checking. Avoid that awful feeling of spotting a glaring error when the boxes of printed literature are delivered from the printer.

You have identified the market, and how you are going to get at it. You have produced a stunning selling document — now make sure the plans get carried through. Publicity material is expensive to produce but resist the temptation to over-order because the print costs for the extra copies are comparatively small. If you have no immediate plan for using them, they will probably never be used. If you have worked out a proper campaign with a specific rate of return, you will easily be able to afford a reprint when necessary incorporating the latest changes. It is amazing how many companies throw their hands up in horror at the cost of printing while throwing away unused publicity material which has outlived its usefulness. 

Checking the proofs.

Read all the headlines, flashes, and vital details

Concentrate on addresses, telephone numbers, prices, dates, order reference numbers.

These are crucial parts in which errors have disastrous results — even maybe the time and expense of reprinting.

Scan the text without absorbing the meaning

Look at each word as a separate entity — this should uncover most of the keying errors in typesetting.

Read the text concentrating on the meaning

This will uncover the type of error where one word has been converted to another word. "Now" converted to "Not" is an example and one which plays havoc with the meaning of the text.

Make sure the corrections are checked

Errors have a habit of slipping through at this stage because of the overwhelming desire to get the artwork to the printers as soon as possible.

Better buy Cumana strictly dependable top Quality Products like TEAC... like no one else for price!

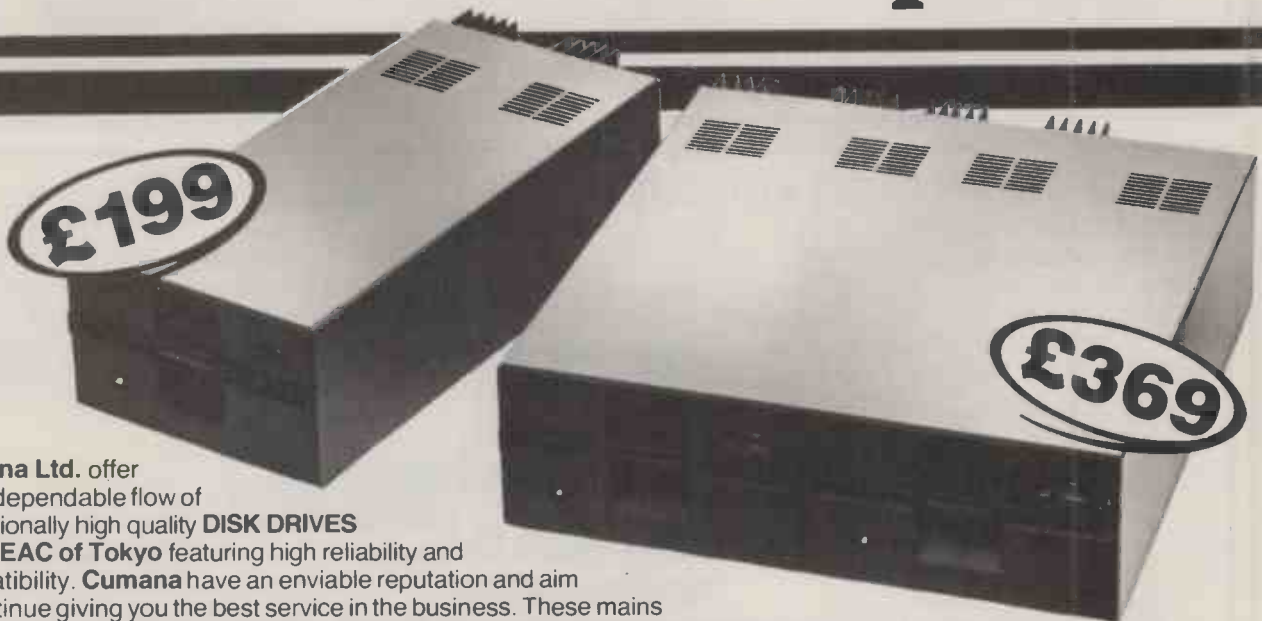

Cumana Ltd. offer you a dependable flow of exceptionally high quality **DISK DRIVES** from **TEAC of Tokyo** featuring high reliability and compatibility. Cumana have an enviable reputation and aim to continue giving you the best service in the business. These mains powered Disk Drive units are designed to interface to a wide range of computers such as **TRS 80 models I and III, Genie I and II, SWTP, Heathkit, Superbrain, Nascom** and the **BBC Micro, Model B.**

Floppy Disk Drives 40 and 80 Track Cased Units

Single Disk Units

1x40 Track single sided Drive	£199
1x80 Track single sided Drive	£265
1x80 Track double sided Drive	£429

Dual Disk Units

2x40 Track single sided Drives	£369
2x80 Track single sided Drives	£495
2x80 Track double sided Drives	£799

Disk Drive Cables

2 Drive Cable	£15.00
4 Drive Cable	£25.00

Please add VAT to all prices. Delivery at cost will be advised at time of order.

CUMANA LTD

35 Walnut Tree Close, Guildford, Surrey GU1 4UN. Telephone: (0483) 503121. Telex: 858306.

Call your nearest dealer for a demonstration: Write or 'phone for Data Sheets - Dealer and O.E.M. enquiries welcome.

RADIO SHACK LTD.,
London NW6. Tel: 01-624-7174

COMP SHOP LTD.,
New Barnet, Herts.
Tel: 01-441-2922

COMP SHOP LTD.,
London W2. Tel: 01-262-0387

COMP SHOP LTD.,
Dublin 2. Tel: 604165

LONDON COMPUTER CENTRE,
London W1. Tel: 01-388-5721

N.I.C.,
London N15. Tel: 01-808-0377

CROYDON COMPUTER CENTRE,
Thornton Heath, Surrey.
Tel: 01-689-1280

P J EQUIPMENT LTD.,
Guildford. Tel: 0483-504801

R.D.S. ELECTRICAL LTD.,
Portsmouth. Tel: 0705-812478

TANDY HASTINGS LTD.,
Hastings. Tel: 0424-431849

MICROWARE COMPUTING SERVICES,
Bristol. Tel: 0272-279560

BLANDFORD COMPUTERS,
Blandford Forum.
Tel: 0258-53737

TAPE SHOP,
Brighton. Tel: 0273-609099

PARWEST LTD.,
Chippenham. Tel: 0249-2131

HCCS ASSOCIATES,
Gateshead.
Tel: 0632 821924

COMPUTER SHACK,
Cheltenham. Tel: 0242-584343

TANDY GLOUCESTER,
Gloucester. Tel: 0452-31323

COMSERVE,
Bedford. Tel: 0234-216749

EMPRISE LTD.,
Colchester. Tel: 0206-865926

MAGNUS MICRO-COMPUTERS,
Kidlington, Oxford.
Tel: 08675-6703

CAMBRIDGE COMPUTER STORE,
Cambridge. Tel: 0223-65334

OFF RECORDS,
Computer House,
London SW11 1HH.
Tel: 01-223 7730

I.C. ELECTRONICS,
Biddenden, Kent.
Tel: 0580-291816

MICRO CHIP SHOP,
Fleetwood, Lancs.
Tel: 03917-79511

HARDEN MICRO-SYSTEMS,
Blackpool. Tel: 0253-27590

AMBASSADOR BUSINESS COMPUTERS LTD.,
Shipley, W. Yorks.
Tel: 0274-595941

Q-TEK SYSTEMS LTD.,
Stevenage, Herts.
Tel: 0438-65385

COMPUTER & CHIPS LTD.,
Feddinch Mains,
St. Andrews, Scotland.
Tel: 0334 76206

HEWART MICRO-ELECTRONICS,
Macclesfield. Tel: 0625-22030

KARADAWN LTD.,
Great Sankey, Warrington.
Tel: 0925-572668

PHOTO-ELECTRICS,
Sheffield. Tel: 0742 53865

ARC ELECTRONICS,
Nr. Wakefield, W. Yorks
WF2 6SL. Tel: 0924-253145

VICTOR MORRIS LTD.,
Glasgow, G2 8LY.
Tel: 041-221 8958

COMPRITE LTD.,
Laisterdyke, Bradford.
Tel: 0274-663471

GNOMIC LTD.,
Blackhall, Hartlepool.
Tel: 0763-863871

BRIERS COMPUTER SERVICES,
Middlesbrough, Cleveland. Tel: 0642-242017

3 LINE COMPUTING,
Hull. Tel: 0482-445496

H.C. COMPUTER SALES LTD.,
Gateshead. Tel: 0632-874811

EWL COMPUTERS LTD.,
Glasgow. Tel: 041-332-7642

EVERYMAN COMPUTING,
Westbury, Wilts.
Tel: 0373-864644

CHRISALID SYSTEMS AND SOFTWARE,
Berkhamsted, Herts.
Tel: 04427 74569

STOP HERE

APPLE SYSTEMS

WANT TO BUY AN APPLE][
£550 ?

HERE'S HOW!!!
 PURCHASE OUR HARDWARE PACKAGE

HARDWARE

- ★ 48K APPLE][
- ★ DISK W/CONTROLLER
- ★ DISK W/OUT CONTROLLER
- ★ BMC 12" GREEN SCREEN HI RES MONITOR
- ★ MX80 FT/2 HI RES PRINTER
- ★ PRINTER INTERFACE

SOFTWARE AVAILABLE

- INVOICING
- PURCHASE/SALES LEDGER
- PAYROLL
- VISICALC
- VISIDEX
- VISITREND/VISIPLOT
- WORD PROCESSING

HARDWARE PACKAGE PRICE £1699



PET SYSTEMS

Ideal for: YOUR BUSINESS • EDUCATION • WORD PROCESSING

- 8032 32K Computer 80 column £755
- 8096 96K Computer 80 column £1040
- 8050 950K Dual Drive £755
- 8023 Tractor Feed Printer £785
- NEW PRODUCTS NOW AVAILABLE*
- 8422 22 Megabyte Winchester Disk POA
- 9000 SuperPet 134K
- MULTI LANGUAGE POA

- 4016 16K Computer £445
- 4032 32K Computer £560
- 2031 171K Single Drive £349
- 4040 343K Dual Drive £560
- 4022 Tractor Feed Printer £350



Choice of software packages available, such as:

WORD PROCESSING, INTEGRATED ACCOUNTS WITH STOCK, INVOICING & FINANCIAL PLANNING, AND MANY OTHER APPLICATIONS

LONDON'S MAIN EPSON DISTRIBUTOR

PRINTERS



EPSON MX100 £480

15½" carriage, 254 columns, hi res graphics, true descenders, bi directional.

EPSON MX80 £320

Dot-matrix printer Pet and Apple compatible. True bi directional, 80 cps.

EPSON MX82 £355

As MX80 plus high resolution graphics, parallel and serial. Interfaces.

EPSON MX80 FT/1 £340

Dual single sheet friction and tractor feed, 9 wire head, true descenders.

EPSON MX80 FT/2 £380

An FT/1 with high resolution graphics.

SEIKOSHA GP100 £189

Dot matrix 5x7, 80 columns, 30 cps graphics, double width characters.

TERMS

All items carry 1 year guarantee parts and labour. Delivery at cost. All prices exclusive of VAT.

Please add 15% to total Telex 22568. Official orders welcome.

JUST PHONE FOR FURTHER DETAILS



CHROMASONIC electronics

48 JUNCTION ROAD, ARCHWAY, LONDON N19 5RD TEL 01-263 9493 263 9495 TELEX 22568

100 yards from Archway Station and 9 Bus Routes

● Circle No. 163

MIDAS S100 SYSTEMS

MIDAS 1: From £835

MIDAS 2: From £1,790

MIDAS 3: From £2,450

MIDAS 3HD: From £5,495

ITHACA-DPS 1: From £1,494

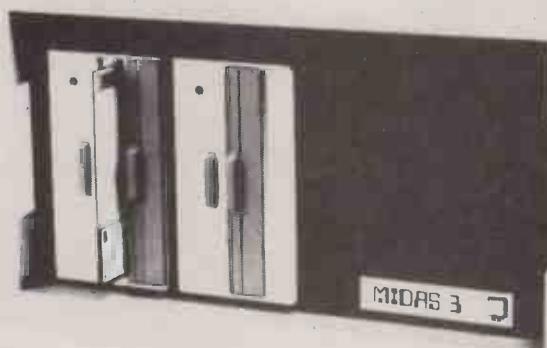

- Our versatile Z80 Microcomputers are available as standard units or custom configured to your exact specification from a comprehensive range of stocked S100 boards.
- Disc storage capacity of the MIDAS 3 can be 2M Bytes, expandable to over 80M Bytes with a Winchester Hard Disc Unit in our MIDAS 3HD range.
- MIDAS runs CP/M and MP/M. Other Software includes M-BASIC, C-BASIC, FORTRAN, COBOL, CIS-COBOL, PASCAL and Word Processing.
- A MIDAS 3D with 64K RAM and 2M Bytes storage on two 8" drives with two Serial I/O Ports and CP/M only £2985.
- Printers, VDUs and other peripherals stocked to give complete package system at keen prices.

BOARDS

We stock over 50 different S100 Boards all from quality manufacturers, such as Godbout, SSM, Micromation, Dual, Ithaca, Vector, S.D. Systems, Morrow, Pickles & Trout, etc.

PROCESSOR

Z80 Starter Kit	£251
SBC 100	£215
8085/88 CPU	£190
Z80A CPU 4MHz (4 Types)	From £183
8086	(tba)

EPROM

27 16 EPROM (2 x 16K)	£95
2768/2716/2732 Programmer	From £143

VIDEO BOARDS

24 x 80 I/O Drive	£298
24 x 80 Memory Mapped	£298

DISK CONTROLLERS

Single Density 5" or 8"	From £285
Disc 1 D/D DMA	£282
Double D/D + Serial I/O	£336

RAM

Static RAM 16-64K 24 Bit add.	From £175
Dynamic RAM 64K 8/16 Bit	£683
Memory Manager	£60

I/O BOARDS

2s/2p or 4s/2p or 3p/1s etc	From £120
A/D & D/A 8 or 12 Bit	From £220
IEE 488 interface	£360

MISCELLANEOUS

Real Time Clocks (2 Types)	From £120
Graphics 512 x 256	£416
Maths Board AMD 9511	£345
Extender Boards/Logic Probe	£45
Mother Boards 8-20 Way	From £32

MAINFRAMES

We are the sole UK Distributor for Integrand Mainframes and Disc Enclosures, available in nine models including Desk Top and Rack Mounting, with or without provision for Disc Drives. All units totally enclosed, painted on all external surfaces and complete with power supply etc.

SOFTWARE

CP/M 1 & 2, MP/M, PL/1, C-BASIC 2, M-BASIC V5, XYBASIC, FORTRAN 80, COBOL 80, CIS-COBOL, PRO-PASCAL, Forth, MAC, ZSID, Disassembler, Wordstar, Datastar, Magic Wand, Wordmaster, Supersoft etc etc.

Prices exclusive of VAT

We are pleased to discuss your requirements and will advise you as to whether your needs can be met with one of our computers.

All of our systems are specials as they are configured to suit your specification, thus ensuring that you get what you want rather than what happens to be available.

Write or phone for a catalogue.

Unit 14, 29 Willow Lane, Mitcham, Surrey

Telephone: 01-640 6931/2/3

Chris Histed presents a portable invaders game in Basic

Alien blaster

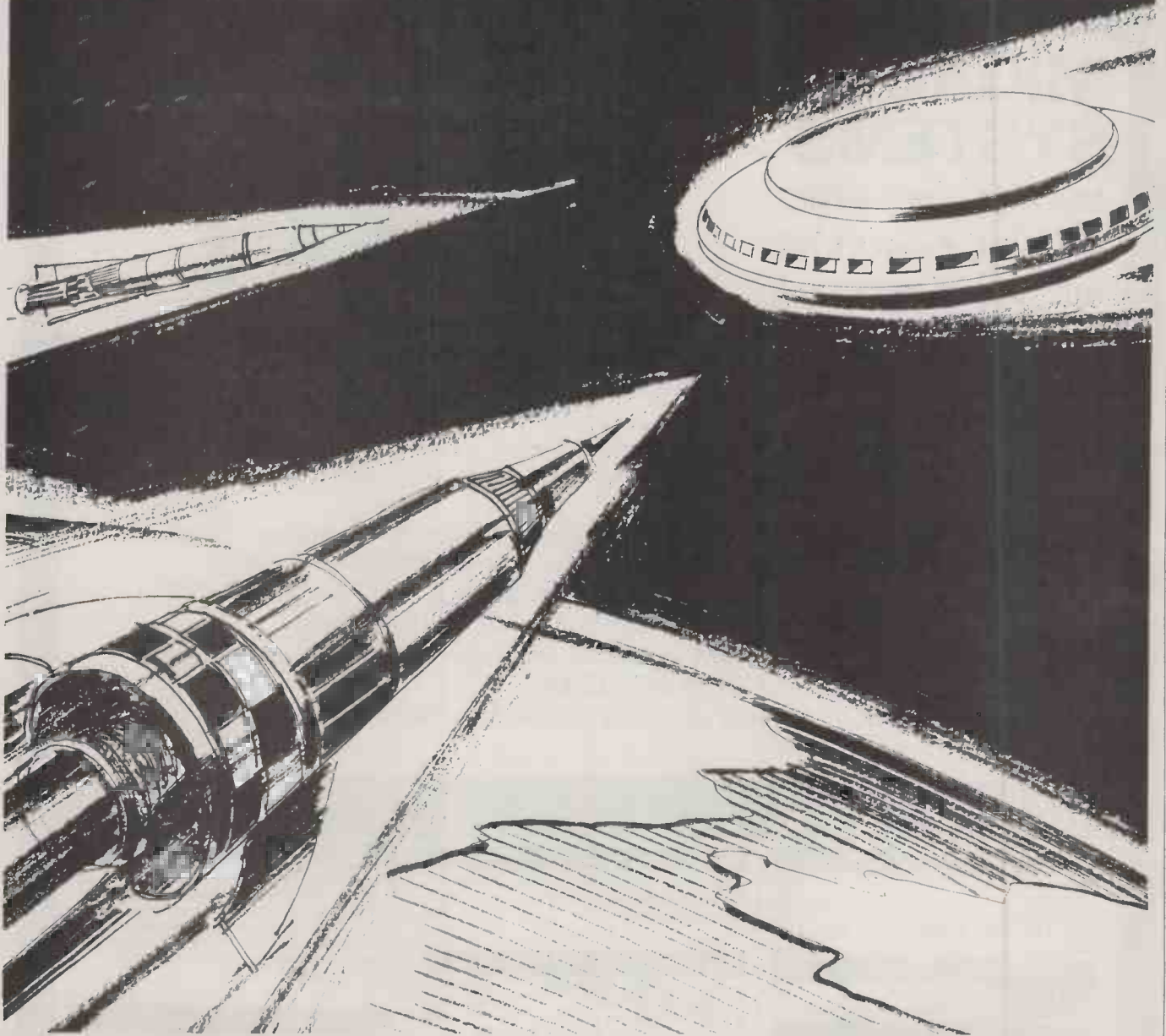

YOU ARE STRANDED at the bottom of a large lunar crater, in charge of the only remaining laser blaster ship on the moon. A fleet of alien spacecraft has decided to invade the moon, and their objective is to land at the bottom of your crater, capturing the moon and enslaving mankind.

Your blaster ship is equipped with an array of laser-blast cannon, with which you must try to destroy the alien invaders. Every time you fire off a laser missile at the invading battle fleet, your phaser energy drops from a starting value of 1,000 at the beginning of the game, in steps of between 10 and 20 to a final value of zero. At that point your expertise is

assessed, and the game comes to an end.

UFO Master Blaster is a fast, real-time space invaders program with good graphics. It is written for the North Star Horizon, and is suitable for any fast micro with some form of direct cursor addressing. It runs in about 8K of memory, using normal North Star Basic which has no specialised commands. The only shortening is the use of the exclamation mark to replace the print statement.

At any time there are a maximum of four invaders on the screen above your crater. As you shoot one out, a new alien is generated and displayed at a very fast rate. You will have your work cut out

trying to keep them from descending too far down the screen.

Also on the screen from time to time will be either a bomb or a flying saucer, which score higher points than mere invader ships. There are two types of bomb and one type of flying saucer. The "o" bomb is a nasty weapon used by the invaders as it will aim for your laser blaster, and unless you shoot it out it will home in on your blaster and destroy it.

The other sort of bomb, the "y" bomb, does not aim for you but can be equally deadly as it descends in a random manner from one of the alien battle fleet.

Occasionally a flying saucer will fly

(continued from previous page)

value of Y sends the cursor to the Yth row down and the value of X sends it to the Xth column across. This function allows you to print the invaders at any points on the screen, and its speed allows a very fast and flowing game with no pauses to draw on the screen.

Printing O\$ will put the terminal into inverse video — whatever it prints following this command will appear black on white. Printing of O1\$ will bring the terminal back to normal white on black, which is used when printing words on the screen, and in setting up the shapes of your space ship, S\$, and the aliens, A\$. When setting up the screen in lines 50 to 80 a function of the terminal which is a limited form of line graphics was used.

Printing

CHR\$(27); "1"

puts the terminal into graphics mode, and

CHR\$(27); "2"

takes it out. These commands may be omitted on your machine but in the next three lines you should change lower-case "e" to vertical lines, and I, M and lower-case "a" to horizontal lines.

Once you start playing this game, it can become quite addictive. A good score for the first game is about 2,000 points, but once you are expert at the game an average score should be over 6,500. The record to beat is 8,014.

(listing continued from previous page)

```
4809:CHR$(27),"Y",CHR$(33),CHR$(32+84)," "
4810:CHR$(27),"Y",CHR$(33),CHR$(32+82),"C",08,"EEE",018,">"\GOTO120
4815:CHR$(27),"Y",CHR$(33),CHR$(32+84)," " \GOTO120
4998REM
4999REM ***** An Alien Lands on your base *****
5000REM
5001:CHR$(27),"Y",CHR$(52),CHR$(32+H),08," " ,018
5005:CHR$(7),
5010FORX=1TO3000NEXT
5020:CHR$(12)\N:\N:\N:" You have finished the game , with a final Grand Score of "
5030:(S+4)*(P-0.5)+6*(S+10)
6000END
29999REM
30000REM ***** If it is an 'o' bomb ,aim-It for Laser base *****
30001REM
30010 IF B2>H THEN M=-1\IF B2<H THEN M=1\IFB2=H THEN M=0
30020 GB=GB+1\IF GB<69THEN 30030\GB=-1\GOTO4700
30030 B2=B2+M\B1=B1+1\GOTO4730
39999REM
40000REM ***** Instructions *****
40001REM
40010:CHR$(12)\FORX=1TO100NEXTX:\TAB(25),08," Alien Invaders ",018\
40020!" In this game , you control a Laser armed Fighter Ship which is "
40030!" stranded at the bottom of a Lunar Crater. You start with 1000 "
40040!" points of phasor energy , and each time you fire your weapons "
40050!" this decreases by between 10 and 20 points "
40060!" You control the movement of your ship by the keys 4,5, and 6"
40070!" To move left press 4 ,right 6, and to remain in position press 5"
40080!" To fire your phasor gun , press 0 "
40090!" You will see a number of aliens drop from the sky towards you , "
40100!" and it is your task to destroy these ,by positioning your ship "
40110!" under them , and firing your Weapon ..... "
40120!" The aliens will drop two types of Bombs , an 'o' sort , which will"
40130!" aim for you , and probably hit ,unless you destroy it ; and a 'Y'"
40140!" sort , which do not aim for you ;and a flying saucer worth 100 "
40145!" points may fly overhead ,every so often"
40150!" You get points for shooting down Aliens , and more for shooting "
40160!" down Bombs ('o' bombs score highest )"
40170!" The game will end when your energy goes below zero , or a bomb hits"
40180!" you , or the Aliens get down to the Bottom of the Crater "
40190!" This game was written 5th Feb. 1981 by Christopher Histed !!! "
40200!" Press any key to start "
40210N=INP(2)
40220IFN =INP(2)THEN40220
40230 GOTO 32
```



L&J COMPUTERS

192 HONEYPOT LANE, QUEENSBURY, STANMORE, MIDDX HA7 1EE. 01-204 7525

THE "PET" SPECIALISTS



GET THE BEST OF BOTH WORLDS!
WE CAN SUPPLY ALL YOUR 'PET' NEEDS AT CASH & CARRY PRICES

OR WE CAN SUPPLY INSTALL AND TRAIN YOUR STAFF AT THE NORMAL PRICE WITHOUT ANY EXTRAS!!

TRY US!
YOU WILL NOT BE DISAPPOINTED

4016	16K Computer	£550	£460
4032	32K Computer	£695	£575
2031	171K Single Drive Floppy Disk	£395	£350
4040	343K Dual Drive Floppy Disc	£695	£575
4022	Tractor Feed Printer	£395	£350
8032	32K Computer	£895	£750
8096	96K Computer	£1195	£995
8050	950K Dual Drive Floppy Disk	£895	£750
8023	Tractor Feed Printer	£895	£750
8422	22 Megabyte Winchester Disk	£3495	£3250
9000	SuperPet 134K Multilanguage Computer	£1495	£3250

TOOL KITS (BASIC 2 & 4), SUPERCHIPS AND ALL SORTS OF OTHER CHIPS

COME AND SEE THE NEW VIC-20
£165.00
FULLY WORKING AND OPERATIONAL

ASK US ABOUT ALL THE ADD-ON-GOODIES THAT GO WITH THE VIC . . . !

MASSES OF BOOKS ON THE PET & VIC

SILICON OFFICE : WORDCRAFT : WORDPRO
D.M.S.V. : ADMINISTRATOR : DATALEX BASIC &
SUPERPAY : ACCOUNTS : VISICALC

For those with 3032's who want 4032's and those with 4032's who sigh for 3032's, all is not lost! HAVE BOTH, at the flick of a switch — CHIPSWITCH for £57+ ROMs for £50 (with de-glitching facility built-in).

Send us a large stamped addressed envelope (12 x 9) and we will be delighted to send you all our current information!
PRICES DO NOT INCLUDE VAT

PERSONAL SHOPPERS WELCOME
Phone & Mail Orders accepted

ALL GOODS SENT SAME DAY WHEREVER POSSIBLE
LARGE S.A.E. FOR LISTS ETC.

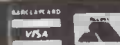

You can't get a Home Computer from Texas Instruments under 16 K RAM.



Make the right move into computing with the Home Computer from Texas Instruments. It gives you a large combined RAM/ROM capacity up to 110 K Byte and the ability to expand with a full range of peripherals and software. So as your knowledge of computers increases the TI Home Computer will grow with you.

Just compare the versatility of the TI Home Computer with its price - you'll find it real value for money that will prove to be a good long term investment.

The TI-99/4A is a sophisticated computer designed not only for the beginner with its ease of operation, but also for the professional with its vast computing power through a 16 bit microprocessor. And it simply plugs into an ordinary household TV set.



With its high resolution graphics with 32 characters over 24 lines in 16 colours (256 x 192 dots), 3 tones in five octaves plus noise, and BASIC as standard equipment and options such as other programming languages - UCSD-PASCAL, TI-LOGO and ASSEMBLER - and speech synthesis, you'll find that the TI 99/4A more than compares with the competition. Especially when the starting price is around £200. When you want to solve problems there are over 600 software programs available worldwide - including more than 40 on easy-to-use Solid State Software® Modules.

After all, from the inventors of the microprocessor, integrated circuit and microcomputer, it's only natural to expect high technology at a realistic price.



We'll help you do better.

TEXAS INSTRUMENTS
LIMITED

● Circle No. 166

119

**UNBEATABLE VALUE
AT AROUND £200**

Fill-in-the-blanks used in structured programming

Using a few standard sentences, Program Description Language can be applied to any program and translated into the relevant language. Graham Beech continues his discussion on structured programming with a look at PDL.

PROGRAM DESCRIPTION LANGUAGE PDL is a simple language used in the design of structured programs as an alternative to flowcharts. Program design using PDL proceeds in three stages:

- Design the solution to a problem as a series of connected blocks.
- Design the content of the blocks with PDL.
- Translate the PDL sequences into a programming language such as Basic.

PDL consists of a few standard sentences or "constructs" which are used as if they were fill-in-the-blanks templates. In other words, you start with one of the standard sentences and insert the context appropriate to your particular program.

PDL is not completely standardised but, for present purposes, there are just five constructs to learn. The three original ones were:

- simple sequence,
- alternative clause,
- repetition.

Two others are added for convenience:

- iteration,
- case statement.

The PDL constructs can be translated almost automatically into the programming language of your choice. A design is written in PDL. By obeying a set of rules defined for your chosen language, known as the target language, you produce the target program. This process is illustrated in figure 1.

In the example used here, the target language is Basic. The final Basic program will, of course, not look like PDL, but will contain a mixture of Basic statements, including Gotos. The main advantages are that the Basic coding will be written more quickly and it will stand more chance of working first time.

The simple sequence is a series of simple statements that are to be executed

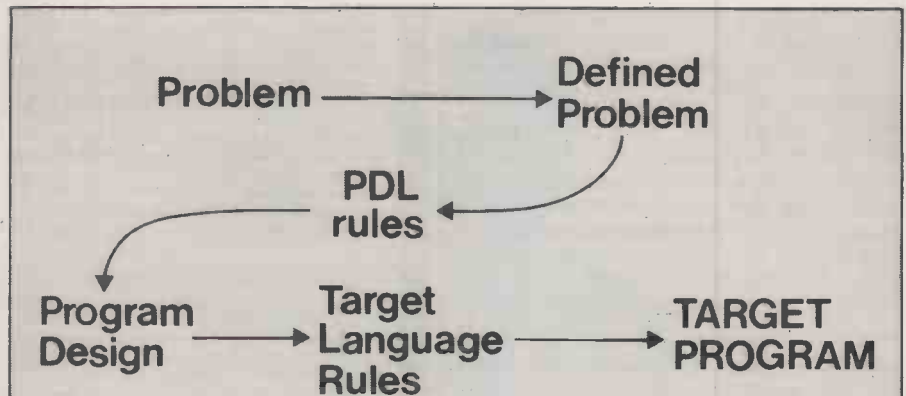

Figure 1.

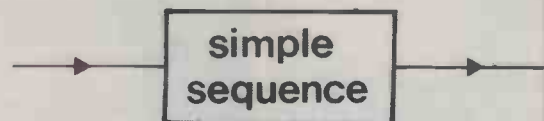

Figure 2.

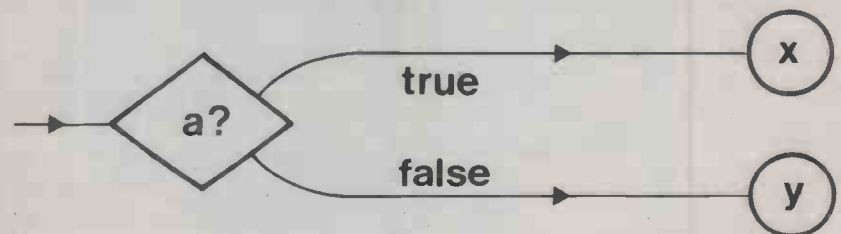

Figure 3.

in their order of presentation. For example,

1. Get out of bed
 2. Get dressed
 3. Have breakfast
- and so on. One statement simply follows another.

The alternative clause has the form:
if a is true then perform x else perform y

It can be depicted in terms of a flow chart — see figure 3. There may not be an else sub-clause, in which case it is simply omitted.

To indicate the range of the if clause an indicator is used — as end is used as a terminator to begin. The convention end if allows the whole construct to be briefly stated as:

if a is true then perform x else perform y end if

where x and y are constructs which may, for example, be simple sequences. Notice that the PDL words such as if, then are underlined. An example is:

if age less than 5 then travel free else fare = miles × 10 end if

Some people use `fi` instead of `end if`, but this seems a little inelegant.

The Choice clause can be regarded as a convenient extension of the alternative clause. It permits the selection of one action from several in a similar fashion to multiple-choice test questions:

```

case of
  case 1: action 1
  case 2: action 2
  case n: action n
end case
    
```

This avoids the multiple usage of the alternative clause and is clearly equivalent to the flow chart structure shown in figure 4. Only one of the n possible cases will be executed. For example, an electricity tariff could be arranged:

```

case of
  no consumption: fixed charge only
  up to 100 units: fixed charge + units  $\times$  3
  over 100 units: fixed charge + 300 + (units - 100)  $\times$  2
end case
    
```

The notation `esac` is sometimes used instead of `end case`.

The repetition clause repeats some action `until` some condition is true; therefore, the action will be executed at least once:

```

do action b until a is true end do
    
```

where `b` is a construct. The flow chart for this is shown in figure 5. For example,

```

do
  type a line on page
  until the page is full
end do
    
```

Iteration is similar to repetition, having the form:

```

while a is true do action b end do
    
```

The difference is that the logical test is performed `before` performing the actions in `b`. Consequently, `b` will not be encountered if condition `a` is initially false. For example,

```

while the page is not full
  do type a line end do
    
```

Iteration or repetition are familiar concepts since one of them is directly available in most programming languages as a loop statement. The construct `for index initial by step until final do (b) end do` in which `index` is increased from "initial" to "final" in increments of "step" is recognisable as a special case of the more general `while` construct. It is represented by the flow chart in figure 7.

Notice the use of the back arrow \leftarrow as an assignment operator. The sequence `b` will never be executed if "index" is greater than "final", even at the beginning of the step. Omission of the "by step" implies a step size of 1.

For example:

```

for
  contents of tank  $\leftarrow$  one gallon by half-gallon
  until full do add fuel end do;
  but if the "by step" is omitted, a step size 1 is implied:
  for count  $\leftarrow$  1 until total do sum  $\leftarrow$  sum + 1
  end do
    
```

The final value of `sum`, assuming it to be zero initially, would be equal to `sum + total`. □

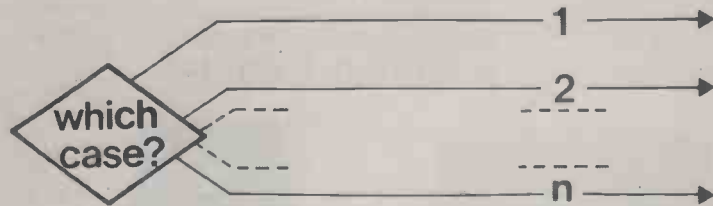

Figure 4.

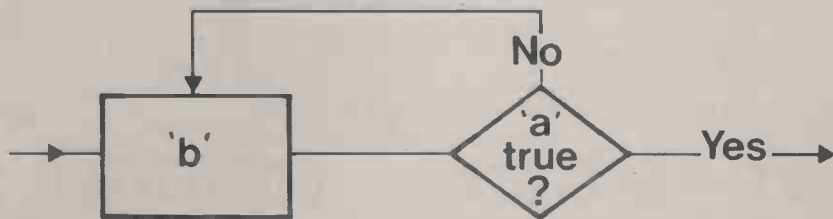

Figure 5.

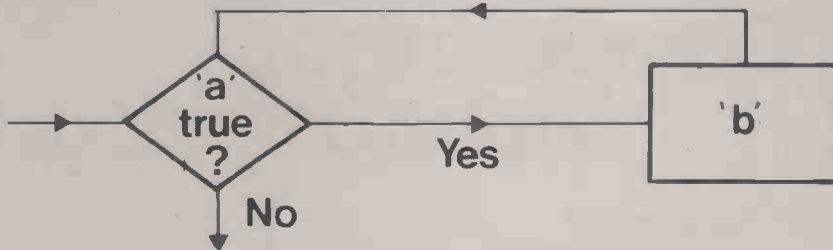

Figure 6.

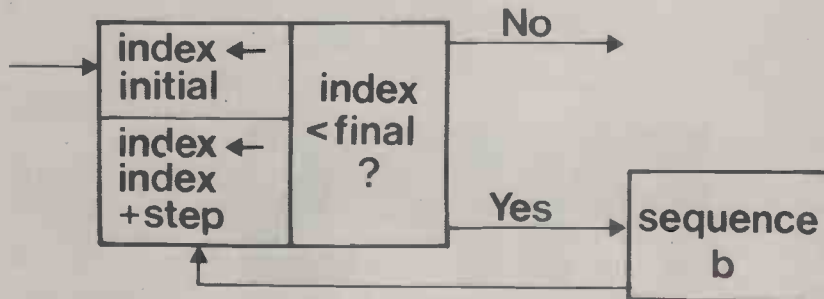

Figure 7.

WHY BUY FROM CAMDEN?

- ★ WE SUPPLY : THE **HARDWARE**
- ★ WE SUPPLY : THE **SOFTWARE**
- ★ WE SUPPLY : THE **BACK-UP**
- ★ WE SUPPLY : THE **EXPERIENCE**
- ★ WE SUPPLY : THE **KNOWLEDGE**

MAIN DISTRIBUTORS FOR ALL THE LEADING MAKES OF MICROCOMPUTERS AND PERIPHERALS. OFF THE SHELF PROGRAMS TO SUIT MOST APPLICATIONS FROM THE LEADING SOFTWARE HOUSES — WITH PROVEN RELIABILITY. FROM OUR OWN ENGINEERING WORKSHOPS WITH FULLY QUALIFIED TECHNICIANS OR ON-SITE SERVICE — YOUR CHOICE. AS ONE OF THE COUNTRY'S LEADING DISTRIBUTORS WITH PROVEN SALES RECORDS — AND ONE OF THE PIONEERS OF THE MICROCHIP. OUR FULLY TRAINED STAFF WILL ADVISE ON YOUR REQUIREMENTS TO SUIT YOUR NEEDS AND IMPROVE YOUR BUSINESS.



Superbrain

64K QD MODEL
PLUS EPSON MX80FT
PLUS FULLY INTEGRATED
ACCOUNTS PACKAGE
£18 PER WEEK LEASE
OR PURCHASE



commodore

8032 80 COL MODEL
8050 1 MEG DUAL DISK
RP1600 DAISYWHEEL PRINTER
WORDCRAFT 80 WORD PRO
£18 PER WEEK LEASE
OR PURCHASE



apple computer

128K MODEL
INCLUDES MONITOR
VISICALC III — SOS
MAIL LIST MANAGER
AND APPLE BUSINESS BASIC
PLUS SILENTYPE PRINTER
PLUS ADDITIONAL DISK DRIVE
£18 PER WEEK LEASE
OR PURCHASE



CAMDEN
THE COMPUTER
PEOPLE



COMPUTER SYSTEMS LTD

462 COVENTRY ROAD, SMALL HEATH, BIRMINGHAM B10 0UG
PHONE: 021-771 3636 (10 lines) TELEX: 335909 (CAMDEN G)

NORTHERN BRANCH OFFICE: 95 MEADOW LANE, LEEDS LS11 5DW
TELEPHONE: 0532 446946 TELEX: 335909



● Circle No. 168

Computing.... without programming?



PIPS
more basic
than 'Basic'

The problem is how to computerise the present job, and to do it fast, but programming still presents an enormous obstacle.

PIPS is one giant step towards solving this problem, as it makes it possible to use personal computers without programming.

PIPS gives you access to the power of the computer without having to learn BASIC, or any other computer language.

Moreover, programming in BASIC is a costly and lengthy task — with PIPS it's only a matter of pressing a few keys.

PIPS Easy for beginners . . . Powerful for experts.

PIPS is available on the 'EXPERT' and 'EXECUTIVE' range of microcomputers.



For further details and address of your local dealer, write or telephone

EXLEIGH BUSINESS MACHINES

11 Market Place, Penzance, Cornwall TR18 2JB

Telephone: (0736) 66577/8

● Circle No. 167



APPLE II (48K) · APPLE III (128K)
 SYSTEM A: £939 SYSTEM B: £3152
 SYSTEM B: £1843 SYSTEM C: £3900
 SYSTEM C: £2580 SYSTEM D: £5335

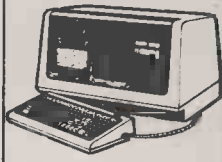

TELEVIDEO 800 Series
 SYSTEM B: £2817 SYSTEM E: £8176
 SYSTEM C: £3313 (Three Users) SYSTEM E: £11995
 SYSTEM D: £4832 (Six Users—10MB) SYSTEM E: £26662
 (Sixteen Users—23MB)



ALTOS (192K) Series 5
 SYSTEM B: £3309 SYSTEM D: £5549
 SYSTEM C: £3755 SYSTEM E: £6174
 (Two Users)
 SYSTEM E: £6799
 (Three Users)



ICL (64K to 256K)
 SYSTEM B: £3355 SYSTEM E: £7210
 SYSTEM C: £4645 (Three Users) SYSTEM E: £7710
 SYSTEM D: £4710 (Four Users) SYSTEM E: £8210
 SYSTEM E: £5755 (Five Users)

NEW RAIR 3/50 (256K RAM)
 — with 16 Mbyte Hard Disk & 630K floppy

SYSTEM E: £8164 (Two Users) SYSTEM E: £9094 (Four Users)
 SYSTEM E: £8629 (Three Users) SYSTEM E: £9559 (Five Users)
 (Expandable to 16 Users, Rental available)

BUY OR LEASE

A wide selection
 of Computers
 plus a service facility
 that's second to
 none.

SYSTEM A: Basic Computer including display screen and keyboard
 SYSTEM B: Computer including display screen, keyboard, dual disk drive(s) and matrix printer for Business Users (e.g. Accounts, Database, etc)
 SYSTEM C: Computer including display, keyboard, dual disk drive(s) and daisy-wheel correspondence quality printer for Word Processing.
 SYSTEM D: Computer including display, keyboard, floppy disk drive, plus hard disk drive for 5 Mbyte+ on-line and matrix printer. (SOME Systems expandable to 120 Mb).
 SYSTEM E: Multi-User Computer — AS SYSTEM D — plus Additional VDU Terminals for up to 5 Users.
 Prices exclude VAT.

Johnson
 microcomputers



Johnson House · 75-79 Park Street · Camberley · Surrey · Telephone 0276 20446
 Robophone Answering 24 hrs. Prestel page No. * 200632 Mailbox No. 027620448
 48 Gloucester Road · Bristol · Telephone 0272 422061
 148 Cowley Road · Oxford · Telephone 0865 721461

● Circle No. 171

Most software is really hard

Why is it that most software is harder to handle than you are led to believe?
 Is it because it's American, and gets tied in knots by British Red Tape, such as V.A.T., while the only chap who can untangle it is in the States?
 Is it because it doesn't want to work with your hardware?
 Is it because it doesn't understand English, so you have to learn and continually translate into some form of "computer speak"?
 Is it because your different software modules don't integrate as easily as claimed, because not only do they speak a different language from you, but from each other as well?

Is it because it's so hard and slow to move from one field of information to another?
 Is it because you talked to the wrong people in the first place?
 We design and produce software systems for British business people, systems that understand plain English, that really do integrate because they have one common language which also happens to be yours, and systems that you can work with really fast and effectively. The only hard thing about our software is the thought we put into it - that is what we mean when we call it "hard headed". **We do, however, also sell the very best hardware, and have designed our software to match**

so that you can buy from us a complete computer package that will work as well in your office as on paper. Our software is flexible enough, however, to work with most computers running CP/M.
Choosing the right system is not easy. It's hard to find people who'll respond to a straight question and give you a straight answer. You'll probably have the same problem with their products. If, however, you would find it a refreshing change to hear someone talk some common sense about how computers can work for your business give us a ring. We should be able to come to an understanding, which will be good for both of us.

Hard headed software from  **Derwent Data Systems**
 18 Norfolk Street, Sunderland, Tyne & Wear, SR1 1EA, England. Tel. (0783) 652026

● Circle No. 170

Adler Alphatronic Microprograms - Superbly Simple Software.

When you see the Alphatronic you will agree that it is a superb machine. However, it's the software that ensures it will do what you want done. The large software library is designed to work perfectly with the Alphatronic and is backed by the company with an unrivalled reputation in office equipment and business systems.

Adler dedicate a lot of time and effort to providing what is probably the widest range of programs for any microcomputer.

We've listed a few below:

Word Processing	Financial Forecasting
Ledgers	Telecommunications
Invoicing	Data Retrieval
Payroll	Statistical Analysis
Cash Flow	Stock Control

Plus the fine range of CP/M packages that extend the Alphatronic's performance to virtually any business problem.

So if you want a system to provide a better answer to a specific problem or even reorganise your office, you'll find we've thought it through to the solution.

The Alphatronic Business Computer starts at £1895.

Clip the coupon and find out why so many businesses trust Adler.

Price exclusive of VAT.

TA TRIUMPH ADLER

Triumph Adler (U.K.) Ltd.,
27 Goswell Road, London EC1M 7AJ.
Telephone: 01-250 1717.



Please give me more information on the Adler Alphatronic Microcomputer and library of program packages.

Name

Company

Address

Telephone

DP2

ANOTHER TRIUMPH FROM ADLER

● Circle No. 172

In these pages Brian Reffin Smith keeps you up to date with computer-based art and design and lays the foundations for graphics routines to use on your own micro.

Graphic-design bible

FOLEY AND VAN DAM: the names sound as though they belong to a pop group or a film title but, in fact, are responsible for the best book on computer graphics ever produced. *Fundamentals of Interactive Computer Graphics* is published by Addison Wesley as part of its Systems Programming series. It costs £15.95 in hardback, and has 664 pages, with many illustrations, 50 or so in colour.

You remember the Horizon programme on BBC TV around Christmas? The book reminds me visually of that, not least because it has some of the same pictures, but it goes beyond the TV programme in power and detail.

Much of the book is advanced, some is quite difficult, and a little is right at the cutting edge of what is becoming possible with the most complex graphics systems. But it is a book whose usefulness would grow with your knowledge of the area. Every art student should have access to a computer — and this book. Everyone who pretends to an interest in computer

graphics for any reason at all, should understand sufficient of the contents to make them think, and do it better.

The book asks questions such as "What is interactive graphics?", answers them and then goes on to cover hardware and software, all the usual geometric transformations, three-dimensional modelling, graphic conversations, shading, colour and visual realism. Of the 17 chapters, 16 end with exercises, many of which could be done without resort to the most expensive graphics systems.

BBC noises

MICHAEL BATES writes from London N21: "After reading your article on the BBC sound system I thought you might like a routine I have found which makes strange sounds. The key is

* KEY1 "SOUND 2, - 15,100,1; SOUND 3,103,100,1; M"

Try pressing Key 1 a few times, and after about the sixth a strange sound effect occurs. It can be changed by the tone of

the Sound 2 command, and once a sound occurs it may be recreated by just using the Sound 3 command. I think that this has something to do with the envelope commands, but I would like to have your views on this".

Well, I tried it, and I suggest you do too. Remember that the weird sign before the M means "control", and puts Ctrl-M, Return, on to the key along with the sounds. The routine appears not to need the first part — Sound 2, etc — but perhaps it did actually set something up, as suggested. I cannot see why it does what it does, which is to alternate an ordinary tone with the best imitation of running water I have yet heard from a synthesiser, let alone a computer.

* *

The three-dimensional modelling system described in July's Arts pages is the work of John Frazer of Ulster Polytechnic. Apologies to John Frazer and his colleagues for not mentioning this in the article.

BEGINNING GRAPHICS

Relatively speaking

IN THE EARLY seventies, from a room above a head-shop — if you want to know what a head-shop is, ask any aging hippy — off London's Portobello Road there was published a fine book called *An Index of Possibilities*. I contributed one or two things to it, and as I look down the list of credits at the back, which include the local supermarket, for orange juice, I see that one Peter Laurie was also involved, only later rising to the dizzy heights of editor of this magazine.

This is not mere reminiscence. Relativity is well treated in the book, and I was struck by the idea of representing a single line on the computer screen, able to

Figure 1.

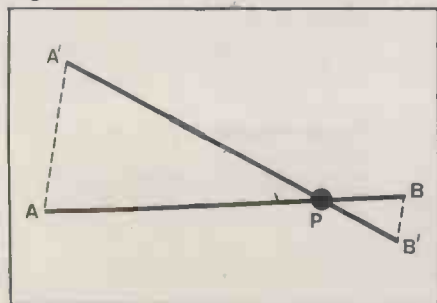

rotate about a point along its length, near one end. It should be clear that if you move the short end from B to B' the long end will move from A to A', like one half of a pair of scissors. Because the line pivots about the point P, a small movement at one end taking, say, 1 second gives a larger movement at the other end, also occurring in 1 second. So A moves faster than B, as long as P lies closer to B than to A.

Imagine that you move the point B very fast, and that the distance AP is a million times as great as PB. Then, it might occur that the speed of the end A approaches the speed of light. Now, as something approaches light's speed, time slows down, mass increases, while length decreases — this is what relativity is all about. So what happens to the point A and, more difficult to work out, to the line as a whole?

Equations approximating to the alterations in mass, length and time are given in figure 2. Of course gravity comes into it as well, especially as the mass of the line, if it were a solid rod, would become almost infinitely large as it approaches light speed.

$$\text{Length: } L' = L \sqrt{1 - \frac{v^2}{c^2}}$$

$$\text{Mass: } M' = \frac{M}{\sqrt{1 - \frac{v^2}{c^2}}}$$

$$\text{Time: } t' = t \sqrt{1 - \frac{v^2}{c^2}}$$

v = speed of body
c = speed of light

Figure 2.

Plot your line on the screen, using the two end positions. Move A to A' and B to B' in a number of steps. At each move, calculate the new length of the line — hence a new A' — its mass, and so on. Plug these into the next step. Assume that the speed is constant and that the effects occur down the line, gradually being diminished as you reach the pivot, which does not itself move.

Does the line curve? Does it ever reach a final position? Can you show what happens graphically, and provide a read-out of parameters and values at the bottom of the screen?

The case for consulting professionals



Birmingham
The Byteshop,
94-96 Hurst Street. Tel: 021-622 7149.

Glasgow
The Byteshop, Magnet House
61 Waterloo Street. Tel: 041-221 7409.

London
The Byteshop,
324 Euston Road NW1.
Tel: 01-387 0505.

Manchester
The Byteshop,
11 Gateway House, Piccadilly
Station Approach. Tel: 061-236 4737

Nottingham
The Byteshop,
92A Upper Parliament Street
Tel: 0602 40576.

Southampton
Xitan Systems
23 Cumberland Place
Tel: 0703 38740.

Members of the  Comart group of companies

● Circle No. 173

Hello — help for stock control!

THE HELLO PROGRAM.....

```

10 ONERR GOTO 150
20 D$ = ""
30 HOME : INPUT "DEMO PRINTOUT?";A
   $: IF A$ < > "Y" THEN CH$ = "
   NO"
40 REM HELLO PROGRAM
50 PRINT D$;"BLOAD STOCK LOGO,A$#40
   00"
50 POKE - 16299,0: POKE - 16302,
   0: POKE - 16297,0: POKE - 16
   304,0
70 IF CH$ = "NO" THEN GET CH$: IF
   CH$ < > = " THEN CH$ = "NO": GOTO
   70
80 IF CH$ = "NO" THEN GOTO 97
90 PRINT D$;"PR#1"
100 PRINT
110 POKE - 12524,0: POKE - 12527
   ,20: POKE - 12529,255
115 POKE - 12525,64
120 PRINT CHR$(17)
130 PRINT D$;"PR#0"
140 POKE - 12527,10
150 PRINT : PRINT D$;"RUNAPPLE STO
   CK"

```

APPLE STOCK is a complete stock-control program for small businesses. It enables itemisation of the entire stock on discs in various groups or classes together with cost and stock volume. Up to 450 items may be stored on each disc, and as many discs as necessary may be used.

Once the initial inventory is completed any item may be recalled with a few keystrokes, the total value of stock or of groups or classes may be checked against cost and sale prices, and items which need restocking may be listed. To facilitate rapid and easy retrieval the program is designed to hold the entire inventory in memory. Though this limits the volume to about 450 items per disc, it provides almost instant access to any product in the total inventory.

Apple quirk

In keeping with the spirit of business software, considerable effort has been made to ensure that the program is easy to use, and to make the operating environment "friendly". To this end two commands peculiar to the Apple are used. The first, Poke 214, 128 causes the program to be run whenever a valid Applesoft command is typed. In some instances the command may be ignored in

THE MAIN PROGRAM.....

```

LENGTH IS 11138 (#2882) BYTES
10 PASS$ = "ABRACADABRA"
20 POKE 214,128
30 ONERR GOTO 210
40 PRINT
50 D$ = CHR$(4)
60 PRINT D$;"OPEN STOCK FILE,L60":
   PRINT D$;"READ STOCK FILE,R0":
   INPUT A$,B$: IF VAL (B$) =
   0 THEN GOTO 110
70 B = VAL (B$) + 1: DIM G$(B),PK
   (B),DE$(B),CP$(B),SP$(B),IS$(B),H
   L$(B),OOS$(B):B = B - 1
80 FOR I = 1 TO B: PRINT D$;"READ
   STOCK FILE,R": INPUT GK(I),P
   NK(I),DE$(I),CP(I),SP(I),IS$(I)
   ,HL(I),OOS(I)
90 NEXT I:MAX = B
100 PRINT D$;"CLOSE"
110 B = 0: FOR I = 1 TO MAX: IF GK
   (I) > = B THEN B = GK(I)
120 NEXT
130 DIM GC(B),GS(B)
140 GP = B

```

Robin Kanagasabay's Apple Stock keeps a check on your inventory, holds the total value of stock, lists items which need restocking, and prints out a customised logo.

which case Run or PR#6 should be typed to continue.

The second, Onerr Goto x, where x is a valid line number not another Onerr command, causes a branch to line x whenever an error is encountered. This may be due to an error in entering the program, a Dos error, or more importantly a Ctrl-C. The code for the error is stored in location 222 decimal, and the error corresponding to this code is listed in the Dos 3.3 manual or the Applesoft manual.

Program segments

This is used in the program both to trap any I/O errors, and to provide a quick and convenient way of returning to the menu, by typing Ctrl-C. It would, of course, be possible to protect the Reset key by putting the address of a machine-code routine in the decimal address 1010 and 1011 and calling -1169 to set up the power byte. The Apple would then perform an unconditional jump to this address when the Reset key was pressed.

The program is in three parts. Part 1 is the Hello program which loads the second part, a customised logo, and asks whether you want a printout of this logo. This section is written for the Silentype printer though it could, no doubt, be modified to work on other graphics printers. It then runs the third part, the main Apple Stock program, while leaving the Apple displaying high-resolution page 1. If you do not want to use the logo facility you can dispense with the Hello program. Simply delete line 160 from the main program, and it may be run directly.

Garbage clearance

A hello program is used, instead of simply loading the logo from the main program, because of the sheer length of Apple Stock, about 11.2K, which means it over writes high-resolution Page 1. As the Apple Stock program is loaded, the high-resolution page will fill up with junk. If you object to this insert the following in line 145 in the Hello program:

```

145 TEXT:HOME:VTAB(10):?TAB(14)
Apple Stock":?:?TAB(14)"BY":?:?TAB(14)
"ROBIN
KANAGASABAY":?:?TAB(14)"(C)1981"

```

(continued on page 129)

```

150 GOSUB 2950
160 GET A$: IF A$ < > " " THEN GOTO
   160
170 TEXT : HOME : PRINT "ENTER PAS
   SHORD " : LEN (PASS$) : " LETTERS
   " : FOR I = 1 TO LEN (PASS$) : GET
   A$
180 IF A$ < > MID$(PASS$,I,1) THEN
   GOTO 170
190 NEXT
200 X = FRE (0)
210 PRINT D$;"CLOSE": TEXT: HOME:
   PRINT TAB(10)"MENU"
220 PRINT "*****"
230 PRINT "1.....BUY OR SELL STO
   CK": PRINT
240 PRINT "2.....CREATE OR ALTER
   PRODUCTS": PRINT
250 PRINT "3.....REPORT ON STOCK
   AND PRICES": PRINT
260 PRINT "4.....REPORT ON GROUP
   VALUES": PRINT
270 PRINT "5.....REPORT ON STOCK
   BELOW MINIMUM": PRINT
280 PRINT "6.....SET NO. OF INVO
   ICE COPIES": PRINT
290 PRINT "7.....HELP": PRINT
300 PRINT "8.....EXIT OR RESET S
   VSTEP"
310 UTAB (24) : PRINT "WHICH ONE " :
320 POKE - 16303,0
330 GET A$
340 IF ASC (A$) = 13 OR ASC (A$)
   = 3 THEN GOTO 330
350 PRINT A$ :
360 GET B$ : IF ASC (B$) < > 13 THEN
   A$ = B$ : UTAB (24) : HTAB (11) :
   GOTO 350
370 CHOICE = VAL (A$) : IF CHOICE <
   1 OR CHOICE > 9 THEN UTAB (24)
   : HTAB (11) : GOTO 330
380 ON CHOICE GOTO 400,1060,1940,2
   330,2520,2810,2860,2900
390 A$ = "0" : GOTO 370
400 TEXT : HOME :
410 ONERR : GOTO 210
420 PRINT TAB(11)"BUY OR SELL ST
   CK": PRINT "*****"
430 POKE 34,2
440 PRINT : PRINT "A)SEARCH BY NAM
   E": PRINT
450 PRINT "B)SEARCH BY PRODUCT NUM
   BER": PRINT
460 PRINT "C)SEARCH BY RECORD NUMB
   ER": PRINT
470 PRINT "WHICH OPTION DO YOU WAN
   T? " :
480 GET A$: IF A$ < > "A" AND A$ <
   > "B" AND A$ < > "C" AND A$ <
   > CHR$(3) THEN GOTO 480
490 IF A$ = CHR$(3) THEN GOTO 2
   10
500 IF A$ = "A" THEN GOTO 530
510 IF A$ = "B" THEN GOTO 590
520 IF A$ = "C" THEN GOTO 630
530 HOME : PRINT : INPUT "ENTER TH
   E DESCRIPTION OF THE PRODUCT V
   OUCHSH TO FIND FULL DESCRIPTIO
   N PLEASE) " : DE$ : PRINT
540 IF LEFT$(DE$,1) = " " THEN D
   E$ = RIGHT$(DE$, (LEN (DE$) -
   1)) : GOTO 540
550 IF RIGHT$(DE$,1) = " " THEN
   DE$ = LEFT$(DE$, (LEN (DE$) -
   1)) : GOTO 550
560 FOR I = 1 TO MAX: IF DE$(I) <
   > DE$ THEN NEXT : GOTO 580
570 GOTO 660
580 GOTO 1010
590 HOME : PRINT : INPUT "ENTER PR
   ODUCT NUMBER " : A : IF A < 1 THEN
   GOTO 1010
600 FOR I = 1 TO MAX: IF (PK(I) <
   > A) THEN NEXT : GOTO 620
610 GOTO 660
620 GOTO 1010
630 HOME : PRINT : INPUT "ENTER RE
   CORD NUMBER " : A
640 IF A < 1 OR A > MAX THEN GOTO
   1010
650 I = A : GOTO 660
660 REM
670 PRINT : HOME
680 GN = GK(I):PN = PK(I):DE$ = DE$
   (I):CP = CP(I):SP = SP(I):IS$ =
   IS$(I):HL$ = HL$(I):OOS$ = OOS$
   (I)
690 TEXT : POKE 34,2: HOME
700 PRINT "GROUP NO....." : GN
710 PRINT "PRODUCT NO....." : PN
720 PRINT "DESCRIPTION....." : DE$
730 UTAB (6)
740 PRINT "COST PRICE....." : CP
750 PRINT "SELLING PRICE....." : SP
760 PRINT "IN STOCK....." : IS$
770 PRINT "MINIMUM LEVEL....." : HL$
780 PRINT "ON ORDER....." : OOS$
790 POKE 34,13

```

(listing continued on page 129)

MAXIMUM VALUE... MINIMAL COST

The popular Houston Instrument HI-PLOT range of digital plotters:

- Well designed and ruggedly constructed
- Wide choice of models
- Single or multi pen
- Easy to interface via RS232C, IEEE or Centronics compatible parallel interfaces
- Easy to use — free software listings available
- Highly reliable — good quality output
- 0.1mm step size

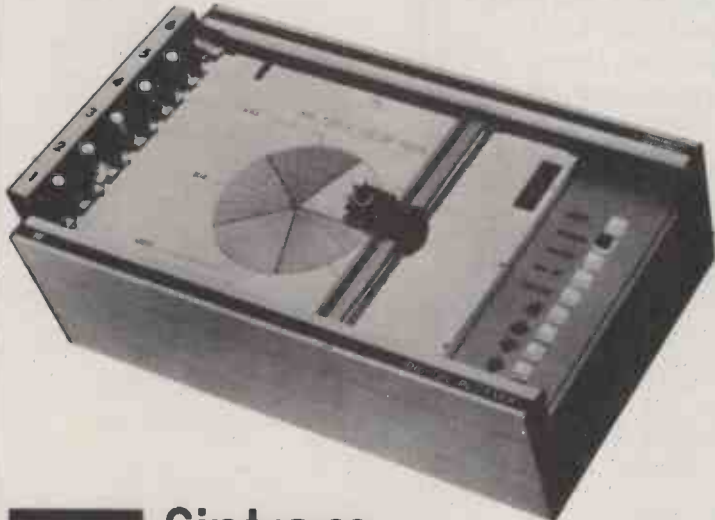

A4 SIZE HI-PLOTS — From £690

Available in standard or intelligent versions with manual or remote controls
Add £3

A3 SIZE HI-PLOTS — From £1085

Available in standard or intelligent versions with manual or remote controls
Add £395 for 8-pen operation

NEW — frame advance versions from £1655



Sintrrom Electronics
YOUR GRAPHICS PERIPHERAL SPECIALIST

Sintrrom Electronics Ltd
Arkwright Road, Reading, Berks RG2 0LS
Tel: Reading (0734) 875464
Telex: 847395

OEM & DEALER ENQUIRIES WELCOME



● Circle No. 175

There's some great new products in the new Willis Catalogue.

- New Mini Disk File
 - New Credit Card Cleaning System
 - New Printer Silencers
 - New VDU Desks
 - New Spinwriter Thimbles and Ribbons
 - New Olivetti Disks and Ribbons
 - New Mariner Diskette Magazine
- PLUS the full range of supplies from Verbatim, Diabolo and Qume.

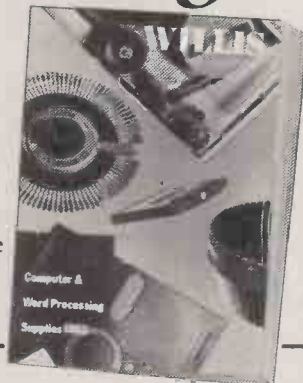

Send for your copy now

Post to: Willis Computer Supplies Limited, FREEPOST, PO Box 10, Southmill Road, Bishops Stortford, Herts. CM23 1BR. Or tel: Bishops Stortford (0279) 506491. Telex: 817425.

Name _____

Company _____

Address _____

Tel. _____

WILLIS

Computer Supplies
for people who know better

PC 8/82

● Circle No. 174

OPEN FRAME MONITORS AVAILABLE FOR OEM'S

The 'PRINCE' of Monitors

offers better Monitoring.

24MHz Bandwidth—ensures a clear crisp display.
Available with P4 White P31 Green AND L1 ORANGE



Scan: 625 lines/50 Hz. Deflection: 110°. Active raster: 240x172mm. Bandwidth (3dB): 10 Hz-24 MHz (at 3dB points). Character display: 80 characters x 24 lines. Horizontal frequency: 15625 Hz ± 0.5 KHz. Vertical frequency: 50 Hz. Horizontal linearity: ± 3%. Vertical linearity: ± 2%. Geometric distortion: ± 1.5%. EHT (at zero beam current): 13kV ± 0.5kV. Power drain: 30 Watt approx. Voltage supply: 110V A.C. 50 Hz/220V A.C. — 50 Hz/240V A.C., 50Hz/ ± 10% upon request. Video input: 2 x BNC — or CINCH — or PL 259. (composite video) negative sync, input 0.5-4V p.p. across 75 Ohms. X-Ray radiation: conforms to I.E.C. Spec. No. 65. Overall dimensions: 320 x 270 x 265 mm. Weight: 7 Kg. approx. Ambient temperature: 0-45°C.

OTHER CROFTON PRODUCTS INCLUDE: Computer peripheral equipment, Frame grabber, Floppy disk drives, Floppy disks, Computer power supplies, C.C.T.V. monitors, Uncased monitors, Monitor P.C.B.'s., Cathode ray tubes, VHF/UHF modulators, Video switchers, Video distribution amplifiers, Camera housings, Pan and tilt units, Camera lens, Camera tubes, Printed circuit board service.

CROFTON ELECTRONICS LTD

35, Grosvenor Road, Twickenham, Middx, TW1 4AD.
Telephone: 01-891 1923/1513 Telex: 295093 CROFTN G

● Circle No. 176

(listing continued from page 127)

```

300 HOME : PRINT "A)BUY"; PRINT "B
)SELL"; PRINT "C)ALTER AMOUNT
ON ORDER"; PRINT "D)EXIT"; GET
MODE$ = IF MODE$ < "A" AND "H
ODES < " > "B" AND MODE$ < "
C" AND MODE$ < " > "D" AND MODE
$ < " > CHR$(3) THEN GOTO 80
0
810 IF MODE$ = CHR$(3) THEN GOTO
210
820 IF MODE$ = "D" THEN GOTO 960
830 HOME
340 HOME : IF MODE$ = "B" AND UAL
(IS$) = 0 THEN PRINT "YOU HAV
E HOME TO SELL"; PRINT : PRINT
"TYPE <SPACEBAR>"; GET AS: HOME
: GOTO 800
850 FLAG = 1
860 IF MODE$ = "A" THEN HOME : INPUT
"NUMBER TO BE BOUGHT ";A:IS$ =
STR$(UAL (IS$) + A); POKE
34,2: HOME :
870 IF MODE$ = "A" THEN IF INU <
> 0 THEN PRINT D$;"PR#1": FOR
J = 1 TO INU: PRINT : PRINT "D
ATE:";DTE$;" BOUGHT:";A;" "DE
$: PRINT : PRINT : PRINT : NEXT
: PRINT D$;"PR#0": GOTO 690
880 IF MODE$ = "A" THEN GOTO 690
890 IF MODE$ = "B" THEN HOME : INPUT
"NUMBER TO BE SOLD ";A: IF A >
UAL (IS$) THEN HOME : PRINT
"YOU DON'T HAVE THAT MANY TO S
ELL": PRINT : PRINT "TYPE <SPA
CEBAR>"; GET AS: GOTO 800
900 IF MODE$ = "B" THEN IS$ = STR$
(UAL (IS$)) - A; POKE 34,2:
HOME
910 IF MODE$ = "B" THEN IF INU <
> 0 THEN PRINT D$;"PR#1": FOR
J = 1 TO INU: PRINT : PRINT "D
ATE:";DTE$;" BOUGHT:";A;" "DE
$: PRINT : PRINT : PRINT : NEXT
: PRINT D$;"PR#0": GOTO 690
920 IF MODE$ = "B" THEN GOTO 690
930 IF MODE$ = "C" THEN HOME : INPUT
"AMOUNT ON ORDER ";A:OOS$ = STR$
(A): HOME
940 IF MODE$ = "C" THEN IF INU <
> 0 THEN PRINT D$;"PR#1": FOR
J = 1 TO INU: PRINT : PRINT "D
ATE:";DTE$;" ORDERED:";A;" "DE
$: PRINT : PRINT : PRINT : NEXT
: PRINT D$;"PR#0": GOTO 690
950 IF MODE$ = "C" THEN GOTO 690
960 IF GN(I) = GN AND PN(I) = PN AND
OES(I) = OES AND CP(I) = CP AND
SP(I) = SP AND IS$(I) = IS$ AND
ML$(I) = ML$ AND OOS(I) = OOS THEN
GOTO 210
970 PRINT : PRINT D$;"OPEN STOCK F
ILE,L60"; PRINT D$;"WRITE STOC
K FILE,R";I
980 PRINT GN: PRINT PN: PRINT OES:
PRINT CP: PRINT SP: PRINT IS$
: PRINT ML$: PRINT OOS: PRINT
D$;"CLOSE"
990 IS$(I) = IS$
1000 GOTO 210
1010 HOME : PRINT "I'H TER
RIBLY SORRY BUT I CAN'T SEEM T
O FIND THAT PRODUCT"
1020 PRINT : PRINT "PERHAPS YOU GA
VE AN INCOMPLETE OR FAULTYDESC
RIPTION,OR A NON EXISTANT PROD
UCT OR RECORD NUMBER"
1030 PRINT : PRINT "PLEASE TYPE <S
PACEBAR>";
1040 GET AS: IF AS < " > " " THEN GOTO
1040
1050 HOME : GOTO 440
1060 TEXT : HOME
1070 FLAG = 0
1080 PRINT TAB(8)"CREATE OR ALTE
R PRODUCTS": PRINT "*****
*****"
1090 POKE 34,2: PRINT
1100 NUMBER = MAX + 1
1110 IF NUMBER > = 1500 THEN HOME
: PRINT "DISK FULL": PRINT "TY
PE <SPACEBAR>";GETAS:GOTO90
1120 HOME : PRINT
1130 IF NUMBER = 450 THEN NUMBER =
NUMBER - 1: PRINT "DISK FULL":
PRINT :FLAG = 9999: GOTO 1150
1140 PRINT "THE NEXT FREE PRODUCT
NO. IS ";NUMBER:PRINT
1150 PRINT "ENTER ";NUMBER;" FOR A
NEW PRODUCT": PRINT
1160 PRINT "ENTER A NUMBER LESS TH
AN ";NUMBER:PRINT "TO ALTER A
N OLD PRODUCT": PRINT
1170 PRINT "ENTER <A> TO SEARCH FO
R AN OLD PRODUCT BY NAME": PRINT
1180 INPUT "WHAT NUMBER DO YOU WAN
T";AS
1190 IF AS = "A" THEN GOTO 1840
1200 IF UAL (AS) < 1 OR UAL (AS)
> NUMBER THEN UTAB (14); GOTO
1180
1210 OLD = NUMBER:NUMBER = UAL (AS
)
1220 MODE$ = "CREATE"
1230 IF FLAG = 9999 THEN HOME : GOTO
1580
1240 MODE$ = "ALTER"
1250 I = NUMBER:GN = GN(I):PN = PN
(I):OES = OES(I):CP = CP(I):SP =
SP(I):IS$ = IS$(I):ML$ = ML$(I
):OOS = OOS(I)
1260 PRINT D$;"CLOSE"
1270 HOME

```

(continued from page 127)

CHR\$(17), Ctrl-Q is the code on the Silentype to print the high-resolution page, and the Pokes on line 110 of the Hello program set the Silentype to uni-directional mode, page 1, and the left margin at 20. The original logo was created by loading the "colossal" from the Dos Toolkit, typing directly on the high-resolution page, being careful to erase the prompts with spaces, pressing Reset, and then typing

Bsave Stock Logo, A\$2000, L8192

The program uses arrays to store the product inventory, and whenever a new product is added to the inventory the program must be rerun as in line 1830. Applesoft does not allow you to re-Dim arrays. The following variables form the inventory:

MAX — current limit to the inventory, 1 to 450
GN(1) to GN(MAX) — group number
PN(1) to PN(MAX) — product number
DES(1) to DES(MAX) — description
CP(1) to CP(MAX) — cost price
SP(1) to SP(MAX) — selling price
ISS(1) to ISS(MAX) — stock level
ML\$(1) to ML\$(MAX) — minimum allowed stock level

OOS(1) to OOS(MAX) — number on order

The index of the arrays refers to the record number of the disc file where the product is stored, in this case 1.

GP — number of groups

GC(1) — used to add up cost

GS(1) — sale values of groups

Record O of the disc file is used to store two pieces of housekeeping information in the following format:

No. of groups: field

Number of products field 2

Set-up routine

Before running the program, this record will have to be set up. A suggested routine is:

```

10 D$=CHR$(13)+CHR$(14):REM(CR)
+Ctrl-D
20 ?D$;"Open Stock File, L50"
30 ?D$;"Write Stock File, R0"
40 ?"00":?"00":
50 ?D$;"Close"
60 END

```

Table 1.

Language card	slot 0 (Irrelevant)
Silentype printer	slot 1
Mountain hardware	
CPS card	slot 4
Disc	slot 6

The program was developed on a micro configured as in table 1. The CPS card has a real-time clock, with batteries to keep it going when the Apple is turned off. If you do not possess one of these cards, or something similar such as the MH-365 Day Clock Card, then replace the subroutine of lines 2950 to 2990 with something like

```

2950 Text: Home
2960 Input "Please enter today's date (eg,
11/11/81)";
2970 IF Len(DTE$) (6 Then goto 2950
2980 Return
2990

```

(continued on next page)

```

1280 IF LEN (DES) > 23 THEN DES =
LEFT$(DES,23)
1290 PRINT "A)GROUP NO.....";GN
1300 PRINT
1310 PRINT "B)PRODUCT NO.....";PN
1320 PRINT
1330 PRINT "C)DESCRIPTION.....";DES
1340 PRINT : UTAB (9)
1350 PRINT "D)COST PRICE.....";CP
1360 PRINT
1370 PRINT "E)SELLING PRICE..";SP
1380 PRINT
1390 PRINT "F)IN STOCK.....";IS$
1400 PRINT
1410 PRINT "G)MINIMUM LEVEL..";ML$
1420 PRINT
1430 PRINT "H)NO. ON ORDER..";OOS
1440 UTAB (20): PRINT : UTAB (20)
1450 PRINT "CHANGE WHICH ONE (<Z TO
END)"; GET AS
1460 IF AS = CHR$(3) THEN GOTO
210
1470 UTAB (20): PRINT "
"; UTAB (20)
1480 IF AS = "A" THEN INPUT "GROU
P NO.....";GN: GOTO 1270
1490 IF AS = "B" THEN INPUT "PROD
UCT NO.....";PN: GOTO 1270
1500 IF AS = "C" THEN INPUT "DESC
RIPTION.....";DES: GOTO 1270
1510 IF AS = "D" THEN INPUT "COST
PRICE.....";CP: GOTO 1270
1520 IF AS = "E" THEN INPUT "SELL
ING PRICE..";SP: GOTO 1270
1530 IF AS = "F" THEN INPUT "IN S
TOCK.....";IS$: GOTO 1270
1540 IF AS = "G" THEN INPUT "MINI
MUM LEVEL..";ML$: GOTO 1270
1550 IF AS = "H" THEN INPUT "ON O
RDER.....";OOS: GOTO 1270
1560 IF AS = "Z" THEN HOME : GOTO
1730
1570 FLAG = 0: GOTO 1450
1580 INPUT "GROUP NO.....";GN
1590 PRINT TAB(16)"NUMBER: HTAB
1: INPUT "PRODUCT NO.....";PN
1600 INPUT "DESCRIPTION.....";DES
1610 UTAB (6)
1620 INPUT "COST PRICE.....";CP
1630 INPUT "SELLING PRICE..";SP
1640 INPUT "IN STOCK.....";IS$
1650 INPUT "MINIMUM LEVEL..";ML$
1660 INPUT "ON ORDER.....";OOS
1670 FLAG = 1
1680 UTAB (20): PRINT "IS THIS ALR
IGHT?"; GET AS: IF AS = "N" THEN
GOTO 1270
1690 HOME
1700 IF LEN (DES) > 23 THEN DES =
LEFT$(DES,23)
1710 PRINT
1720 IF RIGHT$(DES,1) = " " THEN
DES = LEFT$(DES,(LEN (DES) -
1))
1730 I = NUMBER: IF GN(I) = GN AND
PN(I) = PN AND DES(I) = DES AND
CP(I) = CP AND SP(I) = SP AND
ISS(I) = IS$ AND ML$(I) = ML$ AND
OOS(I) = OOS THEN GOTO 210
1740 PRINT : PRINT D$;"OPEN STOCK
FILE,L60"; PRINT D$;"WRITE STO
CK FILE,R";NUMBER
1750 PRINT GN: PRINT PN: PRINT DES
: PRINT CP: PRINT SP: PRINT IS
$: PRINT ML$: PRINT OOS
1760 PRINT D$;"CLOSE"
1770 PRINT D$;"OPEN STOCK FILE,L60"
1780 PRINT D$;"READ STOCK FILE,R0
"; INPUT AS,B$: PRINT D$;"CLOS
E"
1790 IF GN > UAL (AS) THEN AS = STR$
(GN)
1800 IF NUMBER > UAL (B$) THEN B$
= STR$(NUMBER)
1810 PRINT
1820 PRINT D$;"OPEN STOCK FILE,L60
"; PRINT D$;"WRITE STOCK FILE,
R0"; PRINT AS: PRINT B$: PRINT
D$;"CLOSE"
1830 RUN
1840 HOME : PRINT : INPUT "ENTER T
HE DESCRIPTION OF THE PRODUCT
YOU WISH TO FIND(FULL DESCRIPTI
ON PLEASE) ";DES: PRINT
1850 IF LEFT$(DES,1) = " " THEN
DES = RIGHT$(DES,(LEN (DES) -
1)); GOTO 1850
1860 IF RIGHT$(DES,1) = " " THEN
DES = LEFT$(DES,(LEN (DES) -
1)); GOTO 1860
1870 FOR I = 1 TO MAX: IF DES(I) <
> DES THEN NEXT : GOTO 1890
1880 NUMBER = I: GOTO 1250
1890 HOME : PRINT : PRINT "I'H TER
RIBLY SORRY BUT I CAN'T SEEM T
O FIND THAT PRODUCT"
1900 PRINT : PRINT "PERHAPS YOU GA
VE AN INCOMPLETE OR FAULTY DESC
RIPTION,OR A NON EXISTANT PROD
UCT OR RECORD NUMBER"
1910 PRINT : PRINT "PLEASE TYPE <S
PACEBAR>";
1920 GET AS: IF AS < " > " " THEN GOTO
1920
1930 HOME : GOTO 1060
1940 TEXT : HOME
1950 PRINT TAB(14)"STOCK REPORT"
: PRINT "*****
*****"
1960 HOME : PRINT : INPUT "GROUP N
O (<FOR ALL) ";AS:A = UAL (AS
): IF A < 0 OR A > GP THEN GOTO
1960

```

(listing continued on next page)

(listing continued from previous page)

```

1970 Z$ = AS: IF Z$ = "" THEN A =
9999
1980 HOME : PRINT : INPUT "PRINTER
" : AS: IF AS = "Y" THEN PRINT
DS:"PRN1": HOME : GOTO 2160
1990 TEXT : HOME : IF A = 9999 THEN
GOTO 2010
2000 PRINT "GROUP NUMBER " : A: PRINT

2010 PRINT "DESCRIPTION NO
COST SALE*****
*****";

2020 FOR I = 1 TO MAX
2030 IF (GN(I) < > A) AND A < >
9999 THEN NEXT : GOTO 2300
2040 IF LEN (DES(I)) > 19 THEN DE
S =
LEFT$ (DES(I),19): GOTO 2
060
2050 DES = DES(I)
2060 PRINT DES: HTAB (24 - LEN (
IS(I))) : PRINT IS(I)
2070 IF LEN ( STR$ (CP(I))) < 3 THEN
CP$ =
STR$ (CP(I)): CP$ = CP$ +
".00": GOTO 2090
2080 CP$ = STR$ (CP(I)): IF MID$
(CP$, (LEN (CP$) - 2), 1) < >
"." AND MID$ (CP$, (LEN (CP$)
- 1), 1) < > "." THEN CP$ = C
P$ + ".00"
2090 HTAB (33 - LEN (CP$)): PRINT
CP$
2100 IF LEN ( STR$ (SP(I))) < 3 THEN
SP$ =
STR$ (SP(I)): SP$ = SP$ +
".00": GOTO 2120
2110 SP$ = STR$ (SP(I)): IF MID$
(SP$, (LEN (SP$) - 2), 1) < >
"." AND MID$ (SP$, (LEN (SP$)
- 1), 1) < > "." THEN SP$ = S
P$ + ".00"
2120 HTAB (41 - LEN (SP$)): PRINT
SP$
2130 FLAG = FLAG + 1: IF FLAG = 22 THEN
GET AS: FLAG = 0
2140 NEXT
2150 GOTO 2300
2160 IF A = 9999 THEN GOTO 2180
2170 PRINT "THE DATE IS " : JTE$: PRINT
2180 PRINT "DESCRIPTION
GROUP NO SALE:
PRINT "*****
*****"
2190 FOR I = 1 TO MAX
2200 POKE - 12528,5
2210 IF (GN(I) < > A) AND A < >
9999 THEN NEXT : GOTO 2300
2220 PRINT DES(I): C = LEN (DES(I
)): + LEN ( STR$ (GN(I)): PRINT
SPC$ (34 - C): PRINT GN(I)
2230 C = LEN (IS(I)): PRINT SPC$
(09 - C): PRINT IS(I)
2240 IF LEN ( STR$ (CP(I))) < 3 THEN
CP$ =
STR$ (CP(I)) + ".00": GOTO
2260
2250 CP$ = STR$ (CP(I)): IF MID$
(CP$, (LEN (CP$) - 2), 1) < >
"." AND MID$ (CP$, (LEN (CP$)
- 1), 1) < > "." THEN CP$ = C
P$ + ".00"
2260 PRINT SPC$ (18 - LEN (CP$)):
PRINT CP$
2270 IF LEN ( STR$ (SP(I))) < 3 THEN
CP$ =
STR$ (SP(I)) + ".00": GOTO
2290
2280 SP$ = STR$ (SP(I)): IF MID$
(SP$, (LEN (SP$) - 2), 1) < >
"." AND MID$ (SP$, (LEN (SP$)
- 1), 1) < > "." THEN SP$ = S
P$ + ".00"
2290 PRINT SPC$ (19 - LEN (SP$)):
PRINT SP$: NEXT : GOTO 2300

2300 PRINT : PRINT OS:"PRN0": PRINT
"TYPE (SPACEBAR) "
2310 GET AS: IF AS < > " " THEN GOTO
2310
2320 GOTO 210
2330 TEXT : HOME
2340 PRINT TAB (14) "GROUP VALUES"
: PRINT "*****
*****"
POKE 34,
2: PRINT
2350 HOME : PRINT
2360 INPUT "PRINTER " : JMC$: IF HC$ =
"Y" THEN PRINT DS:"PRN1"
2370 PRINT "THE DATE IS " : JTE$: IF
HC$ = "Y" THEN PRINT
2380 HOME
2390 FOR I = 1 TO MAX
2400 GC(GN(I)) = GC(GN(I)) + CP(I) *
VAL ( IS(I) ) : GS(GN(I)) = GS(G
N(I)) + SP(I) * VAL ( IS(I) ):
NEXT
2410 FOR I = 1 TO GP
2420 CO$ = STR$ (GC(I)): IF MID$
(CO$, (LEN (CO$) - 2), 1) < >
"." AND MID$ (CO$, (LEN (CO$)
- 1), 1) < > "." THEN CO$ = C
O$ + ".00"
2430 IF MID$ (CO$, (LEN (CO$) - 2
), 1) < > "." THEN CO$ = CO$ +
".00"
2440 SA$ = STR$ (GS(I)): IF MID$
(SA$, (LEN (SA$) - 2), 1) < >
"." AND MID$ (SA$, (LEN (SA$)
- 1), 1) < > "." THEN SA$ = S
A$ + ".00"
2450 IF MID$ (SA$, (LEN (SA$) - 2
), 1) < > "." THEN SA$ = SA$ +
".00"
2460 PRINT "GROUP " : I: HTAB (1
9): PRINT "COST " : HTAB (24 +
(15 - (LEN (CO$)))) : PRINT CO
$: HTAB (19): PRINT "SALE " : HTAB
(24 + (15 - (LEN (SA$)))) : PRINT
SA$
2470 PRINT
2480 NEXT
2490 PRINT OS:"PRN0": PRINT "TYPE
(SPACEBAR)"
2500 GET AS: IF AS < > " " THEN GOTO
2500

```

(continued from previous page)

Line 2940 is a remnant from an old routine, and can be omitted. Apart from in the Hello program, no special Silen-type features are used.

The following observation about the Apple may be useful if you want to modify the program for other systems:

- It is an Apple DOS requirement that a DOS command is not preceded by a Get command; hence the surfeit of ?s.
- Home clears the text screen and puts the cursor at the top-left position.
- Poke 34, n sets the top limit of the text page at n lines down from the top.
- ? SPC(n) prints n spaces.
- x=PRE(0) performs "house-cleaning" on the Applesoft, plus string storage thus increasing the effective memory.
- CHR\$(4), assigned to D\$ is necessary before a deferred execution
- DOS command.
- On n GOTO a, b, c, d etc, it goes to the nth line number in the list. If n is greater than the number of entries in the list, then the command is ignored.
- CHR\$(13)=Return, Ctrl-M
- CHR\$(3)=Ctrl-C
- CHR\$(4)=Ctrl-D

Do not simply type the program in and run it. The Poke 214, 128 will prevent you from typing errors you should omit the Poke 214, 128 and the Onerr Goto commands at first, only adding them once you are quite sure that the program works.

List before running

Once you have added these commands, save the program before running it. From then on the only way to list the program will be to load the program and list it, not to run it first. A password facility has been added to ensure greater protection. The password is assigned, in line 10, to Pass

Output to screen and printer may be tied up up the following decimal-point line-up routine:

```

10 REM NUMBER IN NU$
20 IF M10$( NU$, (LEN(NU$)-2), 1) < > "
" AND MID$( NU$, (LEN(NU$)-1), 1) < > "
" then
NU$=NU$+ ".00": GOTO 40
30 IF MID$( NU$, (LEN(NU$)-1), 1) = "." then
NU$=NU$+"0"
40

```

In addition, names are rounded up to fit the screen or pointer as appropriate, and leading or trailing spaces are removed. Any screen information is displayed page by page.

The wildcard character = is supported in options 3 and 4 to specify all groups or products. Note that to prevent unnecessary disc wear, if you alter a product and then alter it back again, the program will not bother to update the disc, thus saving time and reducing disc wear.

The Help option runs a file on disc called "help" which may be in the form of an aide-memoire and could be written by the user according to needs. At any point typing Ctrl-C aborts the current operation and sends you back to the menu.

```

2510 GOTO 210
2520 TEXT : HOME
2530 PRINT TAB (10) "STOCK BELOW M
INIMUM": PRINT "*****
*****"
POKE
34,2: PRINT
2540 HOME : PRINT
2550 INPUT "PRINTER " : JMC$: IF HC$ =
"Y" THEN PRINT DS:"PRN1"
: PRINT
2560 PRINT "THE DATE IS " : JTE$: PRINT
: IF LEFT$ (HC$, 1) = "N" THEN
HOME
2570 IF HC$ = "Y" THEN GOTO 2660
2580 PRINT "DESCRIPTION IN S
TOCK MIN LEVEL": IF HC$ =
"Y" THEN PRINT : FOR I = 1 TO
40: PRINT " ": NEXT
2590 FOR I = 1 TO MAX
2600 IF VAL ( IS(I) ) > = VAL ( M
L(I) ) THEN GOTO 2650
2610 IF HC$ = "Y" THEN PRINT : GOTO
2630
2620 IF LEN ( DES(I) ) > 16 THEN PRINT
LEFT$ (DES(I),16): HTAB (27 -
LEN ( IS(I) )) : PRINT IS(I):
HTAB (41 - LEN ( HL(I) )) : PRINT
HL(I): GOTO 2640
2630 PRINT OS:"PRN0": PRINT "
IS(I) : HTAB
(41 - LEN ( HL(I) )) : PRINT HL
(I)
2640 FLAG = FLAG + 1: IF FLAG = 19 AND
HC$ = "N" THEN FLAG = 0: PRINT
"PRESS (SPACEBAR) TO CONTINUE"
: GET AS
2650 NEXT : PRINT OS:"PRN0"
: PRINT "PRESS (SPACEBAR) TO
CONTINUE": GET AS: GOTO 210
2660 PRINT "DESCRIPTION
GROUP NO MIN
COST SALE:
PRINT "*****
*****"
2670 FOR I = 1 TO MAX
2680 IF VAL ( IS(I) ) > VAL ( HL(I
)) THEN NEXT : GOTO 2780
2690 PRINT DES(I): C = LEN (DES(I
)) + LEN ( STR$ (GN(I)): PRINT
SPC$ (34 - C): PRINT GN(I)
2700 C = LEN (IS(I)): PRINT SPC$
(09 - C): PRINT IS(I)
2710 C = LEN (HL(I)): PRINT SPC$
(08 - C): PRINT HL(I)
2720 IF LEN ( STR$ (CP(I))) < 3 THEN
CP$ =
STR$ (CP(I)) + ".00": GOTO
2740
2730 CP$ = STR$ (CP(I)): IF MID$
(CP$, (LEN (CP$) - 2), 1) < >
"." AND MID$ (CP$, (LEN (CP$)
- 1), 1) < > "." THEN CP$ = C
P$ + ".00"
2740 PRINT SPC$ (15 - LEN (CP$)):
PRINT CP$
2750 IF LEN ( STR$ (SP(I))) < 3 THEN
CP$ =
STR$ (SP(I)) + ".00": GOTO
2770
2760 SP$ = STR$ (SP(I)): IF MID$
(SP$, (LEN (SP$) - 2), 1) < >
"." AND MID$ (SP$, (LEN (SP$)
- 1), 1) < > "." THEN SP$ = S
P$ + ".00"
2770 PRINT SPC$ (14 - LEN (SP$)):
PRINT SP$: NEXT : GOTO 2780

2780 PRINT : PRINT OS:"PRN0": PRINT
"TYPE (SPACEBAR) "
2790 GET AS: IF AS < > " " THEN GOTO
2310
2800 GOTO 210
2810 HOME : PRINT "AUTOMATIC INVOI
CING: NO: NUMBER OF COPIES " : J: GET
AS
2820 PRINT AS: GET X$
2830 IF AS = "N" THEN INU = 0: GOTO
210
2840 INU = VAL ( AS ): GOTO 210
2850 PRINT "NOT AVAILABLE " : J: GET
AS: GOTO 70
2860 HOME : PRINT "PLEASE TYPE C$P
ACERBAR): "
2870 GET AS: IF AS < > " " THEN GOTO
2870
2880 PRINT
2890 PRINT OS:"RUN HELP"
2900 TEXT : HOME
2910 PRINT "DO YOU WANT TO LEAVE A
PPLE STOCK? " : J: GET AS: IF AS < >
"Y" THEN RUN
2920 HOME : HTAB (12): PRINT TAB (
15) "BWEI"
2930 END
2940 PRINT "OPEN STOCK FILE, L60":
PRINT "WRITE STOCK FILE, R0": PRINT
"02": PRINT "04": PRINT "CLOSE
"
2950 PRINT OS:"PRN4": PRINT DS:"IN
4": PRINT "C": INPUT CO$: PRINT
DS:"PRN0": PRINT OS:"IN40"
2960 TH$(0) = "SUNDAY": TH$(1) = "MO
NDAY": TH$(2) = "TUESDAY": TH$(3
) = "WEDNESDAY": TH$(4) = "THUR
SDAY": TH$(5) = "FRIDAY": TH$(6)
= "SATURDAY"
2970 DIM DH$(12): DH$(1) = "JANUARY"
: DH$(2) = "FEBRUARY": DH$(3) =
"MARCH": DH$(4) = "APRIL": DH$(5
) = "MAY": DH$(6) = "JUNE": DH$(
7) = "JULY": DH$(8) = "AUGUST":
DH$(9) = "SEPTEMBER": DH$(10) =
"OCTOBER": DH$(11) = "NOVEMBER"
: DH$(12) = "DECEMBER"
2980 DT$ = TH$( VAL ( LEFT$ (CO$, 2
)) ) + " " + MID$ (CO$, 6, 2)
)) + " " + DH$( VAL ( MID$ (CO$, 3, 2
)) ) + " " + "19" + MID$ (CO$,
9, 2)
2990 RETURN
3000 FOR I = LEN (OS) TO 1 STEP -
1: INVERSE : PRINT MID$ (OS, I
): NORMAL : PRINT MID$ (
AS, I): NEXT : RETURN

```

★ Limited Dealerships Available

£2975 !!
or lease from under £15.00 per week
YES, THE DESK'S INCLUDED!



EXPRESS WORD PROCESSING SYSTEM

with free business computer

- ★ Separate keyboard with 24 special function keys for fast processing ★
- ★ Green screen — less eyestrain ★
- ★ WORDSTAR — the most popular, proven word processing software available ★
- ★ Daisy wheel printer — high quality letter printing ★
- ★ Customised work station ★
- ★ British made micro computer ★



EMPIRE
Computer Systems Ltd
40 Triton Square
London NW1 3HG
01-387 4599

NAME	
POSITION	
COMPANY	
ADDRESS	
PHONE	

EXPAND YOUR HORIZONS



S100 SYSTEMS

All systems based on the North Star Horizon.

MULTI-USER

Up to 7 users can be accommodated.

5¼ WINCHESTER DRIVES

21 Mb is now available on high speed drive S100 systems.

Drives also available for the Altos and N.E.C.

NEW MULTIPROCESSOR SYSTEMS

A new price breakthrough at £395.00 per board (Z80 64K R.T.C. 2 serial one parallel port).

APPLICATIONS SOFTWARE

We guarantee all our software and provide full support.

LOW COST S100 BOARDS

For graphics, memory and serial I/O.

WHY NOT TAKE THE ADVANTAGE...

The new exciting microcomputer in the North Star range. We have a good stock of C.P.U.s plus hardware and software.

PERIPHERALS

A comprehensive range of printers and V.D.U.s to cater for most needs including Epson, Televideo and N.E.C.

MAINTENANCE

A cost effective reliable service for the Business Microsystem—we make them work.

Head for the North Star, head for...

Novel 69 Loudoun Road · London NW8 0DQ
Telephone 01-328 8737/8
Telex 266828 HMS-G. NorthStar 
MICROSYSTEMS LTD.

Open File

This regular section of *Practical Computing* appears in the magazine each month, incorporating Tandy Forum, Apple Pie, ZX-80/81 Line-up and the other software interchange pages.

Open File is the part of the magazine written by you, the readers. All aspects of microcomputing are covered, from games to serious business and technical software, and we welcome contributions on CP/M, BBC Basic, Microsoft Basic, Apple Pascal and so on, as well as the established categories.

Each month the best contribution will be awarded £20; others receive £6. Send contributions to: **Open File, Practical Computing, Quadrant House, The Quadrant, Sutton, Surrey SM2 5AS.**



Petcout

MICROCOMPUTERS HAVE adopted two ways on moving the cursor within a Basic program. notes M Phillips of Knutsford.

Apple Pie: Petcout for cursor control; Graphics print routine; Disc patcher and contents	133
ZX-80/81 Line-up: Command-exchange routine; Physics calculations; Income-tax assessment; Hexad editor/assembler	141
6502 Special: Plakoto game; Print At facility	143
BBC Bytes: Multicoloured text; Music function; Hyperbolic calculations; Fighter game	149
Tandy Forum: Animation; Space orbit; Telephone-bill calculator	151
Disc Dialogue: Recovering from BDOS error; Paging text files; MBasic renumber routine	157
Pet Corner: Quick formatter; Dodgeball game; Exchanging ROMs without damage	159



Guidelines for contributors

Programs should be accompanied by documentation which explains to other readers what your program does and, if possible, how it does it. It helps if documentation is typed or printed with double-line spacing — cramped or handwritten material is liable to delay and error.

Program listings should, if at all possible, be printed out. Use a new ribbon in your

printer, please, so that we can print directly from a photograph of the listing and avoid typesetting errors. If all you can provide is a typed or handwritten listing, please make it clear and unambiguous; graphics characters, in particular, should be explained.

We can accept material for the Pet, Vic and Sharp MZ-80K on cassette, and material for the larger machines can be sent on IBM-format 8in. floppy discs.

Cheshire. It may be absolute like Applesoft's VTab and HTab, or relative like Pet's cursor-control characters. Each method has its advantages, and the owner of one can always program the other, but it seems silly not to have the control characters in Applesoft when the appropriate routines already exist within the monitor ROM to perform on-screen editing.

Petcout, a short 6502 subroutine, can be used to provide this feature. Once initialised by Brun or Bload followed by Call 768, it compares all output characters with a list given in the table at the base of the program. If it finds a match, it jumps to the given address for that character. If not, it jumps to the normal character output routine at \$FDF0.

The table listed provides up, left, right, inverse, normal and home; cursor-down is already provided with Ctrl-J. You can

use any codes and monitor, or your own routines as long as the table ends with F0, FD, 00 and contains no more than 85 definitions.

Petcout.

```

1  * 'PETCOUT' APPLE II UTILITY
2  *
3  * TRAPS CONTROL CHARS GIVEN IN
4  * 'TABLE' BELOW AND JUMPS TO
5  * CORRESPONDING ADDRESS TO PROVIDE
6  * CURSOR CONTROL THRU' CHR$ IN
7  * A SIMILAR MANNER TO THE PET
8  *
9  * MAX PHILLIPS DEC 81
10 *
11 * EQUATES ...
12 *
13 ACC     EDU  $45
14 IOSAVE  EDU  $FF4A
15 IDREST  EDU  $FF3F
16 *
17 * THIS VERSION AT $300
18 * PROGRAM CAN BE RELOCATED
19 * IF REFERENCES TO ENTER & VECTL/H CHANGED
20 *
21         ORG  $300
22         OBJ  $300
23 *
24 * INITIALISE
25 *
26 * BRUN THE PROGRAM OR CALL 768 TO
27 * SEND ALL OUTPUT THRU' THIS ROUTINE
    
```

(continued on page 135)

IF IT WASN'T FOR THE LOWEST PRICES, THE BIGGEST CHOICE, AND THE BEST AFTER SALES SERVICE WE JUST WOULDN'T BE COMP SHOP.

THE SHARP MZ80B SYSTEM

MZ80B

● 4 Mhz Z-80A CPU ● 64K RAM ● 2K ROM ● BASIC is provided ● High Resolution Graphics ● 9" High Focus Green Display ● Upper and Lower Case ● 80/40 Characters x 25 line display ● Electro Magnetic Cassette Deck included ● ASC11 Keyboard ● Numeric Keypad ● Sound Output ● Built-in Clock and Music.

● Editing — Cursor Control, Up, Down, Left, Right, Clear and Home. Insertion and deletion Keys.

£949 + VAT



EXTENDED GUARANTEE BY COMPCARE

PRINTER MZ80P6 £449 + VAT
 ● Serial Dot Matrix ● Tractor and Friction Feed
 ● 80 Characters per Second ● Print Capacity 80 col (Normal) 40 col (Double Size) 136 col (Reduced Size)
 ● Upper and Lower case ● Graphics

FLOPPY DISK DRIVE MZ80FB

£699 + VAT
 inc. DOS, Interface Card & Cable

● Dual Drive Unit 5.25"
 ● Dual Sided Double Density
 ● 70 Track, Soft Sectors;
 ● 16 Sectors per Track
 ● 280K Bytes per Diskette

EXTENDED GUARANTEE BY COMPCARE

THE GENIE SYSTEM

Ideal for small businesses, schools, colleges, homes, etc. Suitable for the experienced, inexperienced, hobbyist, teacher, etc.

GENIE I

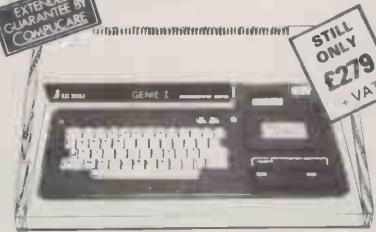

EXTENDED GUARANTEE BY COMPCARE

STILL ONLY £279 + VAT

NOW INCLUDED: Sound, Upper and lower case, Extended BASIC and Machine Code enabling the Writing and Execution of Machine Codes Programming direct from Keyboard.

16K RAM. 12K Microsoft BASIC Extensive Software Range. Self-Contained PSU UHF Modulator Cassette. External Cassette Interface. Simply plugs into TV or Monitor. Complete and Ready to Go. Display is 16 lines by 32 or 64 Characters Switchable. 3 Manuals included, Users Guide, Beginners Programming and BASIC Reference Manual. BASIC Program Tape Supplied. Pixel Graphics.

GENIE II



EXTENDED GUARANTEE BY COMPCARE

£299 + VAT

The NEW GENIE II an ideal Business Machine. 13K Microsoft BASIC in ROM. 71 Keyboard. Numeric Keypad. Upper & Lower Case. Standard Flashing Cursor. Cassette Interface 16K RAM Expanded externally to 48K.

GENIE I & II EXPANSION UNIT WITH 32K RAM £199 + VAT

PARALLEL PRINTER INTERFACE CARD £35.00 + VAT



TEAC DISK DRIVES

EXTENDED GUARANTEE BY COMPCARE

- TEAC FD-50A has 40 tracks giving 125K Bytes unformatted single density capacity.
- The FD-50A can be used in double density recording mode.
- The FD-50A is Shugart SA400 interface compatible.
- Directly compatible with Tandy TRS80 expansion interface.
- Also interfaces with Video Genie, SWTP, TRS80, ATOM, and BBC. Superbrain, Nascom, etc, etc.
- Address selection for Daisy chaining up to 4 Disks.
- Disks plus power supply housed in an attractive grey case.

40 TRACK
 Single Disk Drive £199 + VAT Double Disk Drive £379 + VAT

77 TRACK
 Single Disk Drive £279 + VAT Double Disk Drive £499 + VAT

2 Drive Cable - £15.00 + VAT
 4 Drive Cable - £25.00 + VAT

COMMODORE VIC-20

PLUS FREE GAMES CASSETTES



£173 + VAT

EXTENDED GUARANTEE BY COMPCARE

- 16 foreground colours
- 8 background colours
- Real typewriter keyboard with full graphics
- Music in three voices and three octaves
- Language and sound effects

ALSO AVAILABLE

GAMES CARTRIDGES £17.35 + VAT

16K RAM CARTRIDGE £65.17 + VAT

JOYSTICKS £6.52 + VAT

THE EPSON MX SERIES



- 40/80/132 Column
- Centronics Parallel
- Bi-directional
- Upper & lower case
- True Descenders
- 9x9 Dot Matrix
- Condensed and Enlarged Characters
- Interfaces and Ribbons available

MX80F/T2 £419 + VAT **MX80T** £329 + VAT
MX80F/T £379 + VAT

CENTRONICS DOT MATRIX PRINTERS



737 £369 } + VAT
739 £469 }

Standard Features

- Proportional Spacing
- Right Margin Justification
- 3 way paper handling
- Upper and lower case
- True Descenders
- Bi-directional Paper Mode
- Underlining capability
- Condensed/Expanded Print
- Sub-Scripts and Super Scripts
- Pin and Friction Feed
- 80/132 Column

739 as above with special feature of Dot Resolution Graphics.

HITACHI PROFESSIONAL MONITORS



9" - £129 £99.95 } + VAT
 12" - £199 £149 }

- Reliability Solid state circuitry using an IC and silicon transistors ensures high reliability.
- 500 lines horizontal resolution Horizontal resolution in excess of 500 lines is achieved in picture center.
- Stable picture Even played back pictures of VTR can be displayed without jittering.
- Looping video input Video input can be looped through with built-in termination switch.
- External sync operation (available as option for U and C types)
- Compact construction Two monitors are mountable side by side in a standard 19-inch rack.

THE NEW SHARP MZ-80A

● 280 CPU
 ● 48K RAM
 ● 40 Character x 25 line Display

- Built in 9" High Focus Green Display
- Built in Audio Cassette Deck: Data Transfer 1200 bits/sec
- ASCII Keyboard, Upper & Lower Case, Graphic Symbols, Numeric Keypad
- Editing, Cursor Control (Up, Down, Left, Right, Home, Clear, Deletion Keys)
- Built in Clock & Music

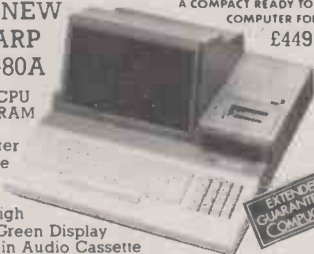

A COMPACT READY TO RUN COMPUTER FOR ONLY £449 + VAT

EXTENDED GUARANTEE BY COMPCARE

We give a full one year's guarantee on all our products, which normally only carry 3 months guarantee.

EXTENDED GUARANTEE BY COMPCARE

COMP SHOP LTD

"Europe's Largest Discount Personal Computer Stores"

TELEPHONE SALES

OPEN 24 hrs. 7 days a week
 01-449 6596

All prices quoted are exclusive of VAT. Delivery is added at cost. Please make cheques and postal orders payable to COMP SHOP LTD., or phone your order quoting BARCLAYCARD, ACCESS, DINERS CLUB or AMERICAN EXPRESS number.



CREDIT FACILITIES AVAILABLE - send S.A.E. for application form.

MAIL ORDER SHOP

14 Station Road, New Barnet, Hertfordshire, EN5 1QW
 (Close to New Barnet BR Station - Moorgate Line)
 Telephone: 01-441 2922 (Sales) 01-449 6596
 Telex: 298755 TELCOM G
 OPEN (BARNET) - 10am - 7pm - Monday to Saturday

311 Edgware Road, London W2
 Telephone: 01-262 0387
 OPEN (LONDON) - 10am - 6pm - Monday to Saturday

● Circle No. 179

(continued from page 133)

```

28 *
29 * ROUTINE TURNED OFF BY RESET OR PRE0
30 *
0300: A9 0B 31 BRUN LDA E&ENTER
0302: 85 36 32 STA #36
0304: A9 03 33 LDA E&ENTER
0306: 85 37 34 STA #37
0308: 4C EA 03 35 JMP #3EA ; EXIT THRU' DOS
36 *
37 * ENTER
38 *
39 * ALL OUTPUT PASSED TO HERE IN ACC
40 *
030B: 20 4A FF 41 ENTER JSR IOSAVE ; SAVE THE REGS
030E: A5 45 42 LDA ACC ; RECOVER ACC'S VALUE
0310: 29 7F 43 AND E&7F ; CLEAR MSB OF ACC
0312: 8D 36 03 44 STA TEMP ; READY FOR COMPARISON
45 *
0315: A0 FF 46 LDY E&FF ; INIT TABLE INDEX
47 *
0317: C8 48 LOOP INY
0318: B9 39 03 49 LDA TABLE,Y ; SET UP NEXT VECTOR
031B: 8D 37 03 50 STA VECTL
031E: C8 51 INY
031F: B9 39 03 52 LDA TABLE,Y
0322: 8D 38 03 53 STA VECTH
0325: C8 54 INY
0326: B9 39 03 55 LDA TABLE,Y ; GET NEXT CHAR
0329: F0 05 56 BEQ DONE ; IF 0 THEN END OF TABLE
032B: CD 36 03 57 CMP TEMP ; IS CHAR TO PRINT ?
032E: D0 E7 58 BNE LOOP ; IF NO, TRY NEXT ENTRY
0330: 20 3F FF 59 JSR IOREST ; RESTORE REGS
0333: 6C 37 03 60 JMP (VECTL) ; EXIT THRU' VECTOR
61 *
62 * DATA STORAGE LDCS
63 *
0336: 00 64 TEMP HEX 00
0337: 00 65 VECTL HEX 00
0338: 00 66 VECTH HEX 00
67 *
68 * TABLE
69 *
70 * LIST OF DESTL,DEATH,ASCII OF CHAR TO TRAP
71 *
72 * MUST END WITH F0,FD,00 SO OTHERS GO TO NORMAL
73 * PRINTING ROUTINE AT #FD0
74 *
0339: 1A FC 17 75 TABLE HEX 1A,FC,17 ; UP CTRL-W #FC1A
033C: 10 FC 19 76 HEX 10,FC,19 ; <- CTRL-Y #FC10
033F: F4 FB 1A 77 HEX F4,FB,1A ; -> CTRL-Z #FBF4
0342: 58 FC 0C 78 HEX 58,FC,0C ; CLS CTRL-L #FC58
0345: 80 FE 09 79 HEX 80,FE,09 ; RVS CTRL-I #FE80
0348: 84 FE 0E 80 HEX 84,FE,0E ; NML CTRL-N #FE84
034B: F0 FD 00 81 HEX F0,FD,00 ; OTHERS TO #FD0

```

Graphics print — listing 1.

```

10 Y = 0: X = 0
20 MC = 7936: REM MACHINE CODE R.
   OUTINE
30 TABLE = 8176
40 PD = - 16240: REM PRINTER BU
   FFER
50 PR = - 15873: REM PRINTER RE
   ADY BYTE
60 D# = CHR#(4):FB = 8192
70 GOSUB 5000
80 TEXT
90 HOME : PRINT "NORMAL (N) : WH
   ITE GOES TO BLACK.
"
100 PRINT "INVERSE (I) : WHITE G
   OES TO WHITE."
110 PRINT : PRINT "WHICH MODE (N
   /I) ?": GET A#: PRINT A#
120 TT = 0: IF A# = "I" THEN TT =
   255
130 POKE 7968,TT: REM SET ON/OFF
   F FLAG
140 HGR2 : HGR : HOME : VTAB 22
150 INPUT "WHAT PICTURE NAME?":N#
160 PRINT D#:"BLOAD":N#;"",A#2000
   "
170 HOME : VTAB 22
180 PRINT "FRAME (Y/N) ?": GET
   A#: PRINT A#: IF A# < > "Y"
   THEN 200
190 HCOLOR= 3: HPL0T 0,0 TO 279,
   0 TO 279,191 TO 0,191 TO 0,0
200 PRINT D#:"PR#1": POKE - 163
   02,0
210 POKE PD,8: REM SET GRAPHIC
   S MODE ON PRINTER
220 FOR Y1 = 0 TO 192 STEP 7
230 FOR Y = Y1 TO Y1 + 6: GOSUB
   1000:BY - Y1) = BV: NEXT
240 FOR X1 = 0 TO 39 STEP 10
250 IF PEEK (PR) < > 132 THEN
   250
260 POKE PD,27: POKE PD,16: POKE
   PD,(7 * X1 > 255) : POKE PD,7
   * X1 - 256 * (7 * X1 > 255)
270 REM 27,16,HP,LP POSITIONS P
   RINTHEAD AT HP*256 + LP
280 FOR X = X1 TO X1 + 9
290 FOR Y = 0 TO 6: POKE TABLE +
   Y, PEEK (BY) + X): NEXT
300 CALL MC
310 NEXT : POKE PD,20: REM PRIN
   T CHARACTERS IN BUFFER
320 NEXT X1
330 IF PEEK (PR) < > 132 THEN
   330
340 POKE PD,10
350 NEXT Y1
360 PRINT D#:"PR#0"
370 TEXT
380 HOME : VTAB 22: PRINT "ANOTH
   ER PICTURE ?": GET A#: PRINT
   A#
390 IF A# < > "N" THEN TEXT : GOTO
   90
400 END
1000 REM FIND BYTE CONTAINING X
   ,Y
1010 LH = X:LV = Y
1020 BV = (LV - INT (LV / 8) * 8
   ) * 1024
1030 BA = INT (LV / 8):BV = BV +
   (BA - INT (BA / 8) * 8) * 1
   28 + INT (LV / 64) * 40 + F
   B
1040 RETURN
5000 REM CREATE MACHINE CODE RO
   UTINE
5010 DATA 160,7,162,6,94,240,31,
   42,202,16,249,77,32,31,9
5020 DATA 128,141,144,192,173,25
   5,193,201,132,208,249,136,20
   8,229,96
5030 FOR T = 7936 TO 7965: READ
   X: POKE T,X: NEXT
5040 RETURN
65535 REM HI-RES GRAPHICS DUMP
65535 REM TO SEIKOSHA GP-80A
65535 REM BY G.WATSON

```

Graphics print

THIS ROUTINE from Greg Watson of Manchester dumps the Apple's high-resolution page 1 to the Seikosha GP-809 printer. The program assumes that the interface card used is the Apple interface and that the interface is in slot 1.

Type in the Basic program in listing 1. Save it and Run the program. You will be asked if you want Normal or Inverse mode: Normal mode means that if a point is set on the screen it will also be set on the printer.

You are then asked for the name of the picture you want printed. It must be the name of a binary file on the disc. To save a high-resolution screen to disc type BSAVE name, A\$2000, L\$2000

Once the picture has been loaded you have the option of having it "framed", and the program then dumps the screen on to the printer. Finally you have the option of another print.

The routine at 1000 returns the address of the byte which contains the point X, Y on the screen. The machine-code routine in listing 2 speeds up the bit manipulation required, since Basic is very slow in that task. Since the character buffer can only hold 90 characters at a time, each line has to be broken up into four segments, which is done by the repositioning sequence in line 260.

Disc patcher

THIS PROGRAM by P McPoland of Bristol has proved useful in debugging programs which manipulate disc files, since it allows you to easily display, print and

(continued on next page)

Graphics print — listing 2.

```

1 ORG #1F00
2 *****
3 *
4 * SEIKOSHA *
5 *
6 * HI-RES GRAPHICS *
7 *
8 * BY G.WATSON *
9 * *****
10 *****
11 BYTES EQU #1FF0
12 PREADY EQU #C1FF ;#CNFF N=SLOT
13 PDATA EQU #C090 ;#C0N0 N=#8 + SLOT
14 ONOFF EQU #1F20 ;BIT MASK
15 LDY #07
16 LOOP LDX #06
17 LOOP1 LSR BYTES,X ;7 BITS AT A TIME
18 ROL A ;GET NEXT BIT FROM BYTE
19 DEX ;SHIFT BIT INTO ACCUMULATOR
20 BPL LOOP1 ;HAVE WE DONE LOOP 7 TIMES?
21 EOR ONOFF ;NO SO REPEAT LOOP1
22 ORA #80 ;SET BITS ON OR OFF FOR NORMAL/INVERSE
23 STA PDATA ;SET M.S.BIT TO MAKE IT GRAPHICS DATA
24 PREADY LDA PREADY ;SEND TO PRINTER BUFFER
25 CMP #84 ;CHECK PRINTER IS READY FOR NEXT BYTE
26 BNE CHECK ;NOT READY THEN CHECK AGAIN
27 DEY ;HAVE WE DONE MAIN LOOP 7 TIMES?
28 BNE LOOP ;NO SO GO BACK TO LOOP
29 RTS ;YES SO RETURN TO PROGRAM.

```

Disc patcher.

```

10 REM
11 REM D K P A T C H - DISK PATCH UTILITY
12 REM COPYRIGHT P MC POLAND 1982
13 REM
20 GOSUB 42000
30 GOSUB 61000
40 DN F GOSUB 20000,21000,22000,23000,24000,25000,26000,27000
50 GOTO 30
10000 REM
10001 REM DISPLAY BUFFER
10002 REM
10010 IF F < > 3 THEN HOME
10015 OF = SP - 38400: FOR I = 1 TO INT (LN / 8): GOSUB 10100: PRINT Z%: "
10020 FOR J = 0 TO 3: FOR K = 0 TO 1: Z = PEEK (SP + 2 * J + K): Z% = MID$ (HX$,
1 + INT (Z / 16), 1) + MID$ (HX$, 1 + Z - 16 * INT (Z / 16), 1): PRINT "NEXT
T K: PRINT " ": NEXT J: PRINT " ": NEXT I: GOTO 10030
10030 PRINT " ": FOR J = 0 TO 7: Z = PEEK (SP + J): IF Z = 0 THEN Z% = " ":
GOTO 10050
10040 Z% = MID$ (TR$, Z, 1)
10050 PRINT Z%: NEXT J: PRINT " ": GOSUB 10100: PRINT Z%: IF F = 3 THEN PR
INT
10055 SP = SP + 8: NEXT I
10060 PRINT "TRACK "T": SECTOR "S": RETURN
10100 Z% = STR$ ((I - 1) * 8 + OF)
10110 IF LEN (Z%) < 3 THEN Z% = "0" + Z%: GOTO 10110
10120 RETURN
20000 REM
20001 REM READ A SECTOR
20002 REM
20010 GOSUB 60000: POKE 801, 1: CALL 769: IF PEEK (768) < > 0 THEN HOME : VTA
B 10: HTAB 14: FLASH: PRINT "I/O ERROR": RETURN
20020 SP = 38400: LN = 128: GOSUB 10000: RETURN
21000 REM
21001 REM WRITE A SECTOR
21002 REM
21010 GOSUB 60000: POKE 801, 2: CALL 769: IF PEEK (768) < > 0 THEN HOME : VTA
B 10: HTAB 14: FLASH: PRINT "I/O ERROR": RETURN
21020 RETURN
22000 REM
22001 REM PRINT A SECTOR
22002 REM
22010 PRINT D% "PR#1": CHR$ (13): CHR$ (10): POKE 1657, 80
22020 SP = 38400: LN = 256: GOSUB 10000
22030 PRINT D% "PR#0": RETURN
23000 REM
23001 REM CHANGE DATA
23002 REM
23010 VTAB 19: HTAB 1: INPUT "OFFSET(0-255)?: "Z%: IF LEN (Z%) = 0 THEN PRINT
B%: GOTO 23010
23020 FOR I = 1 TO LEN (Z%): IF MID$ (Z%, I, 1) < "0" OR MID$ (Z%, I, 1) > "9" T
HEN PRINT B%: GOTO 23010
23025 NEXT I
23030 J = VAL (Z%): IF J > 255 THEN PRINT B%: GOTO 23010
23040 K = 255 - J: IF K > 14 THEN K = 14
23050 Z% = " ": FOR I = J TO J + K: Z = PEEK (38400 + I): Z% = Z% + MID$ (HX$, 1 +
INT (Z / 16), 1) + MID$ (HX$, 1 + Z - 16 * INT (Z / 16), 1)
23060 NEXT I: VTAB 20: HTAB 1: PRINT "OLD DATA "Z%
23070 VTAB 21: HTAB 1: INPUT "NEW DATA? "Z%: IF LEN (Z%) = 0 OR LEN (Z%) > 3
OR LEN (Z%) - 2 * INT (LEN (Z%) / 2) > 0 OR LEN (Z%) > 2 * (K + 1) THEN
PRINT B%: GOTO 23070
23080 FOR I = 1 TO LEN (Z%): FOR K = 1 TO LEN (HX%): IF MID$ (Z%, I, 1) < >
MID$ (HX%, K, 1) THEN NEXT K: PRINT B%: GOTO 23070
23090 NEXT I
23100 FOR I = 1 TO LEN (Z%): FOR K = 1 TO LEN (HX%): IF MID$ (Z%, I, 1) < >
MID$ (HX%, K, 1) THEN NEXT K
23110 Z = 16 * (K - 1) + I - 1: FOR K = 1 TO LEN (HX%): IF MID$ (Z%, I, 1) <
> MID$ (HX%, K, 1) THEN NEXT K
23120 Z = Z + K - 1: POKE 38400 + J + I / 2 - 1, Z: NEXT I

```

```

23130 SP = 38400: IF J > 127 THEN SP = 38528
23140 LN = 128: GOSUB 10000: RETURN
24000 REM
24001 REM RESET DEFAULT DRIVE
24002 REM
24010 VTAB 19: HTAB 1: INPUT "DRIVE(1 OR 2)? "D: IF D < > "1" AND D <
> "2" THEN PRINT B%: GOTO 24010
24020 VTAB 19: HTAB 1: CALL - 958: D = VAL (D): POKE 791, D: POKE 805, D: RETU
RN
25000 REM
25001 REM END PROGRAM
25002 REM
25010 POP : HOME : NEW
26000 REM
26001 REM SHOW SECOND SEGMENT
26002 REM
26010 SP = 38528: LN = 128: GOSUB 10000: RETURN
27000 REM
27001 REM SHOW FIRST SEGMENT
27002 REM
27010 SP = 38400: LN = 128: GOSUB 10000: RETURN
60000 REM
60001 REM RESET TRACK/SECTOR
60002 REM
60010 VTAB 19: HTAB 1: INPUT "TRACK(0-34)? "T: IF LEN (T%) = 0 THEN RETURN
N
60020 FOR I = 1 TO LEN (T%): IF MID$ (T%, I, 1) < "0" OR MID$ (T%, I, 1) > "9"
THEN PRINT B%: GOTO 60010
60030 T = VAL (T%)
60040 POKE 793, T
60050 VTAB 20: HTAB 1: INPUT "SECTOR(0 TO 15)? "S: IF LEN (S%) = 0 THEN P
RINT B%: GOTO 60050
60060 FOR I = 1 TO LEN (S%): IF MID$ (S%, I, 1) < "0" OR MID$ (S%, I, 1) > "9"
THEN PRINT B%: GOTO 60050
60070 S = VAL (S%)
60080 POKE 794, S: RETURN
61000 REM
61001 REM INPUT FUNCTION
61002 REM
61010 NORMAL: VTAB 19: HTAB 1: CALL - 958
61020 HTAB 7: PRINT "ENTER FUNCTION "
61030 INVERSE: HTAB 7: PRINT "R": NORMAL: PRINT "EAD " : INVERSE: PRINT "
D": NORMAL: PRINT "RIVE"
61040 HTAB 7: INVERSE: PRINT "W": NORMAL: PRINT "RITE " : INVERSE: PRINT "
F": NORMAL: PRINT "ORWARD"
61050 HTAB 7: INVERSE: PRINT "P": NORMAL: PRINT "RANGE" : INVERSE: PRINT "
B": NORMAL: PRINT "ACK"
61060 HTAB 7: INVERSE: PRINT "C": NORMAL: PRINT "HANGE"
61070 HTAB 7: INVERSE: PRINT "E": NORMAL: PRINT "XIT"
61080 VTAB 19: HTAB 26: INPUT "F: IF LEN (F%) > I THEN PRINT B%: GOT
O 61080
61090 FOR F = 1 TO LEN (F%): IF MID$ (F%, F, 1) < > F% THEN NEXT F: PRINT B%
: GOTO 61080
61100 IF F < > 3 THEN VTAB 19: HTAB 1: CALL - 958
61110 RETURN
62000 REM
62001 REM INITIALISATION
62002 REM
62003 HOME: VTAB 8: HTAB 11: INVERSE: PRINT "DISK PATCH UTILITY": NORMAL: PR
INT: HTAB 15: PRINT "WRITTEN BY": PRINT: HTAB 12: PRINT "P MC POLAND 1982"
62005 F% = "RWPCDEFB": B% = CHR$ (7): D% = CHR$ (4)
62010 TR% = "0123456789:ABCDEFGHIJKLMNPRSTUVWXYZ" + CHR$ (162) + CHR$ (184) + CHR$
(221) + CHR$ (222) + CHR$ (223) + "ABCDEFGHIJKLMNPRSTUVWXYZ....."
62015 TR% = RIGHTS (TR%, 127) + TR%: HX% = "0123456789ABCDEF"
62020 FOR I = 768 TO 809: READ J: POKE I, J: NEXT I
62030 RETURN
62040 DATA 0, 169, 0, 141, 0, 3, 169, 3, 160, 21, 32, 217, 3, 144, 5, 169, 1, 141, 0, 3, 96
62050 DATA 1, 96, 1, 0, 0, 0, 38, 3, 0, 150, 0, 0, 0, 0, 96, 1, 0, 1, 239, 216

```

(continued from previous page)

change the contents of any Disc II sector directly. Other uses to which it might be put include rescuing deleted files, or patching machine code or data files on disc.

Disc sectors are read into part of the standard DOS buffer area, edited there, and rewritten on demand. Options are selected from a menu by entering the first character of the keywords displayed. They are:

Read — You will be prompted for the track, 0 to 34, and sector, 0 to 15. The sector is then read in and displayed. Note that by pressing Return on the track prompt, you can cause the program to use whatever values are currently in track/sector. At start-up, both values will be zero.

Write — You are prompted for track/sector as for the Read option. Usually you would wish to rewrite the current sector, so you would press Return at the track prompt. The program writes the buffer to the track/sector location specified.

Print — If you have a printer, the program can produce a listing of the sector buffer. Line 22010 sets up for a printer in slot 1, and the Poke is used to suppress screen display during printing, which would otherwise corrupt the display format. It applies to the MX-80 printer interface, so for other printers you would have to replace it with something equivalent.

Drive — This option allows you to set the current disc drive to 1 or 2, whatever you reply.

Forward/Back — The screen display is similar

Sample disc-sector contents output by Disc Patcher routine.

000	01A5	27C5	07D0	18F5	*.11.P.Z*	000
008	2E4A	4A4A	4A07	00B5	*.JJJJ.L*	000
016	3FA9	5C85	3E18	ADFE	*.N.N.N.N*	010
024	086D	FF08	BDFE	08AE	*.M.L.L.L*	004
032	FF08	3015	BD4D	08B5	*.L.O=L.L*	032
040	3DCC	FF08	ADFE	08B5	*.N.L.L.L*	040
048	27CE	FE08	A62B	6C3E	*.N.L.L.L*	048
056	00EE	FE08	EEFE	0820	*.N.L.L.L*	056
064	89FE	2093	FE20	2FFB	*.L.L.L.L*	064
072	A62B	6CFD	0800	0D0B	*.L.L.L.L*	072
080	0907	0503	010E	0C0A	*.L.L.L.L*	080
088	0806	0402	0F00	2064	*.L.L.L.L*	088
096	A7B0	08A9	00AB	8D5D	*.O.L.L.L*	096
104	B691	40AD	C5B5	4CD2	*.L.L.L.L*	104
112	A6AD	5DB6	F008	EED0	*.L.L.L.L*	112
120	13D0	03EE	BCD5	A900	*.P.L.L.L*	120
128	BD5D	B64C	46A5	BD8C	*.L.L.L.L*	128
136	B520	ABA6	20EA	A24C	*.L.L.L.L*	136
144	7DA2	A013	B142	D014	*.L.L.L.L*	144
152	C8C0	17D0	F7A0	19B1	*.L.L.L.L*	152
160	A299	A4B5	C8C0	1DD0	*.L.L.L.L*	160
168	F64C	BCA6	A2FF	8E5D	*.L.L.L.L*	168
176	B6D0	F600	0000	0000	*.L.L.L.L*	176
184	0000	0000	0000	0000	*.L.L.L.L*	184
192	0000	0000	0000	0000	*.L.L.L.L*	192
200	0000	0000	0000	0000	*.L.L.L.L*	200
208	2058	FEA9	C220	EDFD	*.L.L.L.L*	208
216	A901	20DA	FDA9	AD20	*.L.L.L.L*	216
224	EDFD	A900	20DA	FD60	*.L.L.L.L*	224
232	0000	0000	0000	0000	*.L.L.L.L*	232
240	0000	0000	0000	0000	*.L.L.L.L*	240
248	0000	0000	0000	B609	*.L.L.L.L*	248
TRACK 0 SECTOR 0						

to the print layout shown, but only half as deep, so it is divided into two screens, offset 0 to 127 and offset 128 to 255. You can flip from one to the other using these options. **Change** — This option allows you to change an area within the sector buffer to a hex string which you are asked to key in. You must enter the start offset where the overlay is to begin, and the program will display up to 15 bytes in hex currently at that location. You are then prompted to enter the overlay

value as a hex string. The value you enter must have an even number of valid hex characters, and you cannot key any more characters than the number displayed. The main display is refreshed, showing the sector as it looks with your changes applied. The process can be repeated until you are happy with the result, when you can request that the sector be written back via the main menu. **Exit** — Ends the program.

5MB WINCHESTER FOR APPLE II

- LOWEST COST/MBYTE FROM ANY SUPPLIER
- SINGLE APPLE CONTROLLER
- PASCAL COMPATIBLE "DROP IN" BIOS
- LICENSABLE "PROTECTED SOFTWARE" OPERATING SYSTEM (only available to bona-fide software suppliers)
- DEDICATED APPLE II
- FAST DELIVERY

SUBSYSTEM DOES NOT INCLUDE APPLE DRIVE



SYMBFILE

LOWEST UK PRICES

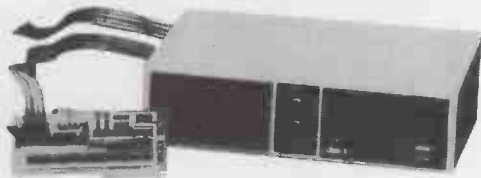

apple computer
Sales and Service

R.R.P. **£1450**

TO PLACE YOUR ORDER, OR TO MAKE
FURTHER ENQUIRIES, CONTACT:-

**symbiotic
computer systems**

85/87 STATION ROAD, WEST CROYDON,
SURREY CR0 2RD

01-680 8606

● Circle No. 181

PROFESSIONAL SOFTWARE

CP/M — CDOS — CROMIX INTEGRATED COBOL PACKAGES

- ★ *Accounts*
- ★ *Invoicing*
- ★ *Wages*
- ★ *Stock*
- ★ *Word Processing*
- ★ *Data Base Systems*

Complete Business Systems for Retail & Wholesale trades, Manufacturing and Service industries + many more.

Services include implementation, support, programming and free helpful advice on equipment. Source code available if required.

Tolimit LTD
GENERAL COMPUTER SERVICES

Tel. Fakenham (0328) 710810.

BURNT STREET, WELLS-NEXT-THE-SEA, NORFOLK.

● Circle No. 285

APPLE II

and

ITT2020 PAYROLL

£30.43 + VAT

A program with many outstanding features in spite of its low price!
Example: If you enter net pay — the program will compute gross pay deductions!

ZX Spectrum Software

now available, please phone Payroll, Stock Control, etc.

Tel: 01-485 1059

HILDERBAY LTD
8-10 PARKWAY, REGENTS PARK
LONDON NW1 7AA

● Circle No. 287

• Limited Dealerships Available

STOP!
This is NOT the Empress
Word Processing System



EXPRESS

ACCOUNTING SYSTEM

- ★ Separate keyboard with 14 special function keys for fast processing ★
- ★ High speed 132 column dot matrix printer ★
- ★ 'BUSY 1' powerful accounts package ★
 - ★ Customised work station ★
 - ★ British made micro computer ★
 - ★ Green screen — less eyestrain ★



EMPIRE

Computer Systems Ltd
40 Triton Square
London NW1 3HG
01-387 4599

NAME	
POSITION	
COMPANY	
ADDRESS	
PHONE	

Any four colours can be selected at a time from the palette of 255 available.

Automatic character magnification.

User-defined shading patterns.

Fast block fill facilities provided.

Text in 40 character mode with 80 character mode overlaid.

Characters can be oriented in any of four directions.

'Windows' can be defined and scrolled independently.

A picture may be worth a thousand words but it still tells only half the story about graphics on the 380Z.

For a start, our standard graphics functions include point plotting, line drawing, instant block fill, block copying, offsetting, and Exclusive Or Plotting.

Then there is the important fact that our Level 2 High Resolution Graphics is supported by Basic, Algol, and Fortran. And since it is contained in an additional 16K of RAM, every byte of user memory remains available for applications programs.

It is also worth noting that 380Z graphics are equally effective in monochrome — for 'colour' just read 'shades of grey'. Again there are 255 shades available, and there's also a very useful facility for fading up and down throughout the grey scale.

There are also the special effects — such as moving between graphics 'pages' for pseudo-animation, or the

ability to produce 'instant' graphics by drawing them with the colour 'switched' off and then 'switching' on.

Next, not only can 380Z graphics pictures be saved on and retrieved from disc, they can also be output to one of a range of popular dot matrix printers.

Remember, too, that HRG is not a third-party add-on but designed, developed, and supported by Research Machines itself as an integral part of the 380Z.

And finally, we've now implemented GINO. So for the first time this well-established, professional suite of flexible, device-independent graphics software from the CAD Centre is available on a micro.

If you are interested in graphics — for scientific, technical, and industrial research; or in secondary or higher education; or for design, engineering, or control, then you will be interested in the 380Z.

GRAPHICS MACHINE



RESEARCH MACHINES
MICROCOMPUTER SYSTEMS

RESEARCH MACHINES LTD Mill Street, Oxford OX2 0BW, Tel: (0865) 49866



Command exchange

THIS MACHINE-CODE routine for the ZX-81 by Michael Wood of Exmouth, Devon goes through any program contained within the RAM byte by byte and changes one command for another. In this example it changes all Print statements to LPrint statements. A feature of this routine is the ability for it to stop part way through a program. To achieve this you simply place a Stop statement in the program where you want it to stop.

To place the routine above RAMtop on the 1K machine:

- Poke 16388, 236.
- Poke 16389, 67.
- Execute New.
- Using program 1, enter each hexadecimal number separately.
- Execute New once again.

If you have a 16K RAM, change the first two steps to

- Poke 16388, 237.
- Poke 16389, 127.

You are now ready to test the routine.

Enter: 10 PRINT

followed by RAND USR 17388

The routine is at 32749 if you have a 16K

Command exchange — program 1.

1K version.

```
10 FOR I=17388 TO 17406
20 INPUT A
30 POKE I,A
40 NEXT I
```

16K version.

```
10 FOR I=32749 TO 32767
20 INPUT A
30 POKE I,A
40 NEXT I
```

Machine code.

Decimal	Z80 Assembler
33 128 64	: ld hl,16513
35	: inc hl
126	: ld a,(hl)
254 227	: cp 227 ("STOP")
200	: ret z
126	: ld a,(hl)
254 245	: cp 245 ("PRINT")
194 *239* *67*	: jp nz 17391
54 225	: ld (hl),225 ("LPRINT")
195 *239* *67*	: jp 17391

-- if you have the 16k rampack change these to :

239 becomes 240
67 becomes 127

RAM. After Newline you should immediately see 0/0. List the program, and you should see:

```
10 LPRINT
```

If you want to change some other characters, just Poke the code of the character you wish to change to 17398 — or to 32759 if you have 16K RAM. Then Poke the code of the character you want to change to 17403 — 32764 if you have 16K RAM.

Physics routines

THIS PROGRAM by I J Moore of Nottingham provides a choice of standard physics calculations.

When you input variables, time should be in seconds, mass should be in kilograms, height, radius and distance moved should be in metres, and the force and heat supplied should be in joules.

The following variables are used:

A, B, C - the figures which are to be used in the following calculations; they match with A\$, B\$ and C\$ respectively.

D - the option which is chosen.

Z - the answer which is obtained from the calculation.

A\$, B\$, - the names of the items which are to be input.

Y\$ - the unit of the item being calculated.

Z\$ - the item being calculated.

The program is divided into the following sections:

1-22 print out the options which are available.

23-25 input the option required by the user.

30-495 set up the variables in accordance to the option chosen.

1000-1170 input the figures which are to be used in the calculations.

1180-1280 execute the appropriate calculations.

1290-1300 print out the answer with its unit.

1310-1360 input the user's decision as to, the continuation of the program.

1370-1390 go to the relevant part of the program.

Physics routines.

```
1 REM PHYSICS CALCULATIONS
2 REM BY IAN MOORE
3 CLS
4 PRINT TAB 6;"OPTIONS AVAILABLE"
5 PRINT TAB 6;"-----"
6 PRINT "1. VOLTAGE IN A CIRCUIT"
7 PRINT "2. CURRENT IN A CIRCUIT"
8 PRINT "3. CHARGE IN A CIRCUIT"
9 PRINT "4. RESISTANCE IN A CIRCUIT"
10 PRINT "5. POWER IN A CIRCUIT"
11 PRINT "6. KINETIC ENERGY"
12 PRINT "7. POTENTIAL ENERGY"
13 PRINT "8. CENTRIPETAL FORCE"
14 PRINT "9. FORCE ON A MOVING OBJECT"
15 PRINT "10. WORK DONE"
16 PRINT "11. PRESURE ON AN AREA"
17 PRINT "12. DENSITY OF A SUBSTANCE"
18 PRINT "13. SPECIFIC HEAT CAPACITY"
19 PRINT "14. VELOCITY OF WAVES"
20 PRINT "15. IMPULSE DURING A COLLISION"
21 PRINT "16. MOMENTUM OF AN OBJECT"
22 PRINT
23 PRINT "PLEASE INPUT YOUR OPTION ";
24 INPUT D
25 PRINT D
26 GOTO D*30
30 LET A$="CURRENT"
35 LET B$="RESISTANCE"
40 LET Z$="VOLTAGE"
45 LET Y$="V"
50 GOTO 1000
60 LET A$="VOLTAGE"
65 LET B$="RESISTANCE"
70 LET Z$="CURRENT"
75 LET Y$="A"
80 GOTO 1000
90 LET A$="CURRENT"
95 LET B$="TIME"
100 LET Z$="CHARGE"
105 LET Y$="C"
110 GOTO 1000
120 LET A$="VOLTAGE"
125 LET B$="CURRENT"
130 LET Z$="RESISTANCE"
135 LET Y$="-O- (OHMS)"
140 GOTO 1000
150 LET A$="VOLTAGE"
155 LET B$="CURRENT"
160 LET Z$="POWER"
165 LET Y$="W"
170 GOTO 1000
180 LET A$="MASS"
185 LET B$="VELOCITY"
190 LET Z$="KINETIC ENERGY"
195 LET Y$="J"
200 GOTO 1000
210 LET A$="MASS"
215 LET B$="HEIGHT"
220 LET Z$="POTENTIAL ENERGY"
225 LET Y$="J"
230 GOTO 1000
240 LET A$="MASS"
245 LET B$="VELOCITY"
250 LET C$="RADIUS"
255 LET Z$="CENTRIPETAL FORCE"
260 LET Y$="N"
265 GOTO 1000
270 LET A$="MASS"
275 LET B$="ACCELERATION"
280 LET Z$="FORCE"
285 LET Y$="N"
290 GOTO 1000
300 LET A$="FORCE"
305 LET B$="DISTANCE MOVED"
310 LET Z$="WORK DONE"
315 LET Y$="J"
320 GOTO 1000
```

(continued on next page)

Income tax

THIS TAX-ASSESSMENT PROGRAM by D A Pryce of Nottingham runs on 1K ZX-81s and is based on tax rates set by the March 1982 Budget. It can cope with:

- Standard or higher rate taxpayers.
- Married or single tax status.
- Joint assessments.
- Mortgage interest relief.

It should prove useful to taxpayers, accountants and even tax collectors.

When you run the program it will ask you if you are married, single or require a joint assessment, type M, S or J and press Newline. Enter your annual mortgage interest payment if you are entitled to this relief, otherwise type O and Newline.

The program then prints out your annual salary, national insurance, tax and net pay for the year. The following variables are used:

- M\$ - marital status
- S - salary for tax purposes
- I - annual mortgage interest payments
- A - personal allowance
- N - national insurance
- T - taxable income
- X - tax payable
- G - net pay receivable

Hexad

HEXAD by Paul Morriss of Alford, Lincolnshire enables you to assemble and disassemble hex from and to Rem statements and will also allow full editing facilities. Either of the two sections can be entered when needed or both at once.

The program as it stands will assemble and disassemble into a Rem statement which is the first line of the program. If you want to do this then type 10 Rem and enough characters to hold the machine code. If you want to place it above RAM-top then replace lines 1000 and 2000 with

```
LET Y=16514
```

and lines 1010 and 2010 with

For X=address of first byte for machine code to address of last byte. Make sure these figures are accurate or you will overwrite the Basic.

To assemble the hex, place it in Rem statements like

```
20 REM 2A 0C 40.
```

The hex digits may be placed together or with any number of spaces in between. Remarks can be put in provided they start and finish with a *. Any number of Rem statements may hold the hex.

After typing in the hex it can be fully checked. To assemble the hex type Run. The program is best run in Fast mode as there is no display. At this speed it will assemble 30 bytes per second. The lines of hex may now be deleted.

Try the example program after entering the assembly program. After assembling it type

```
RAND USR 16514
```

To disassemble the machine code place some Rem statements at the beginning of the program, except for the first line if you are using it to hold the machine code. These Rem statements should contain three times as many characters as the

(continued from previous page)

```

330 LET A$="FORCE"
335 LET B$="AREA"
340 LET Z$="PRESSURE"
345 LET Y$="N/M**2"
350 GOTO 1000
360 LET A$="MASS"
365 LET B$="VOLUME"
370 LET Z$="DENSITY"
375 LET Y$="KG/M**3"
380 GOTO 1000
390 LET A$="MASS"
395 LET B$="TEMPERATURE CHANGE"
400 LET C$="HEAT SUPPLIED"
405 LET Z$="SPECIFIC HEAT CAPACITY"
410 LET Y$="J/KG K"
415 GOTO 1000
420 LET A$="FREQUENCY"
425 LET B$="WAVELENGTH"
430 LET Z$="VELOCITY"
435 LET Y$="M/S"
440 GOTO 1000
450 LET A$="FORCE"
455 LET B$="TIME"
460 LET Z$="IMPULSE"
465 LET Y$="N"
470 GOTO 1000
480 LET A$="MASS"
485 LET B$="VELOCITY"
490 LET Z$="MOMENTUM"
495 LET Y$="KG M/S"
1000 CLS
1010 PRINT "OPTION ";D
1020 PRINT "-----"
1030 PRINT
1040 PRINT A$; " :- ";
1050 INPUT A
1060 PRINT A
1070 PRINT
1080 PRINT B$; " :- ";
1090 INPUT B
1100 PRINT B
1110 PRINT
1120 IF D<>B AND D<>13 THEN GOTO 1170
1130 PRINT C$; " :- ";
1140 INPUT C
1150 PRINT C
1160 PRINT
1170 PRINT
1180 IF D=2 OR D=4 OR D=11 OR D=12
    THEN GOTO 1240
1190 IF D=6 OR D=8 THEN GOTO 1260
1200 LET Z=A*B
1210 IF D=13 THEN LET Z=C/Z
1220 IF D=7 THEN LET Z=Z*9.81
1230 GOTO 1290
1240 LET Z=A/B
1250 GOTO 1290
1260 LET Z=A*(B**2)
1270 IF D=6 THEN LET Z=Z/2
1280 IF D=8 THEN LET Z=Z/C
1290 PRINT Z$; " :- ";Z; " ";Y$
1300 PRINT
1310 PRINT "DO YOU WANT :- "
1320 PRINT
1330 PRINT "1. THE SAME OPTION"
1340 PRINT "2. A DIFFERENT OPTION"
1350 PRINT "3. THE END"
1360 INPUT L
1370 IF L=1 THEN GOTO 1000
1380 IF L=2 THEN GOTO 3
1390 STOP

```

Income tax.

```

5 PRINT "MARITAL STATUS M,S,O,R,J ?"
10 INPUT M$
15 PRINT "SALARY?"
20 INPUT S
25 PRINT "MORTGAGE INTEREST?"
30 INPUT I
35 CLS
40 LET A=(1565 AND M$="S") + (2445 AND M$="M") + (4010 AND
M$="J")
50 LET N=(.0875*S AND (S>1534)) - (.0875*(S-11440) AND
(S>11440))
60 LET T=S-A-I
70 LET X=(T*.3 AND T>0) + ((T-12800) *.1 AND T>12800) + ((T-
15100) *.05 AND T>15100) + ((T-19100) *.05 AND T>19100) + ((T-
25300) *.05 AND T>25300) + ((T-31500) *.05 AND T>31500)
80 LET G=S-X-N
84 PRINT TAB 10;"#"
85 PRINT "SALARY ",
90 PRINT S
95 PRINT "NI ",
100 PRINT N
105 PRINT "TAX ",
110 PRINT X
115 PRINT "NET PAY ",
120 PRINT G

```

number of bytes of machine code. If the machine code is 10 bytes long then type in:

```
20 REM .....
```

or

```
20 REM .....
```

```
30 REM .....
```

When you run the disassembly program with Run 2000 it will place the hex of the machine code into these statements with a space between each pair of digits. Now the Rems can be brought down with Edit, and more hex can be added or any deleted. Reassemble the hex by typing Run.

This offers comprehensive editing as with Basic statements. If you want no spaces to be put in between the hex digits then omit line 2050 and change line 2060 to

```
LET Y=Y+3.
```

When using the disassembly program make sure there is no line numbered 118, or this will cause a crash.

The program fits in 1K, but it is best suited to 16K users.

Hexad.

Example program.

```

10 REM .....
20 REM 2134 40 CB46 2B05
30 REM *BLACK* 3E80 D7 1BF4 *RESTART*
40 REM *WHITE* AF D7 1BF0 *END*

```

Assembly program.

```

1000 LET Y=16518+PEEK 16511+256*PEEK
1010 FOR X=16514 TO Y-7 16512
1020 IF PEEK Y=11B THEN LET Y=Y+6
1030 IF PEEK Y=23 THEN GOTO 1090
1040 IF PEEK Y=0 THEN GOTO 1110
1050 POKE X,16*PEEK Y+PEEK (Y+1)-476
1060 LET Y=Y+2
1070 NEXT X
1080 STOP
1090 LET Y=Y+1
1100 IF PEEK Y<>23 THEN GOTO 1090
1110 LET Y=Y+1
1120 GOTO 1020

```

Disassembly program.

```

2000 LET Y=16518+PEEK 16511+256*PEEK
16512
2010 FOR X=16514 TO Y-7
2020 LET Y=Y+6*(PEEK Y=11B)+7*(PEEK
(Y+1)=11B)+8*(PEEK (Y+2)=11B)
2030 POKE Y,INT(PEEK X/16)
2040 POKE Y+1,PEEK X-INT(PEEK X/16)*16
2050 POKE Y+2,0
2060 LET Y=Y+3
2070 NEXT X
2080 STOP

```



Plakoto

THIS PROGRAM written by Peter Lawson for the Acorn Atom, is a follow-up to the article on Backgammon in the May 1981 issue of *Practical Computing*. Plakoto is a somewhat simpler version of the game played in Greece. The main difference is

that in Plakoto all the pieces start from the farthest points. If a blot is hit, the opponent's piece is not sent to the bar but merely trapped until the trapping piece is moved away. Until this happens the point belongs to the trapper.

These slight differences simplify both illegal-move checking and the move-evaluation algorithm and make the game suitable for practising evaluation techniques. The evaluation routines are laid out here in decipherable form in sub-routines m, o and p to give you the opportunity of rewriting this section of the program to make the computer harder to beat. Lines 701 to 707 and subroutine v are included for use in the design stage only. A printer is also needed.

Having established a preliminary algorithm, you play a game against the computer. After each of the computer's moves you are invited to view the move which has just been made. If you are dissatisfied with the computer's move,

this option is exercised by entering Y, whereupon the available moves and the values placed on them are printed out, followed by a record of the board position after the move was made. At the end of the game you can study all the offending moves and adjust the algorithm accordingly.

After removing all the Rem statements, the program will run in the lower text space of an expanded Atom 4.75K. To save space extensive use has been made of abbreviations:

F. For
N. Next
G. Goto
E. End
S. Step
P. Print
GOS. Gosub
A. Absolute
R. Return or random
U. Until
Ll. Link
? = Peek or Poke
(continued on next page)

Plakoto.

```

100 REM Plakoto
130 DIM A$25, B$25, H$25, T$25, Y11, Y11, Y11, Z4
140 S=#8880;V=#21C;G=24;H=1;C=0;W=2;K=0
150 F,J=#0T025;B$J=0;T$J=0;N.
159 REM Start men
160 B$1=-15;B$24=15
169 REM Display board
170 P.#12;?#E1=0;@=2;F,J=1T012;P.13-J
180 I=0;DOP.#9;I=I+1;U.I=28;P.12+J;N.
189 REM First roll
190 GOS.a
200 O GOS.h;U.M=2;P."I THREW"Z71;YOU THREW"Z72
210 IF Z71>Z72 P." I BEGIN";A=1;Ll.#FB7D;G.500
220 P."YOU BEGIN";A=-1;GOS.i
239 REM Human's move
300 P."YOUR GO WITH"Z71;"Z72";F=0;IF W=2 Ll.#FB7D
310 L=0
320 L=L+1;GOS.w
330 GOS.s
340 IF U>0 P."NO LEGAL MOVE WITH"Z7L"-HIT KEY";Ll.#FFE3;G.600
350 P."MOVE"Z7L" FROM";IN.#V
360 IF ?V=0 GOS.x;Ll.#FB7D;G.U
370 W=VAL;IF O=0 G.330
380 O=0+Z7L;IF D>25 D=25
390 GOS.l
400 IF U>0 P." ILLEGAL MOVE TYPE"U"-HIT KEY";Ll.#FFE3;U=0;G.330
410 G.700
499 REM Atom's move
500 P."MY GO WITH"Z71;"Z72'
510 L=0
520 L=L+1;P=L*2
530 GOS.k;GOS.n;IF D<0 D=0
540 IF B<0 P." I PASS";Ll.#FB7D;G.600
550 G.700
559 REM Pass checking
600 K=K+L
610 IF M=4G.800
620 IF K=1G.(420+100*A)
630 G.800
700 GOS.r;GOS.q;GOS.J;IF W<0 GOS.t;G.900
701 IFA=-1G.710
702 ?#DE=#A0;?#DF=#B1;?#E0=25
703 IN."VIEW"#V
705 IF ?V=0 GOS.v
707 F.T=441T0447;S?T=32;N.
710 IF K=3G.800
720 IF K+L=3 K=3;G.(410+100*A)
730 IF L=M G.800
740 G.(420+100*A)
759 REM Move over
800 GOS.h;GOS.q;A=-A;K=0;G.(400+100*A)
859 REM Game over
900 IF W>0 G.930
910 P."YOU WIN "-W" UNIT";G.950
930 P."I WIN "W" UNIT"
950 IFA.W=2 P."S (GAMMON)"
960 IFA.W=3 P."S (BACKGAMMON)"
970 IN."ANOTHER GAME"#V
980 IF ?V=0 G.140
990 E.
999 REM Display men
1000 A.F.J=2T0378S.4;IF JX32=30N.
1005 S!J=#20202020;N.
1010 F.J=1T024;AAJ=0;HHJ=0
1020 IF T$J>0 GOS.u;G.1090
1030 IF B$J<0 HHJ=-BBJ
1040 IF B$J>0 AAJ=BBJ
1050 IFAJ>0 IFAJ<15 GOS.d;G.1090
1060 IF HHJ>0 IF HHJ<15 GOS.e;G.1090
1070 IFAJ=15 GOS.f;G.1090
1080 IF HHJ=15 GOS.g
1090 N.,R.
1100 IF JX13S?(386-32*J)=#44;R.
1110 S?(32*J-387)=#48;R.
1150 C IF JX13S?(386-32*J)=#C4;R.
1160 S?(32*J-387)=#C8;R.
1200 DI=0;D0I=I+1
1210 IF JX13S?385-TTJ-32*J+I=#C4;G.1230
1220 S?(32*J-I-386+TTJ)=#C8
1230 U.I=AAJ;R.
1250 E=0;D0I=I+1
1260 IF JX13 S?(385+TTJ-32*J+I)=#44;G.1280
1270 S?(32*J-I-386-TTJ)=#48
1280 U.I=HHJ;R.
1300 ?F.T=375T0381;S?T=#E2;N.;S?374=#C8;R.
1350 ?F.T=354T0360;S?T=#51;N.;S?361=#44;R.
1399 REM Dice toss
1400 H.F.J=1T02;Z7J=A.R.%6+1;N.;IF Z71=Z72 M=4;Z73=Z71;Z74=Z72;R.
1410 M=2;IF W=2R.
1420 IF Z71<Z72 GOS.l
1430 R.
1450 IZ73=Z71;Z71=Z72;Z72=Z73;R.
1499 REM Analyse game
1500 JG=0;F.J=0T024;IFAAJ>0 G=J
1502 IF B$J<0 N=J
1505 N.
1510 H=0;F.J=25T01S.-1;IF HHJ>0 H=J
1512 IF B$J<0 K=J
1515 N.
1520 C=0;IF G<H C=2
1525 IF X>G C=1
1530 W=BB25/15;IF B$0=15 W=1
1540 R.
1599 REM Array of legal moves
1600 K.F.J=0T011;Y?J=0;YYJ=0;N.;R=-1
1610 F.J=24T01S.-1;O=J;D=J-Z7L;IF D<0 D=0
1620 GOS.l;IF U>0 G.1670
1630 R=R+1;IF M=4 GOS.p
1640 IF M=2 E=100;GOS.m
1650 Y?R=E;YYR=25*O+D
1660 IFR=11;J=1
1670 N.;R.
1679 REM Find best move
1680 N1=0;B=-1;F.J=0T011;IF Y?J>I B=J;I=Y?J
1690 N.;IF B<0R.
1695 O=YYB/25;D=YYB%25;R.
1699 REM Illegal moves
1700 U=0;IF B$0 X<1 U=1;R.
1710 IF B$0 X<1 U=2;R.
1720 IF TTD=A U=3;R.
1725 IF TTD=A U=4;R.
1730 IFA=-1G.1770
1740 IF D=0 IF G>6 U=7;R.
1750 IF D<Z7L IF G>0 U=8;R.
1760 R.
1770 IF D=25 IF K<19 U=5;R.
1780 IF (25-O)>Z7L IF K<0 U=6
1790 R.
1799 REM Move evaluations

```

(listing continued on next page)

(listing continued from previous page)

```

1800M IFG<7IFD=Z7L E=10+8*TTD;R.
1810IFG<7E=0+2+6*TTD;R.
1820IFC=2E=0;R.
1830IFC=1E=25+0+25*TTD;R.
1840IFBBD>1E=E+D/4-5*8BD
1850IFBBD=1IFTTD=0IFD>H E=E+55+2*8D
1860IFBBD=0IFD>H E=E-75-D
1870IFBBD=-1E=E+95-2*8D
1880IFD<X E=E+20
1900IFD>18E=E+0; IFN<11E=E+0
1910IFBBD=1IFTTD=0IFD>H IFBBD>0E=E+25+0; IFD>18IFN>9E=E+100
1915IFBBD=1IFTTD=0IFD>18IFD-N<10E=E+25
1920IFBBD=1IFTTD=-1E=E-120+0
1925IFBBD=1IFTTD=0IFBBD=1IFTTD=0E=E+30; IFP=0E=E+20
1930IFBBD>1IFTTD=-1E=E+0/4
1940IFBBD>2E=E+0/4
1950IFBBD=2IFTTD=0IFD>X E=E-60-0; IFD>18IFN>9E=E-90
1955IFD<7E=E-100
1960IFP=1 IFD<X GOS.0
1965IFE<1E=1
1970IFE>255E=255
1975R.
1979 REM Consider following roll!
1980OF=D+Z72; IFF>24R.
1985IFBBF=-1E=E+50
1990IFBBF=1IF TTF=0E=E+40
2000IFBBF>1E=E+20
2010F=D-Z72; IFF<1R.
2015IFBBF=1IF TTF=0E=E+60
2020IFBBF>1IF TTF=-1E=E+20
2030IFBBF>2E=E+20
2040IFBBD<>2R.
2050F=D+Z72; IFF>24R.
2055IFBBF=-1E=E+50
2060IFBBF=1IF TTF=0E=E+40
2070IFBBF>1E=E+20
2080F=D-Z72; IFF<1R.
2085IFBBF>1IF TTF=-1E=E+20
2090IFBBF>2E=E+20
2100IFBBF=1IF TTF=0E=E+60
2110R.
2129 REM Double rolls

```

```

2130PE=100; IFP=0GOS.0;R.
2135IFBBD=2E=150+2*0;G.2170
2140IFBBD>2IFTTD=-1E=E+75-0;G.2150
2145IFBBD>2IFD>H E=E+75-0;G.2170
2150IFBBD>3IFD>H E=E+90-0;G.2170
2160GOS.0;R.
2170IFBBD=0IFD>H E=E+25
2175IFBBD=-1E=E+75
2180IFBBD=1IF TTD=0IFD>H E=E+50
2185IFD<H E=E+20
2190R.
2199 REM Move men
2200IFBBD=-A;TTD=-A;8BD=0
22108BD=8BD+A;8BD=8BD-A
2220IF TTD=-A;IFBBD=0 ;TTD=0;8BD=-A
2230R.
2299 REM Clear part of screen
2300SF,R=416T0511;S7R=32;N.1?#DE=4A0;?#DF=#81;?#E0=0;R.
2350AF,P=394T0511;S7R=32;N.1?#DE=#00;?#DF=#81;?#E0=0;R.
2399 REM Win margin
2400tIFW=-1IFBBD=0 W=-2;IFG>16W=-3
2410IFW=1IFBBD=0W=2;IFW>7W=3
2420R.
2499 REM Traps
2500IF TTJ<0HHJ=1;AAJ=8BJ;GOS.b;GOS.d;R.
2510AAJ=1;4HJ=-8BJ;GOS.c;GOS.e;R.
2599 REM Has human legal move?
2600WF,J=1T024;0=J;J=D=J+Z7L;IFD>25D=25
2620GOS.1;IFU=0J=24;N.;R.
2640N.;R.
2650IFL=1IFF=0F=1.P."FREE PASS";U=600;R.
2670U=330.P."ILLEGAL PASS";R.
2999 REM Record move
3000V.#21#2
3010F,J=0T011;IFY?J>0P.YYJ/25"-YYJ/25"="Y?J";R.
3020N.
3050P."BEST MOVE "YB/25"-"YB/25"
3060F,J=1T024;P.J="8BJ";IFTTJ<>0P.TTJ"TRAP";R.
3070N.
3085P."P="P",L="L",Z?1="Z?1",Z?2="Z?2"
3090P.#3#6
3100R.

```

(continued from previous page)

If more memory is required for the evaluation it could be obtained by using the free space pointer to put the arrays into the upper text space. To do this insert:

```
110 ?35 = 0; ?36 = #82
```

The following variables are used:

- A. 1 if Atom's move, -1 if human's move.
- B. Best move.
- C. Contact flag.
- D. Destination.
- E. Evaluation of move.
- F. Future move and free pass flag.
- G. Atom's back man's position.
- H. Human's back man's position.
- K. Pass counter.
- L. Dice counter.
- M. Number of moves.
- N. Human's front man's position.
- O. Origin.
- P. Odd move flag.
- U. Illegal move flag and type.
- W. 2 at start of game, later win type.
- X. Human's back free man.

The arrays are as follows:

AA Atom's men.

- BB Both men.
- HH Human's men.
- TT Traps.
- Y Legal-move byte vector.
- YY legal moves encoded.
- Z Dice toss byte vector.

The byte vectors can only hold a value between 0 and 255, so the value of E is limited in lines 1965 and 1970.

In line 140, S is set to the start of screen memory, V to an unused area in page 2. In line 170, P\$12 clears the screen and homes the cursor. ?#E1=0 turns off cursor, and (a = 2 sets numeric-field width. Line 180 moves the cursor across the screen, and line 200 rejects doubles for the first roll.

In line 210, Link #FB7D gives a two-second delay, and in line 340, Link #IFE3 waits for a key to be pressed. In line 360 G.U goes to line 2500. In line 520, P is the remainder from L/2. Line 702 moves the cursor.

Lines 1000 to 1005 clear the centre of screen, but not the margins. In line 1100, #44 and #48 are single, white pixels: in

line 1150, #C4 and #C8 are single, grey pixels; in lines 1300 to 1350, #E2 is a double grey pixel and #51 is double, white pixel. Line 3000 turns the screen off and turns the printer on, while line 3090 does the reverse.

Atom Print At

I HAVE ALWAYS been envious of the ZX-81 in that it has a Print At facility, writes John Ferguson of Chelmsford, Essex. My Atom does not have this function but I have found it possible to use a string of characters to move the cursor in the same way that cursor controls can be included in a string on a Pet.

The routine starts by setting the field width to zero, line 10, otherwise numbers in a Print statement would not be positioned at the cursor position. Line 20 dimensions the string, clears the screen and inputs the screen co-ordinates.

In line 30 a space is Poked into the top left corner of the screen to get rid of a block that would be left there and ?#E1=0

turns the cursor off. Then the two lines following check for quantities out of range and calculate the co-ordinates. Line 60 is the string of control characters: I is cursor forward, and J is cursor down.

String C in line 70 is shortened by the Atom equivalent of Mid\$, allowing for the co-ordinates.

The loop that follows prints each character as a cursor-control code by subtracting 64 so that the cursor is positioned correctly for printing "Hello": I is converted to 9, the code for horizontal Tab, and J is converted to 10 the code for Linefeed.

Atom Print At.

```

10 @=0
20 DIM C45;P.#12;IN."PRINT AT -"A,B
30 P.#12;?#8000=32;?#E1=0
40 IF A>31 IF B>15 G.10
50 A=31-A;B=31+B
60 C="IIIIIIIIIIIIIIIIIIIIIIIIIIIIIIJJJJJJJJJJJJJJ"
70 #C+B="";#C=#C+A
80 FOR Z=0 TO LENC-1
90 P.#(C?Z-64)
100 NEXT Z
110 PRINT "HELLO"
120 END

```

FREE MICRO COMPUTER SOFTWARE

(with complete hardware system price)

OCSC Bookkeeping/Financial Accounting/Incomplete Records/OCSC Payroll and Wordstar/Mailmerge or Super Calc or Datastar/Supersort I or Invoicing and Sales ledger or Stock Control.

ACT SIRIUS I from **£2395** + printer cost + VAT includes 128k system, twin disk drives, 1.2 Megabytes, screen and free software.



ADLER ALPHATRONIC

from
£2095
+ printer cost + VAT
(prices subject to change)

Includes: Alpatronic P2 with Twin Disk Drives 320, Screen & Free Software.

NEC PC8000:

from
£1826
+ printer cost + VAT



Includes: 64k system, twin disk drives 320, Screen and free software.

SUPERBRAIN

from
£1630
+ printer cost + VAT
(prices subject to change)

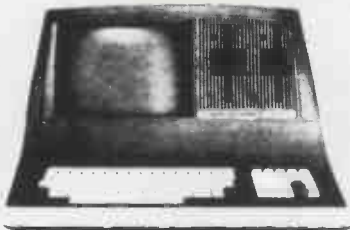

Includes: 64k system, Twin Disk Drives 320, Screen and free software.

Other software and peripherals purchased of which prices can be adjusted in the above.

We were established in 1969 as a consultancy and software house, our consultants are well qualified and members of several professional institutes.

We undertake consultancy and contract work at a very reasonable fee and our systems can be tailored to meet your requirements at a nominal fee.

Other micro manufacturers, distributors and dealer enquiries are welcomed.

Also we are looking for distributors abroad and commission agents in the U. K. Please ring for details Watford 48580.

OVERSEAS COMPUTER SYSTEMS CONSULTANTS

182a QUEENS ROAD, WATFORD, ENGLAND

CALLERS BY APPOINTMENT PLEASE

● Circle No. 185

If that Apple
is just out of Reach....

Rent One!

If you have a short term requirement for a microcomputer system for evaluation, training or just hands-on experience — come to Atlanta Data!

Apart from Apples we have top quality printers, monitors, disk drives and a huge range of software including VisiCalc, Visidex, Wordstar, Format-80, Magic Window, Micromodeller, APM, CIS COBOL and all accounting programs.

A complete system can be working for you within a few days of your enquiry with *no* capital expenditure!

Line plotters now available.

Rental Hotline 01-729 1411/2

Atlanta Data Systems

350/356 Old Street, London, EC1V 9DT. 01-739 5889

● Circle No. 186

OUT NOW! 585 IDEAS FOR YOUR COMPUTER

IDEAS
BOOK

In the Inmac ideas catalogue. See what is in this issue for you:

Cables galore! Custom-built cables, screened cables, EIA RS232C VDU extension cables and DG, DEC, TI, HP peripheral cables!

Lifetime floppies! Read about Inmac Plus—the only lifetime guaranteed floppy.

And we have 100% error-free disk cartridges and 100% flag-free disk packs for 592 different drives!

New ideas! Dozens of exciting new products and helpful hints for your computer.

Service and Quality—a promise you can rely on! We promise next-day delivery, 30 days risk-free trial, and a 12 months quality

replace-
ment
guarantee.

Free! If you use a computer.

FREE
2-year subscription.
Ring Runcorn
(09285) 67551

or send business card to
Dept. 854
Inmac (UK) Limited,
18 Goddard Road,
Astmoor Industrial
Estate, Runcorn,
Cheshire WA71QF

● Circle No. 187

5 1/4" WINCHESTER SUBSYSTEMS FROM ICE

APPLE - SUPERBRAIN - IBM PERSONAL
S100 BUS & Z80-BASED MICROS

FROM 3 TO 42 MEGABYTE CONFIGURATIONS WITH TAPE STREAMER BACKUP



ICE 15/18 Littleton Road, Ashford, Middlesex, TW15 1UQ
Telephone: 07842-47271/47171 Telex: 8952042 (DPCUSTG)

● Circle No. 189

We've opened up the whole country.

**MASS
MICROS**

- WE SUPPLY NATIONWIDE
- WE INSTALL NATIONWIDE
- MAINTAINED NATIONWIDE
- BEST PRICES NATIONWIDE
- LEASING SCHEMES

Our unique service allows you to buy anywhere in the UK with the confidence and knowledge that the equipment we supply is at the right price and supported.
Our experience of putting together the correct system for you ensures full satisfaction.

- * COMPLETE RANGE OF SOFTWARE, PRINTERS AND PERIPHERALS
- * 12 MONTHS NEXT DAY SERVICE INCLUDING PARTS, LABOUR AND TRAVEL TO YOUR SITE

- ASK FOR SERVICING QUOTES ON NEW AND EXISTING EQUIPMENT

**MASS
MICROS**

**Wellson House, Brownfields,
Welwyn Garden City, Herts.
Tel: Welwyn Garden (07073) 31436/7
Telex 298641**

Please send for FREE information pack on Apple CBM Superbrain

Name

Company

Address

Tel No:

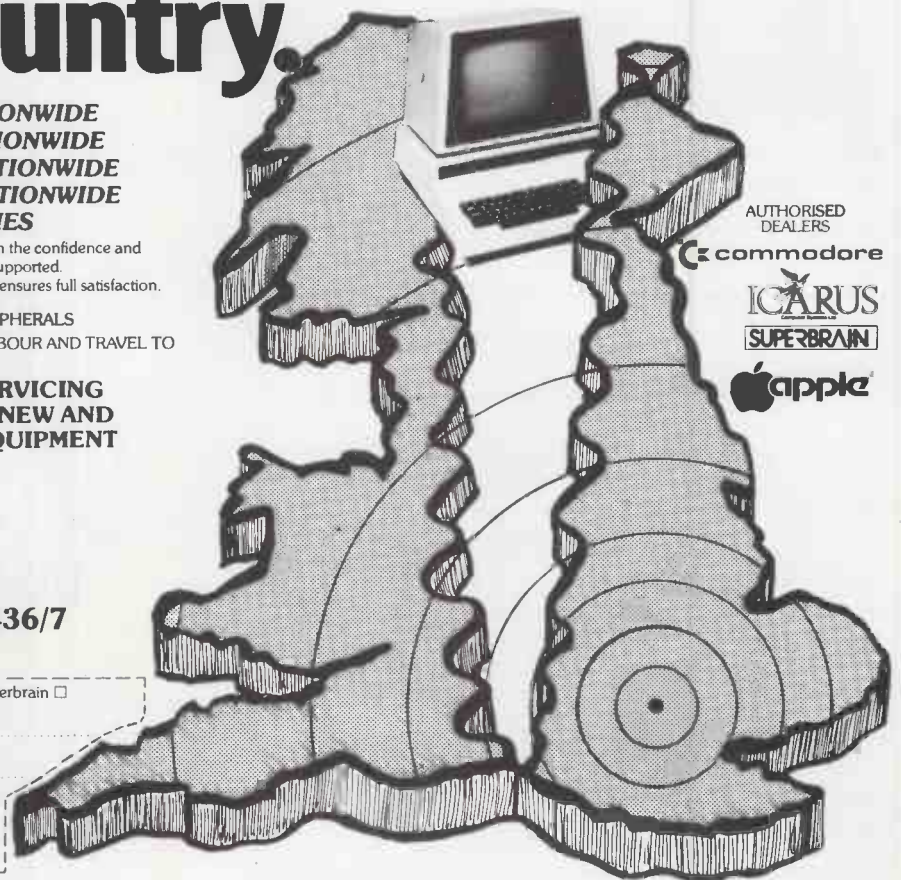

AUTHORISED
DEALERS

commodore

ICARUS
SUPERBRAIN

apple

● Circle No. 188

PRACTICAL COMPUTING August 1982

A POWERFUL MULTI-USER SYSTEM FOR £6,000.

8 BIT
and 16 BIT
processors
available

THE CLENLO ACE MULTI-USER SYSTEM.

The only genuine Micro multi-processor system readily available with the full range of multi-user facilities.

With the CLENLO ACE multi-user system up to sixteen users each have exclusive use of a Z-80A processor and 64K RAM mounted on a S-100 board, each with a serial RS-232 I/O port to which the user's VDU is attached.

The multi-user system is housed in a standard S-100 mainframe chassis enabling individual users to run programs independently and simultaneously, while still having access to shared resources (hard disc storage, printers etc.) – via the S-100 BUS Inter Processor Communication channel.

All this activity is controlled by a DPC/OS multi-user operating system running in a Service Processor and creating a complete CP/M Ver 2.2 environment for each user.

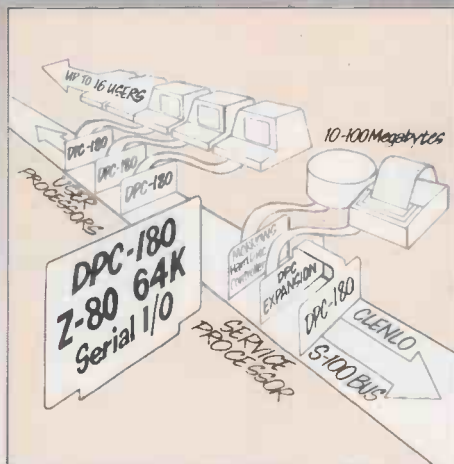

CLENLO
Microcomputers
designed for business

The CLENLO ACE multi-user system supports full multi-user facilities...

- Full lock-out at record level.
- Facility to designate files – private, group or public.
- Full 4MHz speed for each user.
- Fast memory to memory data transfer.
- Enhanced batch submit facility.
- Floppy disc storage, or Winchester hard disc storage up to 100 Megabytes.

- Automatic print spooling and de-spooling.
- Tape back-up facilities available... backed up by the exceptional CLENLO service and highly competitive prices.

Whether you want a basic two user system incorporating floppy disc storage or the facility of a full sixteen user hard disc based system with high performance, CLENLO can provide the system you need.

For more details of the best, lowest cost multi-user system on the market and our complete range of Microcomputer and business services contact CLENLO COMPUTING SYSTEMS, Telephone 01-670 4202/3.

To: CLENLO COMPUTING SYSTEMS LIMITED,
Crown House, 18 Gypsy Hill, London SE19 1NL.
Telephone: 01-670 4202/3.

- Please send me details of your ACE MULTI-USER SYSTEM.
- Please send me details of the complete CLENLO range.

Name _____

Position _____

Company _____

Address _____

Telephone _____

WHATEVER YOU WANT TO PUT IN YOU'LL GET MUCH MORE OUT OF US



XEROX 820



APPLE COMPUTER



NEC

SIRIUS 1

One plain fact you can bank on is our determination to provide the highest quality lowest cost individually applied micro-computer equipment and materials. That adds up to the finest value in London and the South — with over attentive service to match.

- * Lease and leasepurchase business plans from as little as £8.40 per week.
 - * Tailor made "in house written" programmes for specialised applications.
 - * System explanation and training that's down to earth.
 - * We'll meet and beat any price on consumable items, discs, paper, ribbons etc.
- It's as simple as that. Find out how a micro-computer can help your business.

A telephone call — 01 661 0095 — will bring us to you or visit our showrooms in Sutton.

A ONE
COMPUTERS

We give a little extra output.

56a Grove Road, Sutton, Surrey, SM1 1BT.

● Circle No. 192

FOR APPLE USERS, THE WAIT IS OVER!!!

Question: What's faster than a Winchester, and cheaper than a floppy Disc drive?

Answer: A 128K Disk emulator card.

If your software crawls along because it accesses the disk drives frequently, a disk emulator will speed your system enormously. The Disk Emulator consists of 128K of bank-switched RAM plus software to fool DOS into believing that the card is a disk. Once the software is installed, the card behaves exactly like a disk, except that it operates like lightning. Random access to data files appears instantaneous. Programs are LOADED and SAVED in far less time than with a floppy. The software provides new commands to load from a floppy onto the Disk Emulator, and from the Disk Emulator to a floppy for backup. Instructions are provided to enable the creation of turnkey systems utilising Disk Emulator cards.

The Disk Emulator is fully compatible with all software which uses the DOS 3.3 commands. It will not function correctly with programs that bypass DOS.

PASCAL and CP/M disk emulation is also supported. The Pascal implementation follows the protocol defined in Apple's ATTACH BIOS specification.

VC-PLUS is a software package included in the 128KDE system which allows VisiCalc to use memory on one of the 128KDE cards to give 82K for the VisiCalc model. If two 128KDE cards are installed, 145K becomes available.

Up to four 128K cards may be installed, giving an incredible 512K of instant-access disk space!!!

The cost of a 128K DOS 3.3 Disk Emulator system and VC-PLUS software is less than the price of a floppy drive and controller. Pascal and CP/M emulation software are low-cost optional extras.

Please contact us for further details.

Special printer offers for this month:

EPSON MX80 FT/2 printer

QUME Sprint 9/35

Silentype and interface

Stylfont daisywheel and interface

only £345 + VAT

only £1250 + VAT

only £165 + VAT

only £425 + VAT

BROMLEY COMPUTER SHOP 01-460 2580
49 BECKENHAM LANE 01-464 0541
SHORTLANDS, BROMLEY, KENT BR1 0DA



● Circle No. 191

Mailing Floppy Disks?

Use Swan Disk Mailers — and get
Safety in the Mail

Now used by over 1,000 computer companies,
Swan Disk Mailers provide outstanding postal
security at economical prices.

Combining great strength with simplicity of use,
Swan Disk Mailers are manufactured from rigid white
corrugated, holding up to four disks.

There are two sizes available: 8.75" X 8.75" & 6" X 6"



ring

01-607 9938
for Free samples
and prices

● Circle No. 193

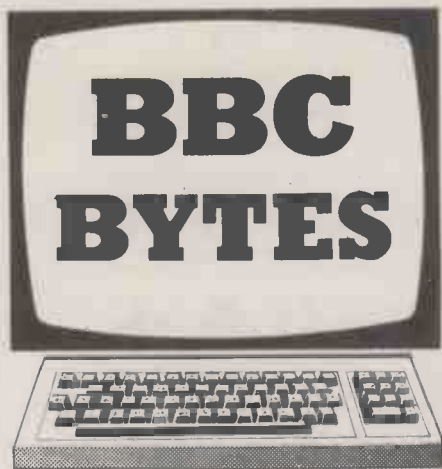

Multicoloured text

READING the provisional handbook, it appears that coloured text is only possible on the BBC Micro in modes 0-6, writes Sean Phillips of Huddersfield, West Yorkshire. Yet a full screen of text is difficult to read because of the size of the text screen. The following command, which does not appear in the provisional handbook, allows access to seven different text colours in Teletext mode, Mode 7:
 PRINT: CHR\$(&9X); "THIS WILL APPEAR IN COLOUR X"

Where X defines the colours:

- 1 = Red
- 2 = Green
- 3 = Yellow
- 4 = Blue
- 5 = Purple
- 6 = Turquoise
- 7 = White

Only the current line is affected, so each line could be a different colour if you really felt it necessary. One problem is that teletext characters are different from standard ASCII characters; try using lower case or punctuation, for example, and you will be presented with some very odd characters indeed.

Lack of lower case and punctuation is an acceptable limitation when writing program instructions. You can write the main text in white with lower case and punctuation available — and use coloured capitals for important points, for example, "Do not" messages in red, and instructions to the user in green.

Music function

THE TONE GENERATORS in the BBC Micro are capable of producing a wide range of notes, from A below middle-C to some high-pitched squeaks, notes K Penton of Reading, Berkshire. Yet it is a bit of a bind to have to set the pitch by numbers, especially as the successive notes of the major scale do not follow in regular increments.

This function converts note names, input as strings, to the required numeric form, allowing you to forget about the numbers involved and concentrate on getting the notes right. The note-name

Music functions.

```

90 REM b # b # b # b # b # b # b # b # b # b # b # b # b # b # b # b #
100 REM # Musical Notation Conversion Function #
110 REM b For BBC Computer Sound Generators b
120 REM # #
130 REM b (c) 1982 K.Penton b
140 REM b # b # b # b # b # b # b # b # b # b #
150
160 REM initialise note-name strings
170 Note$="A,A#B,C,C#D,D#E,F,F#G,G#,BbCbB#Db,,EbFbE#Gb,,Ab"
180 N2$="A.A#B.Bb"
190 GOTO 500 : REM skip function definition
200 REM N$ will be required pitch as note-name + octave, e9 A3 , C#2, Eb4
210 DEF FNM(N$)
220 IF LEN(N$)<2 OR LEN(N$)>3 THEN 320
230 N1$=LEFT$(N$,LEN(N$)-1) : OCT=VAL(RIGHT$(N$,1))
240 IF OCT<0 OR (OCT=0 AND INSTR(N2$,N1$)=0) OR OCT>6 THEN 320
250 Note=INSTR(Note$,N1$)
260 Note=Note MOD 24 -1 : IF Note <0 THEN 320
270 IF INSTR(N2$,N1$)<>0 THEN OCT=OCT+1
280 PITCH=Note*2 + (OCT-1)*48
290 IF PITCH<0 OR PITCH>255 THEN 320
300 =PITCH
310 REM - - - - -
320 PRINT N$;" is not a valid note": END
330 REM - - - - -
499 REM A little tune to demonstrate:
500 REPEAT
510 READ G$,D
520 IF G$="R" THEN SOUND 1,0,0,D : GOTO 510 : REM REST
530 SOUND 1,-10,FNM(G$),D
540 SOUND 1,0,0,0 : REM TO SEPARATE EQUAL PITCHED NOTES
550 UNTIL FALSE
1000 DATA C3,3,B2,3,C3,6,C2,6,C2,6,G2,3,F2,3,E2,3,G2,3,C3,3,B2,3,C3,6
1010 DATA D3,3,C#3,3,D3,6,D2,6,D2,6,D2,3,C2,3,B1,3,D2,3,G2,3,F#2,3,G2,6
1030 DATA A2,3,B2,3,C3,3,B2,3,A2,3,G2,3,A2,3,G2,3,F2,3,E2,3
1040 DATA F2,3,E2,3,D2,3,C2,3,C2,3,B1,3,A1,3,G1,3
1050 DATA A1,3,C2,3,B1,3,D2,3,C2,3,E2,3,D2,3,F2,3,E2,6,C2,6,C2,6
1060 DATA R,15,C2,1,E3,1,B3,1,C4,3
>
>
>*SPOOL
    
```

string must consist of two or three characters: the basic note, A-G; sharp, #, or flat — b — as required; plus its octave, 0-6. Octaves begin on C, C1 being middle-C.

The function works by finding the position of the note name in Note\$, which contains the valid names with commas to pad out the natural notes to two characters. The second 12 names are alternatives for the first 12, and line 260 adjusts for this to produce an even number between 0 and 22 for a valid note; this is doubled in line 280 to produce one of 12 increments of four in the pitch variable.

Hyperbolic calculations.

```

10 REM *** HYPERBOLIC FUNCTIONS ***
20 MODE 6:VDU 19,0,4;
30 *KEY 0 PROCsinh M
40 *KEY 1 PROCcosh M
50 *KEY 2 PROCtanh M
90 CLS:END
100 DEF PROCsinh
110 INPUT "x=?"x
120 PRINT "sinh ";x;" = ";(EXP(x)-
130 ENDFROC EXP(-x))/2"
200 DEF PROCcosh
210 INPUT "x=?"x
220 Y=VF08
230 PRINT TAB(14,Y-1);"cosh ";x;" =
240 ENDFROC ";(EXP(x)+EXP(-x))/2"
250 DEF PROCtanh
260 INPUT "x=?"x
270 PRINT "tanh ";x;" = ";(EXP(x)-
EXP(-x))/(EXP(x)+EXP(-x))"
280 ENDFROC
    
```

To this is added the multiple of 48 required to offset for the octave. Line 270 adjusts for A and B, which would otherwise end up an octave too low.

Validity checking is not comprehensive, but will catch the most common error — forgetting to add the octave number. C(b)0 will be rejected, although a valid note, since having the letter C in N2\$ would have caused more frequent errors; so B0 should be used instead.

This simple demonstration program could be expanded to include control of channel and volume using Data statements. As it stands, the program ends with an out of Data error message.

Hyperbolic calculations

THIS PROGRAM by Paul Eaton of Cambridge allows the hyperbolic functions sinh, cosh and tanh to be calculated at the mere touch of a button. It runs on a model A machine using 150 hex blocks of memory. The three functions are assigned to three red user keys:

- f0 — sinh x
- f1 — cosh x
- f2 — tanh x

For example, to calculate sinh 3.5, press f0 followed by 3.5 and Return.

The program demonstrates the use of key assignments in lines 30 to 50. Note

(continued on next page)

(continued from previous page)

that no inverted commas are used, unlike the example on page 17 of the User Guide, and that the colour command

VDU 19,0,4,0,0

can be shortened to

VDU 19,0,4;

Several published BBC Basic programs use Print to print a blank line, but it is much quicker to type ' as in lines 110, 120, etc. The display for the cosh routine shows a variation in which the answer is printed on the same line as the input, using the statement VPOS.

Fighter

THE OBJECT OF Fighter, by Brian Cassidy of Southport, Merseyside, is to destroy five enemy spacecraft in the shortest

possible time. The screen shows the head-up display of your fighter.

The control cross is the gunsight and the two numbers at the bottom are the distance from the target, the left digit being the x co-ordinate and the right digit the y co-ordinate. At point (0, 0) the enemy fighter is directly in your gunsights.

The enemy fighter moves around the screen trying to dodge out of your gunsight but you must out-maneuvre your enemy to destroy it. If the fighter is above your gunsight you should fly upwards to meet it. The controls are shown in the diagram — use the space bar to fire.

The program will run on a model A machine as long as you do not renumber or add additional lines or spaces.

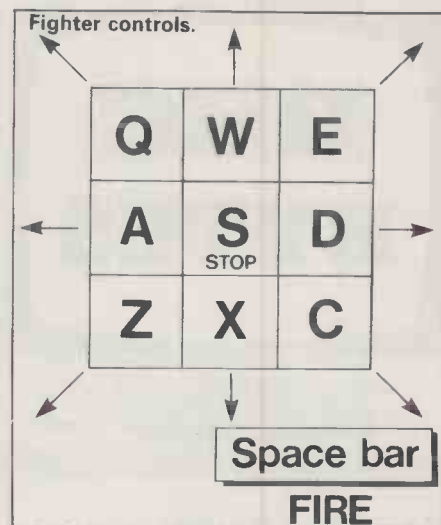

Fighter

>listLIST

```

1MODE5:VDU5,23,229,60,66,153,161,161,153,66,60,23,255,0,130,130,186,254,186,
130,130,23,225,255,255,255,255,255,255,255,255,19,1,2,0,0,0,19,3,6,0,0,0
2P=230:DIM X(8),Y(8),A(8),B(8),L$(8)
3FOR Q=1TO8:READ L$(Q),X(Q),Y(Q),A(Q),B(Q):NEXTQ:FOR NN=1TO16:FOR N=1TO8
4MOVE X(N),Y(N):GCOL0,0:PRINTL$(N):X(N)=X(N)+A(N):Y(N)=Y(N)+B(N):GCOL0,2:MOV
E X(N),Y(N):PRINT:L$(N):SOUND0,-9,RND(3)-1,2:NEXT N,NN
5FOR Q=1TO1200:NEXTQ:FOR Q=1TO10:SOUND1,-15,RND(200),1:NEXTQ:GCOL0,1:PRINTTA
B(13,4):CHR$(229):" 1982":PRINTTAB(5,25):"BY":TAB(1,27):"B. Cassidy"
6 GCOL0,1:PRINTTAB(13,4):CHR$(229):" 1982":PRINTTAB(5,25):"BY":TAB(1,27):"B.
Cassidy":FOR Q=1TO3000:NEXTQ
7DATA F,660,1224,-32,-32,I,788,660,-32,0,G,916,96,-32,32,H,544,32,0,32,T,172
,-32,32,32,E,300,404,32,0,R,428,840,32,-32,.,1063,768,0,-32
8CLS:PRINTTAB(7,2):"FLIGHT"" "DIRECTION CONTROLS":GCOL0,2:GCOL0,3:PRINTTAB(9
,7):"UP":GCOL0,2:PRINTTAB(7,9):"Q W E":GCOL0,3:PRINTTAB(2,11)"LEFT ":GCOL0,2:P
RINT"A S D ":GCOL0,3:PRINT"RIGHT":GCOL0,2:PRINTTAB(7,13):"Z X C":GCOL0,3
9PRINTTAB(8,15):"DOWN":GCOL0,3:PRINTTAB(0,20):"PRESS SPACE TO FIRE":GCOL0,1:
PRINT"YOU WILL FLY IN THE""SELECTED DIRECTION""UNTIL A NEW COURSE""IS SEL
ECTED":REPEAT:SOUND1,-10,RND(14),3:UNTILINKEY$(0)<>"
10CLS:X=RND(64)*20:Y=RND(51)*20+10:E=8:T=20:L=0:QQ=0:SC=0:TIME=0:K$="":Q$="":
U=15
11REPEAT:A=RND(8):GCOL0,1:MOVE630,512:PLOT5,590,512:MOVE650,512:PLOT5,700,512
:MOVE640,502:PLOT5,640,452:MOVE640,522:PLOT5,640,562:GCOL0,0:MOVEX,Y:PRINTCHR$(2
25)
12IFA=10RA=20RA=8 X=X-T
13IFA=20RA=30RA=4 Y=Y-T
14IFA=40RA=50RA=6 X=X+T
15IFA=60RA=70RA=8 Y=Y+T
16GCOL0,3:MOVEX,Y:PRINTCHR$(255):QQ$=Q$:Q$=INKEY$(0):*FX15,0
17IFQ$="" E=9:Q$=QQ$
18IFQ$="" Q$=QQ$
19GCOL0,0:MOVEX,Y:PRINTCHR$(225):IFQ$="A"ORQ$="Z"ORQ$="X"ORQ$="Q" X=X+T
20IFQ$="C"ORQ$="D"ORQ$="E"ORQ$="W" X=X-T
21IFQ$="Z"ORQ$="C" Y=Y+T
22IFQ$="E"ORQ$="Q" Y=Y-T
23GCOL0,3:MOVEX,Y:PRINTCHR$(255):GCOL0,0:MOVE320,64:PRINTSTRING$(3,CHR$(225))
:MOVE800,64:PRINTSTRING$(3,CHR$(225)):GCOL0,2:MOVE320,64:PRINT:(X-620)DIV20:MOVE
800,64:PRINT:(Y-530)DIV20
24IFE=9 GCOL0,2:MOVE0,0:PLOT5,640,512:PLOT5,1240,0:SOUND0,-15,4,1:K$=""
25IFE=9THENGCOL0,0:MOVE0,0:PLOT5,640,512:PLOT5,1240,0
26IFE=9THENGCOL0,0:MOVE0,0:PLOT5,640,512:PLOT5,1240,0
27GCOL0,3:MOVEX,Y:PRINTCHR$(255):IF POINT(640,512)=3 AND E=9 THEN PROCEXPL
29ENVELOPE1,2,50,100,-60,11,100,120,50,106,-100,-100,80:SOUND 1,1,255-SQR(
(X-620)^2+(Y-530)^2)DIV6,1
30E=0:UNTIL QQ=5
31*FX15,0
32PRINTTAB(0,7)"AVERAGE TIME WAS """:SC/500:" SECONDS":TAB(0,21):"ANOTHER GO?
":IFGET$="N"THEN CLS:END ELSE VDU5:GOTO10
33DEF PROCEXPL:E=8:QQ=QQ+1:SC=SC+TIME:X=640:Y=512:S=1
36REPEAT:FORQ=1TO50:SOUND0,-U,4,1:V=V+1:R=RND(S):RR=RND(S):IFV=4 U=U-1:V=0
37X=X-2:Y=Y-2:A=X+R:B=Y+RR:GCOL0,RND(3):PLOT69,A,B:S=S+4:IF S>287 THEN Q=50
38S=S+4:IF S>287 THEN Q=50
39NEXTQ:UNTIL S>287
40VDU4:PRINT TAB(0,5)"YOU BLEW IT UP IN """:TIME DIV100:" SECONDS":U=15:V=0:
FORG=1TO2000:NEXTG:X=RND(64)*20:Y=RND(51)*20+10:CLS:VDU5:TIME=0:QQ$="":*FX15,0
41ENDPROC

```



Simple animation

THIS SIMPLE animation program by David Pearson of Swinton, Manchester allows you to switch screens, or move the screen about using only simple machine-language techniques. It is centred on the amazingly useful LDIR instruction — which stands for Load Increment and Repeat. The LDIR instruction requires three parameters, HL, DE and BC which are passed over in Registers. It performs what is called a Block Move which, in essence, moves one part of memory to another. In this case the screen is moved to high memory, or vice versa.

HL points to the start of the block to be moved. DE points to the place where the block is to be moved to.

BC tells the computer how many bytes are to be moved.

Listing 1 gives an assembly language listing of a program to move 1,024 bytes — the number of bytes in a full screen — from memory location 0 to the screen. After assembling this program you will see the familiar message
MEMORY SIZE, RADIO SHACK LEVEL II BASIC

or
MEM SIZE R/S L2.

It appears because you are moving memory from the ROM, and the part you are looking at just happens to be the area with this data in it.

Listing 2 is a Basic program which uses this routine to animate a spinning globe. It is in two parts: the first creates the pictures, and dumps the screen to high memory. It takes about two minutes to run. The second part dumps the globe back on the screen, frame after frame, in rapid succession, making the globe spin.

Space orbit

THE MEAN HEIGHT of a satellite above the Earth's surface is determined by its velocity, and is in turn related to its period of revolution around the Earth, comments J Wilkinson-Latham from Paris. As the orbit shrinks due to air resistance, both the mean height and the period decrease so that the retarding effect of the air-drag actually causes the satellite to

(continued on next page)

Simple animation listing 1.

```

00100 ;*****
00110 ;****
00120 ;****
00130 ;**** ASSEMBLY LANGUAGE PROGRAMME ****
00140 ;**** TO DISPLAY THE FIRST KILOBYTE ****
00150 ;**** OF ROM... DEMONSTRATING THE ****
00160 ;**** *** LDIR *** ****
00170 ;**** INSTRUCTION ****
00180 ;*****
00190 ;
00200 ;
7F00 00210 ORG 7F00H ;CHANGE FOR 32K/48K
7F00 210000 00220 LD HL,0000H ;ADDRESS IN ROM
7F03 11003C 00230 LD DE,3C00H ;ADDRESS OF SCREEN
7F06 01FF03 00240 LD BC,3FFH ;1 K OF MEM
7F09 ED80 00250 LDIR ;DO IT !!!!
7F0B C30B7F 00260 LOOP JP LOOP ;ENDLESS LOOP
7F00 00270 END 7F00H ;CHANGE AS ABOVE
00000 TOTAL ERRORS
LOOP 7F0B
    
```

Simple animation listing 2.

```

DO NOT FORGET TO SET MEMORY SIZE TO 28600
10 REM *****
20 REM ****
30 REM **** SPINNING GLOBE ****
40 REM **** (EXAMPLE OF "LDIR") ****
50 REM **** (C), COPYRIGHT D. PEARSON ****
60 REM **** APRIL 1982 ****
70 REM ****
80 REM **** GLOBE GENERATION ****
90 REM **** PROGRAMME ****
100 REM ****
110 REM *****
120 GOSUB 370 'POKE IN ROUTINE
130 PI = 3.1416 : FOR L = 1 TO 4 : CLS
140 FOR A = 1 TO 3 : READ J
150 FOR I = 0 TO PI STEP PI/60
160 X = 63 + 40 * COS ( J ) * SIN ( I ) 'HORIZONTAL AXIS
170 Y = 23 + 20 * COS ( I ) 'VERTICAL AXIS
180 SET ( X , Y )
190 NEXT I
200 NEXT A
210 FOR A = 1 TO 3 : READ J
220 FOR I = PI TO PI * 2 STEP PI/60
230 X = 63 + 40 * COS ( J ) * SIN ( I ) 'HORIZONTAL AXIS
240 Y = 23 + 20 * COS ( I ) 'VERTICAL AXIS
250 SET ( X , Y )
260 NEXT I
270 NEXT A
280 READ B , C 'READ IN ADDRESSES
290 POKE 32754 , B 'LSB OF HIGH MEM
300 POKE 32755 , C 'MSB OF HIGH MEM
310 X =USR ( 0 ) 'CALL DUMP ROUTINE
320 NEXT L
330 GOT0560
340 REM ROUTINE TO POKE MACHINE LANGUAGE INTO
350 REM HIGH MEMORY.THIS IS THE ROUTINE TO "PUT" THE
360 REM SCREEN UP SO IT CAN BE RECALLED LATER.....
370 CLS:PRINT"POKE-ING IN DATA"
380 FOR I = 32750 TO 32761
390 READ A
400 POKE I , A
410 NEXT I
420 ' DEFUSR0= 32750 ' DISK BASIC "USR" SETUP
430 POKE16526,238 : POKE16527,127 'NORMAL LEVEL 2 USR SETUP
440 RETURN
450 REM THIS IS THE "MACHINE LANGUAGE" DATA
460 DATA 33,0,60: ' LD HL,3C00H
470 DATA 17,238,123:' LD DE,31726
480 DATA 1,255,3: ' LD BC,3FFH
490 DATA 237,176: ' LDIR
500 DATA 201: ' RET
510 REM THIS IS THE "GLOBE DRAWING" DATA
520 DATA 0,.7854,1.5708,0,.7854,0,238,123
530 DATA 0,.1963,.98174,0,.589,1.3744,238,119
540 DATA 0,.3927,1.178,0,.3927,1.178,238,115
550 DATA 0,.5890,1.3744,0,.98174,.19635,238,111
560 FORI=32750 TO 32761
570 READ A
580 POKE I , A
    
```

(listing continued on next page)

(listing continued from previous page)

```
590 NEXT I
600 DIM A(4),B(4)
610 FOR I= 1 TO 4
620 READ A(I) , B(I)
630 NEXT I
640 FOR I = 1 TO 4
650 POKE 32751 , A(I)
660 POKE 32752 , B(I)
670 X =USR ( 0 )
680 NEXT I
690 GOT0640
```

```
700 REM ROUTINE TO PUT HIGH MEM ONTO SCREEN
710 DATA 33,0,0: 'LD HL,HIGH MEM
720 DATA 17,0,60: 'LD DE,3C00H ;SCREEN
730 DATA 1,255,3: 'LD BC,3FFH
740 DATA 237,176: 'LDIR
750 DATA 201: 'RET
760 REM THIS IS THE DATA WHICH TELLS THE ROUTINE
770 REM WHERE THE SCREEN WAS PUT...
780 DATA 238,123
790 DATA 238,119
800 DATA 238,115
810 DATA 238,111
820 REM END OF PROGRAMME
830 REM *****
```

(continued from previous page)

move at a greater velocity, though in a smaller orbit.

The program, written in TRS-80 Model III disc Basic, calculates the parameters of a satellite's orbit from published data such as "Satellite X will orbit the Earth at a height of 110 miles" or "Satellite Y will orbit the Earth in 92 minutes". The computations in lines 10, 120, 190, 270 and 280 can be used as a basis for Space Invader programs.

The variables are as follows:

- H — the mean height of the orbit.
- Q — the mean height plus the Earth's mean radius, 3960 miles.
- V — the mean velocity of the satellite in miles per minute.
- T — the orbital time, in minutes.

Telephone bill

THE SHOCK of receiving a £200 telephone bill prompted this program, writes C R France of Huddersfield, West Yorkshire. Keep the computer next to the telephone with the program loaded. Press Enter whenever a telephone charge is incurred and the program will give you complete instructions.

The file for total charges is named Phone/Bas. After a week or so you could find the total telephone costs and budget for the next bill.

Space orbit.

```
10 CLS: CLEAR2000: DEFFNX(T)=INT(((H+3960)*6.2831853)/V)*100)/100
20 PRINT@340,"S P A C E O R B I T ":PRINT:GOSUB340:CLS
30 PRINT@128,"Satellites orbit at a height and speed that are in a f
ixed relationship to each other:For each height there is a spee
d and vice-versa."!PRINT
40 PRINT"it follows that for each height or speed there is an orbita
l time:The speed of the satellite slows as it gets higher":PRINT
50 PRINTTAB(10):"ACCURACY IS WITHIN + OR - 1/2 %"
60 PRINT:GOSUB340:CLS
70 PRINT@340,"1 TO OBTAIN SPEED AND TIME":PRINTTAB(20):"2 TO
OBTAIN HEIGHT AND TIME":PRINTTAB(20):"3 TO OBTAIN HEIGHT AND SP
EED"
80 PRINT:PRINTTAB(25):"WHICH ?":PRINT:GOSUB350:CLS
90 ONVAL(R$)GOTO100,170,240
100 PRINT@320,"MEAN ORBITAL HEIGHT IN MILES":INPUTH
110 PRINT"HARD COPY ? (Y OR N)":GOSUB350:IFR$="Y"GOSUB370
120 V=INT((18650/SQR(H+3960))*100)/100
130 PRINT"VELOCITY = "V" MILES PER MINUTE"
140 PRINT"ORBITAL TIME = "FNX(T)" MINUTES"
150 GOSUB380
160 GOSUB340:CLS:GOTO70
170 PRINT@320,"MEAN ORBITAL VELOCITY IN MILES PER MINUTE":INPUTV
180 PRINT"HARD COPY ? (Y OR N)":GOSUB350:IFR$="Y"GOSUB370
190 H=INT((18650/V)^2)*100)/100-3960
200 PRINT"MEAN HEIGHT OF ORBIT = "H" MILES"
210 PRINT"ORBITAL TIME = "FNX(T)" MINUTES"
220 GOSUB380
230 GOSUB340:CLS:GOTO70
240 CLS
250 PRINT"TIME OF ORBIT IN MINUTES":INPUTT
260 PRINT"HARD COPY ? (Y OR N)":GOSUB350:IFR$="Y"GOSUB370
270 Q=EXP(LOG((18650*T/6.28318)+2)/3):H=INT((Q-3960)*100)/100
280 V=INT((18650/SQR(Q))*100)/100
290 PRINT"MEAN ORBITAL VELOCITY = ";V;" MILES PER MINUTE"
300 PRINT"MEAN ORBITAL HEIGHT = ";H;" MILES"
310 GOSUB380
320 GOSUB340:CLS:GOTO70
330 GOSUB340:CLS:GOTO70
340 PRINT:PRINT"PRESS ANY KEY TO CONTINUE"
350 R$=INKEY$:IFR$=""THEN350
360 RETURN
370 CMD"Z","ON":RETURN
380 CMD"Z","OFF":RETURN
```

Telephone bill.

```
5 CLS
10 PRINT"Remember to always enter the time in DOS."
20 INPUT"Have you done that ";A$
30 IF A$="Y"THEN 40
31 IF A$="y"THEN 40 ELSE CMD"s"
40 INPUT"The distance of the call (if over 10 miles)";A
50 INPUT"Press <ENTER> when telephone is answered";B
55 PRINT"phone call charge started at ";RIGHT$(TIME$,8)
56 C$=MID$(TIME$,13,2)
57 D=VAL(C$)
60 INPUT"Press <ENTER> when conversation is finished";B
70 PRINT"Phone call charge finished at ";RIGHT$(TIME$,8)
80 C$=MID$(TIME$,13,2)
81 E=VAL(C$)
90 F=E-D
100 PRINT"Phone Call lasted for ";F;"minutes"
105 GOSUB500
110 IF A>10 THEN200
120 IF Z$="standard"THEN150
121 IF Z$="peak"THEN180
122 IFF<5THENH=.05:GOTO1000
123 IFF>5THENH=.10:GOTO1000
150 IFF<2THENH=.05:GOTO1000
151 IFF<4THENH=.10:GOTO1000
152 IFF<5THENH=.15:GOTO1000
153 IFF>5THENH=.25:GOTO1000
180 IFF<1THENH=.05:GOTO1000
181 IFF<3THENH=.10:GOTO1000
182 IFF<4THENH=.15:GOTO1000
183 IFF<5THENH=.20:GOTO1000
184 IFF>5THENH=.25:GOTO1000
200 REM
210 IF Z$="peak"THEN230
211 IF Z$="cheap"THEN250
220 IFF<1THENH=.10:GOTO1000
221 IFF<2THENH=.15:GOTO1000
222 IFF<3THENH=.20:GOTO1000
223 IFF<4THENH=.30:GOTO1000
224 IFF<5THENH=.35:GOTO1000
225 IFF>5THENH=.69:GOTO1000
230 IFF<1THENH=.10:GOTO1000
231 IFF<2THENH=.20:GOTO1000
232 IFF<3THENH=.30:GOTO1000
233 IFF<4THENH=.40:GOTO1000
234 IFF<5THENH=.49:GOTO1000
235 IFF>5THENH=.99:GOTO1000
250 IFF<2THENH=.05:GOTO1000
251 IFF<4THENH=.10:GOTO1000
252 IFF<5THENH=.15:GOTO1000
253 IFF>5THENH=.25:GOTO1000
254 GOTO1000
500 C$=MID$(TIME$,10,2)
510 P=VAL(C$)
520 IF P<8THEN550
530 IFF<9THENZ$="stan":RETURN
540 IFF<13THENZ$="peak":RETURN
550 IFF<18THENZ$="stan":RETURN
560 Z$="cheap":RETURN
1000 PRINT"Cost of that phone call is ";H
1010 OPEN"R",1,"PHONE/BAS"
1020 FIELD1,255 AS H$
1035 GET1
1040 PRINT"Total cost of telephone calls to date is ";
1050 H=H+VAL(H$) LEFT$(H$,8)
1060 PRINT"Type in total cost which is ";H
1065 CLOSE
1066 OPEN"R",1,"PHONE/BAS"
1067 FIELD1,255 AS H$
1070 INPUTY$
1071 T=VAL(Y$)
1075 IFT<>HTHENPRINT"Cheat!! Try Again!!":GOTO1070
1080 LBETH$=Y$
1090 PUT1
1100 CLOSE
1110 INPUT"Another call";G$
1120 IF G$="y"THENRUN
1130 IF G$="Y"THENRUNELSECMD"s
```

X-DATA

has the right models at the right price.

Whatever your printing needs, one of our Oki printers will fit the bill. Oki Microlines – the only complete printer range.



MICROLINE 80

- 80 column
- 80 cps
- block graphics
- pin, friction or tractor feed

**NOW
£235**



MICROLINE 83A

- Full 136 columns
- 9 x 9 matrix
- 120 cps bi-directional
- and all features of 82A

**NOW
£499**



MICROLINE 82A

- 80 column
- 9 x 9 matrix
- 120 cps bi-directional
- multiple interface capability
- pin-addressable or block graphics
- etc., etc., etc.

**NOW
£349**

MICROLINE 84

- Full 136 columns
- Mode 1 – 200 cps (400 cps skip)
- Mode 2 – near letter quality
- High-resolution graphics
- Down-line-loadable character set
- Total flexibility

**NOW
£949**

Ring Jane for your local stockist

X-Data Limited, Equipment Wholesalers.

750-751 Deal Avenue, Slough Trading Estate, Slough, SL1 4SH

Telephone: Slough.(0753) 72331; Telex: 847728

DISCOVERY SYS - GEN*

SYSTEMS AND REPORT GENERATOR
UNIQUE PROGRAMMING AND SYSTEMS AID
FOR CP/M AND CP/M86 MICRO COMPUTERS

Main components

- ★ File create
- ★ Report generator
- ★ Sort
- ★ DBMS (database management)
- ★ System generator
- ★ Select (information retrieval)
- ★ System management (utilities)

Discovery SYS - GEN will dramatically improve your productivity thus saving time and development costs.



EMPIRE COMPUTER SOFTWARE
40 Triton Square
London NW1 3HG Telephone: 01-387 4599



★Discovery SYS - GEN
a product from
Software Consultants UK Ltd

● Circle No. 196

REGISTERED REFERRAL CENTRE
FOR THE BBC PROJECT
BEEBUG FOR THE
BBC MICRO
INDEPENDENT NATIONAL USER
GROUP FOR THE BBC MICRO

IF YOU OWN A BBC MACHINE, OR HAVE ORDERED ONE, OR ARE JUST THINKING ABOUT GETTING ONE, THEN YOU NEED BEEBUG.

BEEBUG runs a regular magazine devoted exclusively to the BBC Micro (10 issues per year).

Latest news on the BBC project.

What you should know before you order a machine.

Members' discount scheme on books and hardware.

New program listings, regular advice clinic, and hints and tips pages in each issue.

April Issue: 3D Noughts and Crosses, Moon Lander, Ellipse and 3D Surface.

Plus articles on Upgrading to Model B, Making Sounds, and Operating System Calls.

May Issue: Careers, Bomber, Chords, Spiral and more. Plus articles on Graphics, Writing Games Programs and Using the Assembler.

June Issue: Mazetrap, Mini wordprocessor, Polygon; plus articles on upgrading. The user port, TV set and monitor review. Graphic Part II. More Assembler hints. Structuring in BBC Basic, plus BBC Bugs.

Membership

Introductory offer (closes 30 June)

6 months £4.50

1 year £8.50

After 30 June £4.90 and £8.90

Send £1.00 and A4 SAE for sample

(Overseas add £1.00 for 6 months, £1.50 for 1 year)

Make cheques to

BEEBUG

and send to:

BEEBUG, Dept 5,

374 Wandsworth Rd,

London, SW8 4TE

If we can satisfy the offshore oil industry - we can satisfy you

Our level of professionalism has to be that demanded by North Sea Oil companies. We offer that same level of microcomputer expertise and service to your business.

WE SPECIALISE:

In Business, Process Control, Engineering Database and communication applications.

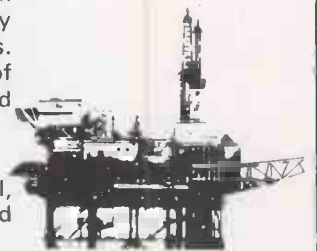

WE SELL:

Acorns, Apples, C.A.D.O. Cat, Cromemco, and now the amazing ACT SIRIUS 16 - BIT microcomputer designed by Chuck Peddle.

WE OFFER:

On-site engineering maintenance contracts for any microsystem in the Grampian Area.

WE ARE:

Sole distributors for the highly acclaimed CONDOR database management system.



GRANITE CHIPS
MICROCOMPUTERS

21 Bon Accord Street, Aberdeen.

TEL: (0224) 22520 TELEX: 739740

● Circle No. 197

● Circle No. 195

0 to 60^{ch's} in one second



THE RICOH 1600S

If it's high performance you're looking for, the Ricoh 1600S is for you, offering an amazing 60 characters in just 1 second. An updated version of the tried-and-tested 1600, the new S model has been re-designed and fitted with all sorts of extras. Yet one thing hasn't changed — the price, making the 1600S cheaper than any equivalent model on the market. This superb performer incorporates the Z80 micro-processor, auto bidirectional printing and look-ahead logic, increasing speed and efficiency. Other capabilities include proportional spacing, graph plotting and word processing enhancements. The printer includes a standard centronics interface, and RS232 and IEEE options are available.

The Ricoh 1600S is available only from Micropute and their authorised dealers, all backed up with a nationwide service network. If you're interested in the 1600S either as a customer or as a dealer, send the coupon now.

Picture shows 1600s fitted with tractor feed option

Please send me details on the Ricoh 1600S.

Name _____
 Position _____
 Company _____
 Address _____
 Tel. No _____

RICOH 1600S THE PERFORMANCE HAS RISEN — THE PRICE HASN'T

FEATURES	COMPETITORS				
	DIABLO 630	QUME SPRINT 5	SPIN-WRITER	RICOH RP.1600 (10 DATA)	RICOH RP.1600S
PRINT SPEED (CPS)	40	45/55	55	60	60
PRINT ELEMENT	DAISY-WHEEL	DAISY-WHEEL	THIMBLE	DOUBLE DAISY-WHEEL	DOUBLE DAISY-WHEEL
AUTO BIDIRECTIONAL	Yes	No	No	No	Yes
AUTO LOGIC SEEKING	Yes	No	Yes	No	Yes
PROPORTIONAL PRINT CAPABILITY	Yes	Yes	Yes	No	Yes
EXTENDED CHARACTER SET	No	No	Yes	Yes	Yes
LETTER QUALITY PRINT	Yes	Yes	Yes	Yes	Yes
CUSTOM INTER-FACE OPTION	No	No	No	No	Yes
PRICE	£1675	£1950	£1950	£1450	£1450

The above information was gathered from distributors and abstracted from their current literature. Prices shown are those advertised at the present time.

MICROPUTE
microcomputer systems

Catherine Street, Macclesfield, Cheshire.
SK11 6QY. Tel: Macclesfield 612759

● Circle No. 198

WHEN IT COMES TO MICROCOMPUTER SOFTWARE WE WROTE THE BOOK

How do you stay up-to-the-minute with the rapidly changing world of microcomputer software? Get the Lifeboat Catalogue.

The latest innovations The new Lifeboat Catalogue is packed with the latest state-of-the-art software. And if we publish a new program after the latest catalogue has gone to press, we enclose a flash bulletin in your copy.

The greatest selection

Because Lifeboat is the world's largest publisher of microcomputer software, our catalogue offers you the greatest selection of programs for business, professional and personal use. Our more than 200 programs range from the integrated accounting and professional practice systems to office tools for book-keepers and secretaries to sophisticated tools for programmers. Included are business systems, word processors, programming languages, database management systems, application tools and advanced system utilities.

We specialise in software that runs on most small business computers. Our more than 60 media formats, including floppy disks, data cartridges, magnetic tape and disk cartridges, support well over 100 different types of computer.

Get full service We give the crucial dimension of after-sales service and full support to everything we sell.

That includes:

- An update service for software and documentation.
- Telephone, telex and mail-order services in the London office and at overseas offices in the United States, France, Switzerland, West Germany and Japan.
- Subscriptions to Lifelines,TM the monthly magazine that offers comparative reviews, tips, techniques, identified bugs and updates that keep you abreast of change.

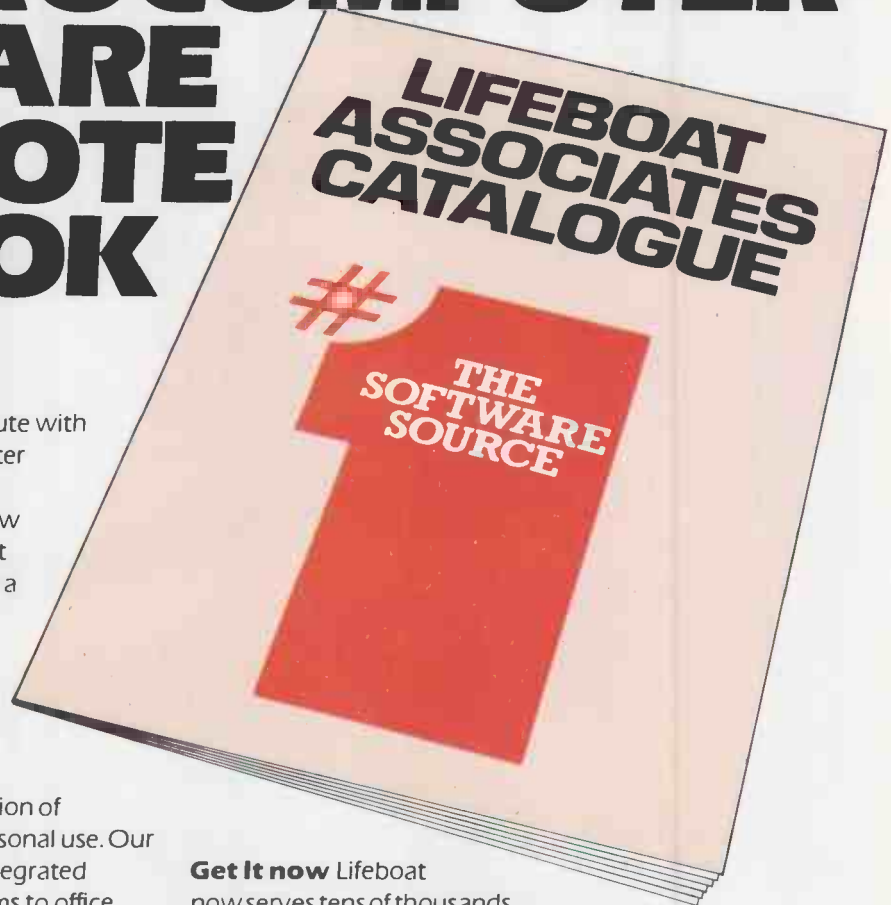

Get It now Lifeboat now serves tens of thousands of satisfied customers with our breadth of up-to-date, fully tested, fully supported and competitively priced software.

You may not need all we offer, but we offer just what you need. After all, we wrote the book.

Lifeboat Associates
World's foremost software source

Mail coupon to: Lifeboat Associates
PO Box 125, London WC2H 9LU or call 01-836 9028

Please send me a free lifeboat catalogue.

Name

Title

Company

Address

Postcode

Copyright © 1981, by Lifeboat Associates.

Lifeboat Worldwide offers you the world's largest library of software. Contact your nearest dealer of Lifeboat.

USA Lifeboat Associates 1651 Third Ave. New York NY 10028 Tel (212) 860-0300 Telex 640693 (LBSOFT NYK) TWX 710 581-2524 **JAPAN** Lifeboat Inc. OK Bldg. 5F 1-2-8 Shiba-Daimon Minato-ku Tokyo 105 Japan Tel 03-437-3901 Telex 2423296 (LBJTYO) **ENGLAND** Lifeboat Associates Ltd PO Box 125 London WC2H 9LU England Tel 01-836 9028 Telex 893709 (LBSOFTG) **SWITZERLAND** Lifeboat Associates GmbH Hinterbergstrasse Postfach 251 6330 Cham Switzerland Tel 042-36-8686 Telex 865265 (MICO CH) **WEST GERMANY** Intersoft GmbH Schlossgartenweg 5 D-8045 Ismaning W. Germany Tel 089-966-444 Telex 5213643 (JSOFD) **FRANCE** Lifeboat Associates SARL 10 Grande Rue Charles de Gaulle 92600 Asnieres France Tel 1-733-08-04 Telex 250303 (PUBLIC X PARIS)

● Circle No. 199



Recovering Basic

I AM SURE it has happened to you, writes David Breen of Nairobi, Kenya, introducing this month's best contribution. Two o'clock in the morning, and when you save the latest Basic program, CP/M reports a BDOS error and leaves you staring at that dreaded A>. How are you to get back into Basic? You know typing "MBasic" will cold start and lose three hours work.

All is not lost, if you follow this procedure:

- Correct the source of the BDOS error, for example, change the disc — not the MBasic one — and type a ^C to warm reset.
- Type

Save 0 @.COM Return

This saves a command file which does not load, but executes at 100 hex.

- Type "@ Return", which will now warm start Basic. You can now Run, List, and Save your program. If MBasic reports a syntax error, ignore it.

This is so useful, as it also allows rerunning any long Com file still in memory, with less waiting. I usually keep @.Com on my discs as it takes up zero bytes, except for a directory entry.

MBasic renumber

MANY USERS need to re-enter an MBasic line with a new line number to change the sequence of lines in a program, writes David Green of Nairobi, Kenya. Here is an example of how to renumber line 160 as line 500:

- Enter EDIT 160 followed by an extra Return: line 160 will then display.
- Type ^A, and an exclamation mark will be displayed.
- Type I to turn on insertion mode.
- Type 500 followed by Return.

The line will now be duplicated at 160 and 500, if you wish 160 may be deleted by typing 160, followed by Return. If you find you are doing a lot of this you will probably be better off if you save your program in ASCII mode by keying

SAVE "NAME",A

and use a text editor such as WordStar to make the alterations.

Paging text files

THIS CP/M PROGRAM from Jonathan Palfrey of Warwick, written for the Microsoft assembler, pages through a text file on the screen. On invocation it dis-

Paging text files.

```

.LBO
DFCB EQU 5CH
TAB EQU 9
LF EQU 10
CR EQU 13
EOF EQU 26
SPACE EQU 32

SETBYT MACRO ADDR,VALUE ; LD (nn),nn
LD HL,ADDR
LD (HL),VALUE
ENDM

INCBYT MACRO ADDR ; INC (nn)
LD HL,ADDR
INC (HL)
ENDM

DECBYT MACRO ADDR ; DEC (nn)
LD HL,ADDR
DEC (HL)
ENDM

FDOS MACRO FUNC ; call CP/M FDOS function
LD C,FUNC
CALL S
ENDM

DCIO MACRO CHAR ; direct console I/O
LD E,CHAR
FDOS 6
ENDM

OUT$ MACRO PTR$ ; output string to console
LD DE,PTR$
FDOS 9
ENDM

OPENF MACRO FCB ; open file
LD DE,FCB
FDOS 15
ENDM

READF MACRO FCB ; read from file
LD DE,FCB
FDOS 20
ENDM

ASEB ORG 100H

; start program:
OUT$ DL,LINE ; put message on console
OPENF DFCB ; open the named file
CP OFFH
JP NZ,LOOP1 ; if file not found,
OUT$ NDFILE ; stop
JP 0

; start main loop:
LOOP1: LD HL,RPTR ; check if end of buffer reached
LD A,OFFH
CP (HL)
JP NZ,NOREAD

READF DFCB ; if end of buffer, read new record
CP 0
JP NZ,0 ; if physical end of file, stop
SETBYT RPTR,BOH ; reset RPTR to beginning of buffer
JP GETCH

NOREAD: INC (HL)

GETCH: LD HL,(RPTR) ; get next character from buffer
LD A,(HL)
CP EOF
JP Z,0 ; if end of file marker, stop
JP TAB
JP NZ,NOTTAB

EXPTAB: DCIO SPACE ; output space to console
CALL EOLQ ; check for end of line
DECBYT POSB
LD A,(HL)
CP 0 ; reached next tab stop?
JP NZ,EXPTAB ; no? carry on spacing
LD (HL),0
JP LOOP1

NOTTAB: PUSH AF ; character is not a TAB
DCIO A ; output character to console
POP AF
CP CR ; if carriage return
JP NZ,NOTCR ; reset tab stop count
SETBYT POSB,B ; and check for 23 lines
CALL NEWLN
LD LOOP1

NOTCR: CP SPACE ; if not carriage return
JP NZ,LOOP1 ; don't count control characters
DECBYT POSB ; adjust tab stop count
LD A,(HL)
CP 0
JP NZ,POSBNZ
LD (HL),0
CALL EOLQ
LD LOOP1

; subroutines:
EOLQ: INCBYT LPOS ; check for end of screen line
LD A,(HL)
CP 81
RET NZ ; if end of line, fall through to:
NEWLN: SETBYT LPOS,I ; end-of-line routine
INCBYT LNUR ; count number of lines
LD A,(HL) ; and pause after 23
CP 24
JP Z,WAIT
RET

WAIT: DCIO OFFH ; wait for any key to be typed
CP 0
JP Z,WAIT
CP CR ; display just one line if CR
JP Z,ONELN
CP 3 ; stop program if ^C
JP Z,0 ; otherwise display 23 lines
SETBYT LNUR,I
ONELN: SETBYT LNUR,23
RET

DLIN$: DEFB 'PAGE 1 jpr palfrey 1 29 may 1981',CR,LF,'$'
NOFILE: DEFB 'file not found$'
RPTR: DEFB OFFH ; indicates position in read buffer
DFCB 0
LNUR: DEFB 1 ; counts number of output lines
LPOS: DEFB 1 ; indicates position in output line
POSB: DEFB 8 ; TAB expansion variable

```

plays the first 23 lines of the file named in the command line, then waits for:

Return:

when it displays the next line and waits;

Control-C:

when it returns to CP/M;

Any other key:

displays the next 23 lines and then waits.

It will cope intelligently with unusually long lines in the text file — the line count is of screen lines, not of CR-LF sequences in the file. In order to make this watertight, tabs are expanded explicitly in the program.

SYSTEM 4000 EPROM EMULATOR/PROGRAMMERS

EX-STOCK



P4000 PRODUCTION EPROM PROGRAMMER

This unit provides 'simple, reliable' programming of up to 8 EPROMs. It has been designed for ease of operator use — a single 'program' key starts the blank check — program — verify sequence. Independent blank check and verify controls are provided along with mode, pass/fail indicators for each copy socket and a sounder to signal a correct key command and the end of a programming run. Any of the 2704/2708/2716 (3 rail) and 2508 / 2758 / 2516 / 2716 / 2532 / 2732 EPROMs may be selected without hardware or personality card changes.

2 year warranty. Price **£545 + VAT:**
+ **£12.00 DELIVERY**

VM10 VIDEO MONITOR

This compact, lightweight Video Monitor gives a clean crisp picture on its 10" screen. Suitable for use with the EP4000, SOFTY and other systems. 12 month warranty. Price **£88 + VAT, carriage paid.**

MODEL 14 EPROM ERASERS



MODEL UV140 EPROM ERASER

Similar to model UV141 but with out timer. Low price at **£61.50 + VAT, postage paid.**

EP4000 EPROM EMULATOR/PROGRAMMER

The microprocessor based EP4000 has been designed as a flexible, low cost, high quality unit for emulating and programming all the popular NMOS EPROMs without the need for personality cards, modules or hardware changes. Its software intensive design permits selection of the 2704 / 2708 / 2716 triple rail EPROMs and the 2508 / 2758 / 2516 / 2716 / 2532 / 2732 single rail EPROMs for both the programming and emulating modes.

The video output (T.V. or monitor) for memory map display in addition to the built-in Hex LED display, for stand alone use, is unique in this type of system. This, with the double function 28 key keypad, powerful editing features, powered down programming socket, buffered tri-state simulator cable and 4k x 8 data RAM gives you the most comprehensive, flexible and compact systems available today.

2 year warranty. Price **£545 + VAT:**
+ **£12 DELIVERY**

MODEL UV141 EPROM ERASER

- 14 EPROM capacity
- Fast erase time
- Built-in 5-50 minute timer
- Safety interlocked to prevent eye and skin damage
- Convenient slide-tray loading of devices
- Available Ex-Stock at **£78 + VAT** Postage Paid

EX-STOCK

DISTRIBUTORS REQUIRED — EXPORT ENQUIRIES WELCOME

GP INDUSTRIAL ELECTRONICS LTD,

UNIT E, HUXLEY CLOSE, NEWNHAM INDUSTRIAL ESTATE,
PLYMOUTH, DEVON PL7 4JN

TELEPHONE: PLYMOUTH (0752) 332961 (Sales) / 332962 (Technical Service).

SOFTY SYSTEMS

EX-STOCK



SOFTY 2 LOW COST 2716 EMULATOR/PROGRAMMER

● Direct output to T.V. ● High speed cassette interface ● On card EPROM Programmer ● Multifunction touch keypad ● 2K Monitor in 2716 ● 2K RAM ● 128 byte scratchpad RAM ● 2K EPROM Emulation ● Can program 2732/2532 in two halves ● Editing facilities including — Data entry/deletion, Block shift, Block store, Match byte, Displacement calculation ● Supplied with ZIF socket, Simulator cable, comprehensive manual, Antistatic lined EPROM tray and PSU. **SOFTY 2 £169 + VAT** (includes p&p)

SOFTY 1 LOW COST 2704/2708 EMULATOR/PROGRAMMER

● Direct output to T.V. ● High speed cassette interface — On card EPROM Programmer ● Multifunction keypad ● 1K Monitor in 2708 ● 1K RAM ● 128 byte scratchpad RAM ● 1K EPROM Emulation ● Comprehensive editing facilities ● Supplied with ZIF socket, Simulator cable and comprehensive manual.

SOFTY 1 (Built and tested) **£120 + VAT**

SOFTY 1 Power Supply **£20 + VAT**

SOFTY 1 CONVERSION CARD

Enables SOFTY to program the single rail EPROMs, 2508 / 2758 / 2516 / 2532. Selection of device type and 1K block are by pcb slide switches. ZIF Programming socket. Supplied built and tested. **£40 + VAT.**

EX-STOCK EPROMS

	1-24	25-99	100 up
2732	6:50	5:75	4:95
2716	2:80	2:60	2:40
2708	2:80	2:60	2:40

ADD VAT AT 15% — POSTAGE PAID

WRITE OR TELEPHONE FOR DETAILS
ON ANY OF OUR PRODUCTS

● Circle No. 200



Quick formatter

THE ABSENCE of a Print Using function is a serious drawback to the Pet user, writes M C Hart of Wigston, Leicestershire, and Commodore has not rectified the position with the release of Basic 4.0.

Of course there are "quick and dirty" methods of achieving the neat output particularly of columns of figures but they all suffer from a series of drawbacks, such as not coping with numbers in exponential format. On the other hand some of the Print Using routines that have been published are exceptionally long and complex and not easily adapted to suit the particular needs of the user.

Having originally developed a fairly long formatting program that covers most

of the contingencies provided by the Print Using statement, I decided to scale down my original program to provide the bare elements that I would want a Print Using to achieve. These are:

- to round both positive and negative numbers correctly, avoiding the rogue .000001s that the Pet arithmetic function occasionally tags on to the end of certain numbers;
- to take care of the exponential format of numbers less than 0.01;
- to put in leading zeros for values less than ± 1 ;
- to add a fractional part of trailing zeros to integers to ensure consistency with other output, for example, 2 becomes 2.000.

Other criteria I kept in mind were:

- that the routine should be economical and be contained in as few lines of coding as possible; those without Toolkits and the Append function can always tag it on to the end of a program quickly by typing in from the keyboard;
- that it should be easy to understand and be capable of alteration and expansion to meet particular needs

The routine eventually developed requires only four lines of code and 178 bytes. For a Basic routine it is quite fast, each subroutine call taking on average 80ms.

Line 60000 rounds the absolute value and converts both the integer and the fractional part into separate strings

Line 60010 pads the fraction string with zeros and then reconstructs an output string. If integer output is chosen, the decimal point is eliminated.

Quick formatter output.

```

Quick-formatter
By M. C. Hart
press <return> only to retain sample
VALUES ... OTHERWISE SUBSTITUTE YOUR
OWN.
    
```

```

---required field length is 11
---number of decimal places in
FIRST FIELD IS 4
---number of decimal places in
SECOND FIELD IS 1
=====
.114041549      0.1140      0.11
-958.227017     -958.2270     -958.23
180.518585      180.5186      180.52
-31.9237856     -31.9238      -31.92
404.860335      404.8603      404.86
14.6913429      14.6913      14.69
14.1522637      14.1523      14.15
-1.36321782     -1.3632      -1.36
-.599575934     -0.5996      -0.60
.618702668      0.6187      0.62
.588787114      0.5888      0.59
-.594855181     -0.5949      -0.59
.176296465      0.1763      0.18
.602271626      0.6023      0.60
.161926194      0.1619      0.16
    
```

AVERAGE FORMATTING TIME= .0333 SECS

```

another run (y/n) y
===end of demonstration===
    
```

Line 60020 restores the minus sign for negative numbers, stripped off by the Abs function in line 60000.

Line 60030 pads the output string to the left with blanks and then returns.

If space and/or time are not so critical then it is possible to add an extra line to signal over-long output — see lines 60480 to 60560. Similarly, accountants often like to work with trailing rather than with

(continued on next page)

Quick formatter.

```

100 PRINT "***** QUICK-FORMATTER "
110 PRINT "***** BY M. C. HART "
120 FOR J=1 TO 2000: NEXT
130 PRINT "PRESS <RETURN> ONLY TO RETAIN SAMPLE"
140 PRINT "VALUES ... OTHERWISE SUBSTITUTE YOUR"
150 PRINT "OWN." PRINT
160 PRINT "---REQUIRED FIELD LENGTH IS 11"
170 INPUT "FIELD: "; ZF: PRINT: IF ZF < 9 THEN PRINT "!!! FIELD TOO SHORT !!!": GOTO 160
180 ZF$=LEFT$(ZF, ZF)
190 PRINT "---NUMBER OF DECIMAL PLACES IN"
200 PRINT "FIRST FIELD IS 4"
210 INPUT "FIELD: "; ZP: PRINT
220 PRINT "---NUMBER OF DECIMAL PLACES IN"
230 PRINT "SECOND FIELD IS 1"
240 INPUT "FIELD: "; ZQ: PRINT
250 PRINT "OR RANDOM VALUE          FORMATTED VALUE          " PRINT
260 ZL=3
270 FOR J=1 TO 15: ZD=ZP: ZR=1: IF ZD > 0 THEN FOR I=1 TO ZD: ZR=ZR*10: NEXT I
280 Z=EXP(RND(0)*14-6)*SGN(RND(0)-.2)
290 ZD=Z: PRINT Z: A=TI: GOSUB 60000: B=TI: TT=TT+(B-A)
300 PRINT SPC(15-LEN(STR$(Z)))Z$:
310 ZD=ZQ: ZR=1: IF ZD > 0 THEN FOR I=1 TO ZD: ZR=ZR*10: NEXT I
320 GOSUB 60000: PRINT Z$: NEXT J
330 TT=TT/(15*60): T2=INT(TT*10000+.5)/10000
340 PRINT: PRINT "AVERAGE FORMATTING TIME="T2"SECS"
350 FOR J=1 TO 35: PRINT " ": NEXT: PRINT
360 PRINT "ANOTHER RUN (Y/N) Y " INPUT "FIELD: "; A$
370 IF A$="Y" THEN 130
380 PRINT: PRINT "***** ===END OF DEMONSTRATION=== *****": END
390 :
400 :
410 :
500 :
60000 Z1=INT(ABS(Z)*ZR+.5)/ZR: ZX=Z1: ZX$=STR$(INT((Z1-ZX)*ZR+.5)): ZT$=STR$(Z)
60010 ZY$=RIGHT$("00000"+MID$(ZX$, 2), ZD): Z$=ZT$+"."+ZY$: IF ZD=0 THEN Z$=STR$(Z1)
60020 IF Z < 0 THEN Z$="-"+MID$(Z$, 2)
60030 Z$=RIGHT$(Z$+Z$, ZF): RETURN
60040 :
60050 :
60060 :
60070 :
60080 : REM *** TABLE OF VARIABLES **
60090 :
60100 : REM --MAIN PROGRAM--
60110 : REM
60120 : REM ZP = NO OF DECIMAL PLACES
60130 : REM
60140 : REM REQUESTED FOR FIELD 1
60150 : REM ZQ = NO OF DECIMAL PLACES
60160 : REM REQUESTED FOR FIELD 2
60170 : REM ZD = NO OF DECIMAL PLACES
60180 : REM USED IN PROGRAM
60190 : REM ZR = ROUNDING FACTOR
60200 : REM ZF = REQUESTED FIELD LENGTH
60210 : REM ZF$ = STRING OF BLANKS FOR
        PADDING
60220 : REM ZL = INTEGER LENGTH +1
60230 : REM ZC = COPY OF Z (=VALUE FOR
        FORMATTING)
60240 : REM
60250 : REM
60260 : REM ---FORMATTING SUB-ROUTINE---
60270 : REM -- (CALLED AT 60000) --
60280 : REM
60290 : REM Z = VALUE FOR FORMATTING
60300 : REM Z1 = ROUNDED ABSOLUTE Z
60310 : REM Z% = INTEGER OF Z1
60320 : REM ZX$ = STRING OF FRACTION
60330 : REM ZT$ = STRING OF INTEGER
60340 : REM ZY$ = ZX$ PADDED WITH ZEROS
60350 : REM ZD = NO OF DECIMAL PLACES
60360 : REM USED IN PROGRAM
60370 : REM ZR = ROUNDING FACTOR
60380 : REM ZF$ = STRING OF BLANKS FOR
        PADDING
60390 : REM ZF = LENGTH OF FIELD
60400 : REM Z$ = OUTPUT STRING
60410 : REM
60420 :
60430 : REM FOR TRAILING RATHER THAN
60440 : REM LEADING "-" ALTER 60020 TO
60450 : REM Z$=Z$+" " : IF Z < 0 THEN Z$=
60460 : REM LEFT$(Z$, LEN(Z$)-1)+"-"
60470 :
60480 : REM TO SIGNAL INTEGER PART TOO
60490 : REM LONG FOR A FIELD THEN :-
60500 : REM -SET 'ZL' TO INTEGER LENGTH
60510 : REM (INCLUDING LEADING SPACE)
60520 : REM IN MAIN BODY OF PROGRAM
60530 : REM E.G. IN LINE 260
60540 : REM -INSERT NEW LINE 60025
60550 : REM (60025) IF LEN(ZT$) > ZL THEN
60560 : REM Z$=" "+MID$(Z$, 2)
60570 :
60580 : REM ** END OF INSTRUCTIONS **
    
```

(continued from previous page)

leading minus signs, and this can be accommodated by changing line 60020 — documented in lines 60430 to 60460.

If users would like output to contain a leading character, such as a \$ sign for financial transactions, this can be accommodated by the addition of one extra line as follows:

```
60015 Z$="$"+MID$(Z$,2): IFZ<0 THEN
Z$="-"+Z$: GOTO 60030
```

The rounding function is placed at 270 and 310 in the main body of the program in order to save processing time, but if time is not at a premium and it is desirable to change formats within a program it is always possible to place it within the subroutine if desired.

ROM remover

SEVERAL TIMES in the past few months I have had to swap two alternative video character-generator ROMs in my Pet, and on one occasion the pins of one of them were irreparably damaged, writes Dan Rogers of Bexhill-on-Sea, Sussex. To avoid a repetition I made a loop of tape which I now keep entrapped under the ROM as shown in the sketch.

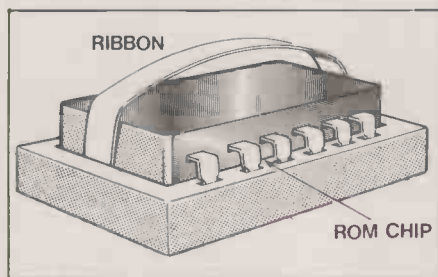

With two or three fingers of one hand in the loop an even lift can be exerted while the other hand controls the rate of withdrawal. Baby or shoulder-strap ribbon 7-10mm. wide seems eminently suitable: it is thin, strong and has reinforced edges. Adjust the length to suite the dimensions of the ROM.

Dodgeball

LIKE MOST popular video games, Dodgeball by Greg Hopkins of Reigate, Surrey is very simple yet in concept difficult to master and interesting enough to be played again and again. At the beginning all the player has to do is to dodge out of the way of a ball which is bouncing around a box on the screen. Another ball then appears, and then another; gradually the whole screen fills up with fast-moving circles which destroy everything in their paths, including sometimes the other balls. The player is forced to think more and more quickly in order to survive. The time in seconds is shown at the top of the screen — anything over one minute is a very good score.

In Basic the program would be far too slow to be playable, so a 260byte machine-code program to move the balls. The game was written on a new-ROM

Pet but it will run equally well on an old-ROM machine if the keyboard check in line 590 is changed to Peek (515).

The program is split into three main sections. The first part prints instructions and Pokes the machine code into memory; the second sets up the variables and prints the box of random dimensions on

to the screen. The final section is where the game is played.

After each part the computer waits for a key to be pressed before continuing. The level of difficulty can be altered by increasing or decreasing the value of the variable, originally set at 0.0002, in line 570.

Dodgeball.

```
0 REM*** DODGEBALL - BY GREG HOPKINS***
100 DATA 72, 169, 16, 141, 75, 232, 169, 15, 141, 74, 232
110 DATA 169, 64, 141, 72, 232, 184, 76, 96, 16, 78
120 DATA 234, 234, 234, 234, 234, 234, 234, 234, 234, 234
130 DATA 234, 96, 170, 170, 170, 170, 170, 234, 32, 16
140 DATA 64, 32, 16, 64, 32, 64, 16, 169, 0, 133
150 DATA 177, 133, 179, 169, 128, 133, 180, 169, 20, 133
160 DATA 178, 160, 90, 234, 234, 234, 234, 234, 234, 230
170 DATA 177, 230, 179, 208, 12, 230, 178, 230, 180, 169
180 DATA 131, 197, 180, 240, 202, 234, 234, 177, 179, 201
190 DATA 81, 208, 82, 177, 177, 168, 177, 179, 201, 32
200 DATA 208, 153, 152, 201, 90, 16, 84, 145, 177, 169
210 DATA 81, 145, 179, 160, 90, 169, 32, 145, 179, 152
220 DATA 145, 177, 76, 38, 16, 234, 234, 201, 227, 208
230 DATA 11, 152, 24, 105, 80, 160, 90, 145, 177, 76
240 DATA 56, 16, 234, 201, 229, 208, 11, 152, 24, 105
250 DATA 2, 160, 90, 145, 177, 76, 56, 16, 234, 201
260 DATA 228, 208, 44, 152, 56, 233, 80, 160, 90, 145
270 DATA 177, 76, 56, 16, 234, 177, 177, 201, 90, 240
280 DATA 144, 169, 81, 145, 179, 76, 38, 16, 234, 234
290 DATA 234, 145, 177, 76, 82, 16, 170, 170, 170, 170
300 DATA 170, 170, 170, 170, 170, 170, 170, 201, 231, 208
310 DATA 11, 152, 56, 233, 2, 160, 90, 145, 177, 76
320 DATA 56, 16, 234, 76, 71, 16, 170, 170, 170, 170
330 DATA 170, 170, 170, 170, 170, 170, 170, 170, 170, 160
340 DATA 90, 169, 20, 133, 178, 169, 0, 133, 177, 230
350 DATA 177, 169, 90, 145, 177, 165, 177, 208, 246, 230
360 DATA 178, 165, 178, 201, 23, 208, 238, 96,
370 PRINT"O"SPC(13);"DODGEBALL"
380 PRINT"YOU LOOK LIKE THIS: O"
390 PRINT"THE BALLS LOOK LIKE THIS: O"
400 PRINT"AVOID THEM BY USING THE NUMBER KEYBOARD"
410 PRINT"SEE HOW LONG YOU CAN SURVIVE !!!"
420 IFPEEK(4064)>72THENFORX=4064TO4332:READB:POKEX,B:NEXT
430 GETA$:IFA$=""THEN430
440 SYS4304
450 W=INT(RND(0)*30)+8:H=6+INT(RND(0)*10)
460 T=18-INT(W/2)
470 P=32768+(INT(RND(0)*(W-2)))+(INT(RND(0)*H)*40)+202+T
480 PRINT"SPC(T)";
490 FORX=1TOH+2:PRINT" ";:NEXT:PRINT
500 FORX=1TOH+2:PRINTSPC(T);" ";SPC(W)";":NEXT
510 PRINTSPC(T);:FORX=1TOH+2:PRINT" ";:NEXT:PRINT
520 GOSUB700:POKEP,87
530 GETA$:IFA$=""THEN530
540 TI#="000000"
550 SYS4112:POKE59467,0
560 TJ=INT(TI/6)/10:PRINT"SPC(T+.5*W+2-LEN(STR$(INT(TJ))))";TJ
570 IFRND(0)>1-H*W*.0002THENGOSUB700
580 IFPEEK(P)>87THEN740
590 L=PEEK(151):IFL=255THEN550
600 IFL=50THENA=-40:GOTO680
610 IFL=18THENA=40:GOTO680
620 IFL=41THENA=1:GOTO680
630 IFL=42THENA=-1:GOTO680
640 IFL=57THENA=-39:GOTO680
650 IFL=58THENA=-41:GOTO680
660 IFL=25THENA=41:GOTO680
670 IFL=26THENA=39
680 IFPEEK(P+A)=32THENPOKEP,32:P=P+A:POKEP,87
690 GOTO550
700 D=201+(INT(RND(0)*W)+(INT(RND(0)*H)*40)+T
710 V=INT(RND(0)*2)*80+INT(RND(0)*2)*2+49
720 IFPEEK(32768+D)=32THENPOKE32768+D,81:POKE5120+D,V
730 RETURN
740 PRINT" ";:FORX=1TOH+6:PRINT:NEXT
750 IFTJ<RTHEN770
760 PRINT"CONGRATULATIONS A NEW RECORD":R1=TJ
770 PRINT"THE RECORD WAS"R"SECONDS"
780 R=R1:PRINT"ANOTHER GAME ?"
790 GETA$:IFA$=""THEN790
800 IFA$="Y"THEN440
810 IFA$="N"THENEND
820 GOTO790
READY.
```



THE GALAXY 1 COMPUTER

The cost effective solution to your computer needs for only **£1,450***

The Galaxy 1 desk top computer system can be used in education, small business applications, word processing, stock control and a host of other environments. Our choice of CP/M as the operating system means that our customers can select a suitable application package from the widest possible range.

However, unlike our competitors, we supply not only the hardware but all the essential system software needed to start using the Galaxy 1 as soon as it is installed. We have adopted COMAL-80 as our standard language. This structured basic is rapidly gaining widespread acceptance and popularity especially in the education market, offering much greater flexibility and ease of use than existing Basics. We also supply a very powerful Z80 assembler/editor called GEM ZAP with GEM PEN, a compact but very powerful word processing package. The system software suite is completed with GEM DEBUG, a useful machine code program de-bugging utility.

Modular design means reliability and ease of maintenance. Unlike many other manufacturers Gemini offer a full one year warranty (except Disc heads which are guaranteed for 3 months). Our distributors carry a full range of replacement boards thereby facilitating a quick, efficient and cost effective back up customer service.

Features include:

- Twin Z80 Processors
- 64K Dynamic RAM
- 800 K Disc Based Storage
- 80×25 Screen Format
- Dual Printer Interfaces
- Modular Design
- CP/M 2.2 Operating system
- COMAL-80 – Structured Basic
- Z80 Editor/Assembler
- Text Editor & Formatter
- Program De-Bugging Utility

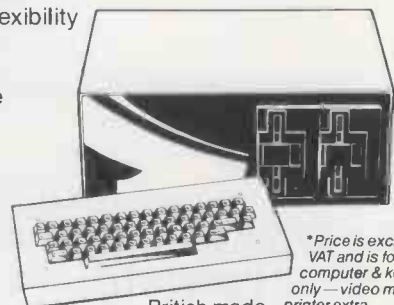

British made

*Price is exclusive of VAT and is for computer & keyboard only — video monitor & printer extra.



Telephone Amersham 28321 for the name and address of your nearest distributor.
* Dealer enquiries invited.

Gemini Microcomputers Oakfield Corner, Sycamore Road, Amersham, Bucks HP6 5EQ.

● Circle No. 201

PRACTICAL COMPUTING August 1982

Computer Hardware/Software Tenders Required

Our client markets a wide range of mini/microcomputer products in Ireland with outstanding performance and price advantages.

Recent changes in Marketing thrust have necessitated the need to acquire new/additional sourcing of peripherals such as visual display units, printers etc. and professional software.

As a result of this situation, we have been commissioned to invite manufacturers and/or suppliers to submit tenders for the supply of one or all of the requirements listed below:

Visual Display Units (VDU's): which would be capable of supporting a range of microcomputer handling, word processing, financial modelling, business packages, etc.

Printers: with daisy wheel and dot matrix printers — 80/132 column width, speed 40 to 240 cps, multiple copy sheet feeder. Options on colour printers should be included (if applicable). Each tender should include technical specifications along with distributor/dealer/OEM quantity discount pricing, including information on sole representation in Ireland (if applicable), delivery, maintenance, technical and marketing support available; include any other relevant information.

Micro/Mini Software Packages: with compatibility for micro's on CP/M and/or UNIX systems, and for mini's on standard mini computer operating systems. Packages should cover, for example:

- Small Business Accounting Packages
- Insurance
- Solicitors
- Pharmacy
- Dental and Medical
- Estate Management
- Others

After a suitable evaluation period all tenders received will be acknowledged. All tenders may be submitted in confidence to:

**INTELLIGENCE (IRL) LTD.,
35 MONALEA WOOD, TEMPLEOGUE, DUBLIN 16, IRELAND
Attention: Mr M. P. Smith, Managing Director**

Using Microcomputers in Business

By Stanley S Veit. Published by Hayden. Paperback \$9.95. ISBN 0 8104 5152 2.

THIS BOOK is intended for the would-be business user of a small computer system which, despite the title, could equally well be a minicomputer. The author maintains that the advice given has been valid since businesses started using computers, and will remain so in the future.

The book breaks down into two elements, the first concerned with describing what a computer system is and what it can do in the context of a business. The second explains the pitfalls and how to avoid them on the way to computerising a business.

The description of computer hardware and how it can be used in business is no better or worse than countless other books. Two chapters are devoted to word processing and database management systems, and both consist of a limited explanation of the facilities provided by a typical system, filled out with outlines of commercially available software packages. These outlines provide no more information than suppliers' advertisements or sales brochures — a lazy way of writing a book. There is also a chapter describing the more popular languages.

The second element is concerned with selecting, installing and using a computer system in a business environment. The coverage of this topic is so much better than the description of the computer systems that this must be the area in which the author's experience really lies. He makes the point that the buyer must know in some detail what the computer is to do and how, before starting to spend time and money on choosing a computer system or a consultant.

The advice goes into much more detail on how this may be achieved, and provides a similar level of advice on selecting both the hardware and software, installation and the need for continuing support from the suppliers after installation. The author also makes a good case for using

consultants — not really surprising when he is a consultant himself, but no less valid for all that.

Conclusions

● This book is subtitled a "Guide for the Perplexed", but the technical descriptions will only add to the confusion.

It is not specially bad, but like most books of this type it is rather superficial — perhaps because the author himself does not really understand it.

● The sections on selecting, installing and using a computer system contain excellent advice and probably justify buying the book. Any new user who followed the advice diligently would end up with a satisfactory system.

● A very uneven book whose purchase is worthwhile for the half that is good.

Martin Wilson

Starting Forth

By Leo Brodie. Published by Forth Inc. 348 pages. £12.80.

AN IMPORTANT FACTOR in the success of any computer language is the quality of the supporting literature. It is therefore clear that if Forth is to be successful it needs a high-quality book on the subject. Fortunately this book is it.

The foreword includes a eulogy in praise of the author by the originator of Forth, Charles H Moore and is the only part of the book to jar a little. The user wants to know about the language not about the personal qualities of the author.

Forth is in many respects a difficult language, but this book is distinguished by the clarity with which the complexities of the language are presented. The author uses graphics intelligently, especially in his discussion of stack-manipulation operations. Unlike many texts it has a good, almost conversational, style throughout and even the most naive user could learn the basics of the language from this text. It is a measure of the quality of the book that I read over 200 pages at one sitting without feeling overstuffed with information or bored at the end.

My only reservation stems from a remark about Forth attributed elsewhere to Charles Moore, in which he

describes the language as amplifying the capabilities of good programmers and making bad programmers worse. There is not enough in the book to help the completely naive programmer to approach program design in the right manner.

Conclusions

● An excellent book, destined to be the Forth bible I suspect.

● Probably the book is most suitable for programmers who already have some experience of program-design principles acquired using another language.

John Cookson

Computer Software Protection

Editor Robert Muller. Published by Gower Publishing. 113 pages paperback. ISBN 0 566 03418 2

THIS BOOK is the edited transcript of the proceedings of a conference held during 1981. Though well covered in the computer press at the time, this "Computing in Business Report" contains more detail than the magazine articles published then.

The report starts with the editor's introduction which effectively sets the scene by outlining the development of software piracy and the consequent need for protection against such illicit copying. The introduction summarises the current methods used for software protection, both legal and illegal.

The first chapter describes the problem that illegal copying causes for those trying to market software and the need to plan for taking action against piracy. This covers preventative measures such as devices in the software to deter or, for some people, encourage copying, and the limited or doubtful legal remedies after the infringement.

The second chapter details some of the abuses and misuses and the consequent losses to those writing and selling software. It also highlights the consequent loss of choice to the would-be honest buyer because of the reduction of the number of software products that can pay their way in publishers' and dealers' lists, despite the piracy.

The third chapter provides

the reasons for much illicit copying, for demonstration or evaluation purposes or purely to provide back-up or a realistic working environment. It is also suggested that much software is overpriced for its potential market and that few software houses have a realistic approach to multiple machine licences. A better level of service for annual licences, it is contended, would provide more encouragement to purchase legitimate copies rather than pirated ones.

The ever-present Mr Kelman provides his usual comprehensive treatise on the legal protection provisions and on the possible extension of legislation to cover software copyright. The latter chapters cover not only the conventional but some very unconventional approaches to the deterrence of illicit copyists. Hardware techniques such as the now infamous "dongle" are outlined, as are the effective approaches of using the legal system to cause the would-be pirate the maximum amount of embarrassment and to warn off his potential customers.

The final chapter, like the final section of each of the previous chapters, is a discussion among the panel members and a response to points raised from the floor of the conference. Many interesting questions were asked and perhaps there could have been more made of this aspect.

The appendices provide details of copyright legislation, both proposed and enacted, in the U.K. or the U.S.A. Also included is a summary of copyright limitations worldwide and an outline of some typical copyright problems.

Conclusions

● An interesting and thought-provoking discussion for anyone involved in the marketing of software. Much is already familiar thanks to the extensive coverage of this subject by the computer press, this book brings much of the thinking into one slim volume.

● This book raises more questions than it answers, but provides a useful starting point for the resolution of this serious problem.

Martin Wilson

**OUR SUPERBRAIN PRICES
ARE THE LOWEST IN THE UK**

Orders over £3,000 — sign a one year comprehensive service contract costing 8% of your order value and we will give you a one year free warranty so that your system will be covered for full parts and labour servicing for a period of two years.

THE ONLY SYSTEM
BETTER THAN A
MICRO NETWORK'S
SUPER 6
IS THE
SUPER 12

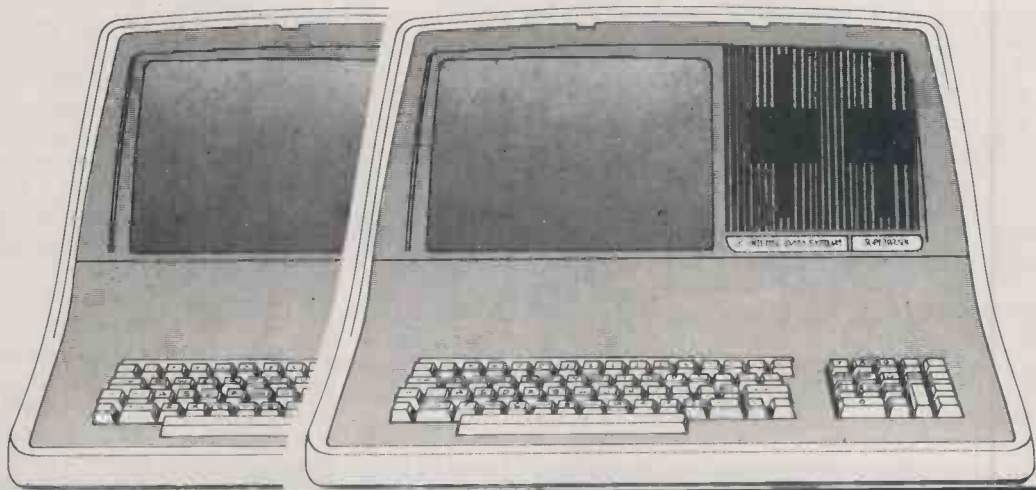

Micro Networks Ltd can now exclusively offer you a super Superbrain that includes either six or twelve megabytes, 5.25 inch Winchester Disk Drives interchangeable with floppies. The new system is supplied with customised version of CP/M that allows the user to treat the hard disc as single or multiple logical drives. Any of these drives can be of any size up to the maximum capacity of the disc drive involved, i.e. 150 up to 790 K bytes per single drive. They can be intermixed with each other or with the hard disc logical drive. Obviously, the incorporation of Winchester drives not only expands the bulk storage available but it also speeds up the access five times faster on floppies and ten times faster on hard disc than on ordinary Superbrain.

There's more very good news too! Superbrain and

CompuStar prices have been reduced by 30% plus the NEW SUPERBRAIN II features, which include a faster enhanced disc operating system, a library of new visual attributes including below-the-line descenders, reverse video and impressive graphics capabilities.

Standard software in stock includes Wordstar, Mailmerge and Spellstar, BASIC-80, FORTRAN-80, COBOL-80, ALGOL-80, PASCAL M, CIS COBOL, plus many application packages.

If you already have a system — ask us about our service and maintenance schemes.

MICRO NETWORKS
60 PALL MALL LONDON 01-839 3701

● Circle No. 203

PRACTICAL COMPUTING August 1982

Highland mystery

by Douglas Tate

AN AMATEUR archeologist and anthropologist who has been studying the early electronic artefacts of the ancient peoples who live north of the wall was most stimulated by the new Rosetta stone which appeared on page 165 in *Practical Computing's* June issue.

Imagine his delight when he was able with the help of our listing to at last decipher the ancient Highland PCB* which is believed to antedate the simple Skye matrix. Its markings are reproduced here.

An exceedingly ancient, bearded

*Practical Computing Bible

and kilted apparition provided a clue to its solution, which runs as follows: "Sir. This is as twisted as my stick, not straight and nasty like your English ones. Our ancestors never wasted a thing but, like a haggis, you can only eat each bit the once".

Our anthropological correspondent is sure that you will instantly see the significance of the remark and be able at once to decipher the code on the stone.

Solution to July puzzle

C L A C Y R O M O C R E T R P H T
 B I S S G M E M E M P U C O F O R C
 N A P A P R A P D O M E S R O T I P
 A V D R I N A O R A M S O R P I N M
 R U C R E T P C R H C I E E E L O M
 E T I G O L H E N I A M M I B O T T
 R W R A C I S Y S T E M I N O O T I
 A D R O H E P I C C C L O B Y O F B
 N O A M F L I P H O A O I T P L G O
 C I R O E E K S M S G L E K P O R R
 L I F R C I T I S A L W O Y B L A P
 S N I A M M T E D B U S D R O C M



TWICKERS MADNESS!

ZX81 OWNERS **VIC-20**
OFFICIAL STOCKISTS

We will allow **£40** off the purchase price of a VIC-20 & Cassette Deck in exchange for a complete working ZX81

In stock for the VIC now: Printers, Disk Drives, Games, Stack Range, Arfon Range, Vicmen, PR Soft, Books, Aliens, Dead Frogs, Dust Covers, Taysoft, Robot Zap, etc.

Considering an Apple Package?  **apple**
OFFICIAL STOCKISTS

Then ring Mick or Dave on 01-891 1612 for a mind-boggling low quote - you won't believe it!

In stock now: Colour Cards, Mathemagic, Books, Printers, Disk Drives, Visicalc, Visifile, Visimadness, Dragons, Caves, The 'Mill, Word Processors

Also in stock:

- Epson MX80FT2 £399 (incl VAT)
- Prince 12" Green Screen Monitor £115 (incl VAT)
- Haga 14" Colour Monitor £299 (incl VAT)
- C15's 10-pack £4.50 (incl VAT)
- C30's 10-pack £5.50 (incl VAT)

Offers available whilst current stocks last!

- ★ Computer stationery
 - ★ The Alpha Numeric Taniel
 - ★ Disc Library Cases
 - ★ The Top Twenty Computer Books
 - ★ Chips ★ Leads ★ Interfaces
- PS: We've just planted an Acorn.

TWICKENHAM WE'VE GOT MIKRO
COMPUTER CENTRE LTD GEN PRODUCTS IN
72 North Rd Twickenham Middlesex TW1 4BW (01-892 7890/01-891 1612) STOCK - SO THERE!

● Circle No. 204

Turn to Computer Plus

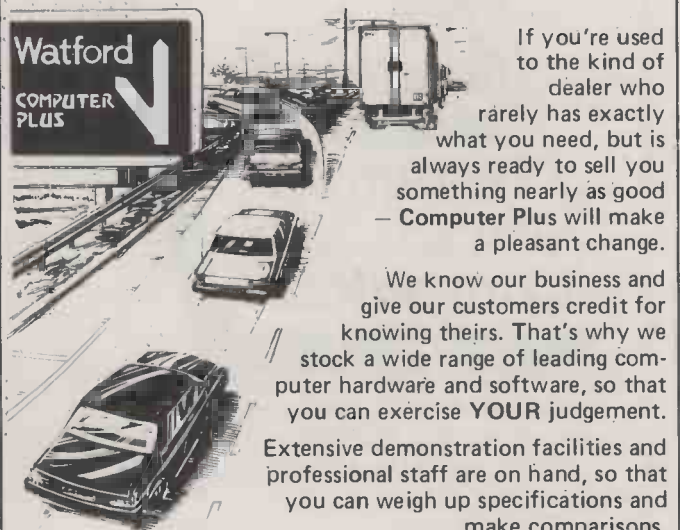

If you're used to the kind of dealer who rarely has exactly what you need, but is always ready to sell you something nearly as good - Computer Plus will make a pleasant change.

We know our business and give our customers credit for knowing theirs. That's why we stock a wide range of leading computer hardware and software, so that you can exercise YOUR judgement.

Extensive demonstration facilities and professional staff are on hand, so that you can weigh up specifications and make comparisons.

We have excellent sales back up service and credit facilities for our customers.

When you turn to Computer Plus you can be sure you have taken a turn in the right direction.

COMPUTER PLUS, 47 QUEENS ROAD, WATFORD
TELEPHONE: WATFORD 33927

● Circle No. 205 165

LOW COST WORD PROCESSING PRINTER

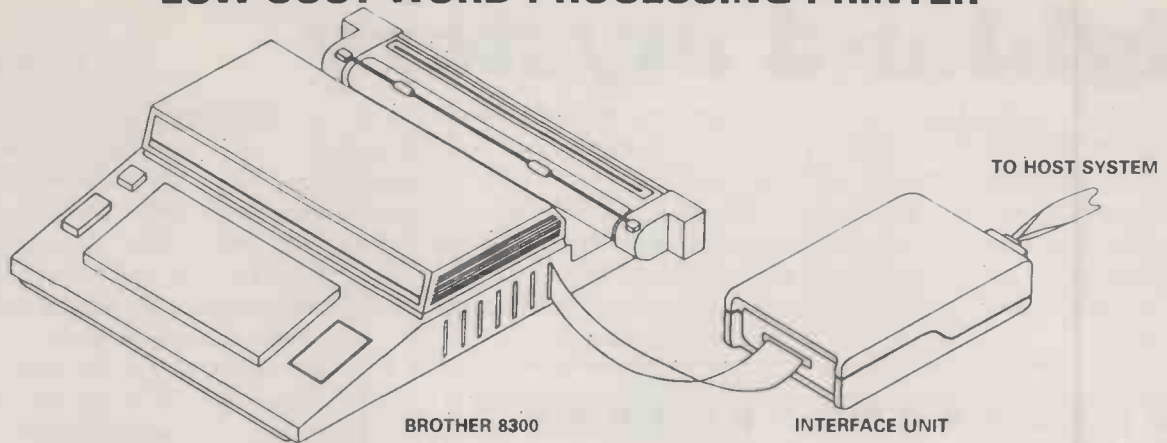

- * Daisy wheel typewriter/printer
 - * RS232 or Contronics-parallel interface
 - * Low cost — high quality printing
- £459.00 (+ £68.85 VAT) (+ £8.50 P&P)

Available now



SYSTEMS OF TOMORROW LTD

COMPUTER CONSULTANTS

109c, HIGH STREET, CHESHAM, BUCKS, HP5 1DE.

CHESHAM | 0494 | 786989.

● Circle No. 207

MICRO RAPPOR T

The Relational Database System for Micro Computers

For more information or to order your copies of MicroRAPPOR T just contact: Peter Barnes, Database Products Group, Logica Limited, 64 Newman Street, London W1A 4SE Telephone: 01-6379111

MicroRAPPOR T is a proven Relational DBMS for CP/M* based microcomputers. It has an easy to use Interactive Query Language for retrieving data and formatting simple reports, a utility program for loading data and a powerful command interface for use within Fortran programs. It is a derivative of RAPPOR T, the popular DBMS for mini and mainframe computers.

MicroRAPPOR T can handle 16 data-base files holding up to 30 Megabytes of data. It is powerful, very efficient and proven on a wide range of machines

logica

*CP/M is a trademark of Digital Research.

● Circle No. 206

BUYERS' GUIDE SOFTWARE

Software packages are listed by application, in alphabetical order, with the systems on which each package will run also listed alphabetically. The guide is not exclusively for business applications: if your company is the source or dealer for a package with a more unusual application, send us the details and we will create a new category.

The usual criteria have been applied. The minimum configuration is 32K of RAM, a disc and a printer; the price of the package must lie between £50 and £3,000; the companies listed are the source of the software or the main dealers in the U.K., and the capacity quoted is per disc or drive.

Machine type by application

Combined Ledger/Stock/Invoicing

Machine type	Supplier name	Price	Capacity
ACT 800	ACT Microsoft	From £500	
ACT Sirius	ACT Microsoft	£495	
Apple II and III	Systematics	From £250	
Apple II	Vlasak Electronics Ltd	£855	1,500 a/c 5,000 trans
Apple II	Dataforce (U.K.) Ltd	£855	
Apple II	Microsense Computers Ltd	£340	
Apple II	Southern Computer Systems	£1,000	varies
Apple II/ITT	Informex London Ltd	£298	500 a/c
Apple II	Star Systems Ltd	£750	2,000 a/c 6,000 trans
Commodore	Comsoft Associates	£750	
Commodore 3032	Compfer Ltd	£400	varies
Commodore 3032	Analog Electronics	£550	
Commodore 3032	Logma Systems Designs	£600	1-6 shops
Commodore 3032	Grama (Winter) Ltd	£475	varies
Commodore 3032	Bristol Software Factory	£300	1,000 a/c 6,000 trans
Commodore 3032	Compfer Ltd	£600	500 a/c 1,000 items
Commodore 3032	HB Computers	£695	500 s/c 2,500 trans
CP/M	Sail	£1,265	varies
CP/M	Bonsai	£1,875	
CP/M	D T Systems	£750	varies
CP/M	Wisbech Computer Services	£900	varies
CP/M	Graffcom Systems Ltd	£400	varies
CP/M	Benchmark CS Ltd	£950	varies
CP/M	Computastore Ltd	£1,000	
CP/M	Interface Computer Services	£350	
CP/M	Minicomputer CS Ltd	£1,250	varies
CP/M	Salmon Microcomputing	£750	1,600 items 1,000 trans
CP/M	Selven Ltd	£1,500	3K a/c 7K trans
CP/M	Map Computer Systems	£1,000	varies
CP/M North Star	Instar Business Systems	£999	600-2,900
CP/M North Star	Criterion Business Systems		

SHOP WINDOW

RAM BARGAINS

4116 — 200ns.	80p each.
100 +	68p each.
4116 — 250ns.	70p each.
100 +	55p each.
2114 — 300ns.	85p each.
100 +	75p each.
2114 — L — 200ns.	95p each.
100 +	83p each.
4816 — 100ns. BBC RAM	£3.50 each.
4164 — 200ns.	£4.50 each.
100 +	£3.50 each.
6116 — 150ns.	£4.40 each.
2716 — 5v — 450ns.	£2.20 each.
2716 — 5v — unwashed	£1.80 each.
2732	£3.95 each.
2532	£3.95 each.
2764 — 450ns.	£9.00 each.

Add 50p P & P and VAT at 15%.

ATHANA FLOPPIES

Minis with free plastic library case and hub rings.	
S/S S/D.	£17.95 for 10.
S/S D/D.	£19.95 for 10.
D/S D/D.	£23.50 for 10.
S/S 77 TRACK.	£26.50 for 10.
8" Discs.	
S/S S/D.	£15.50 for 10.
S/S D/D.	£24.50 for 10.
D/S D/D.	£25.50 for 10.

All other discs available add 85p P & P and VAT at 15%.

OPUS DESKING

AT LAST COMPUTER FURNITURE MADE BY A COMPUTER COMPANY

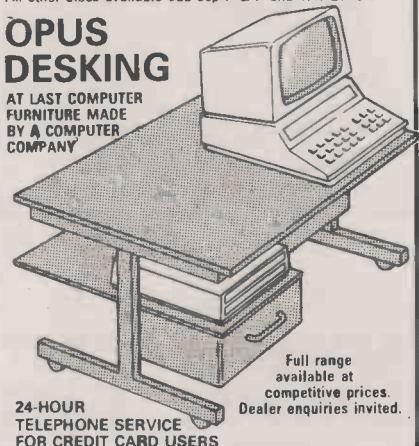

Full range available at competitive prices. Dealer enquiries invited.

24-HOUR TELEPHONE SERVICE FOR CREDIT CARD USERS

QUANTITY DISCOUNTS AVAILABLE — OFFICIAL ORDERS WELCOME

OPUS SUPPLIES



10 BECKENHAM GROVE, SHORTLANDS, KENT.



01-464 5040

● Circle No. 210

THE CP/M PROGRAMMER'S TOOLKIT

Featuring:

ASE allows you to access any sector on a CP/M disc, with facilities to view, modify and replace. Access to a particular sector is via the track and sector numbers.

AFE provides similar facilities as ASE but is orientated towards the logical records of any type of CP/M file.

And, included free of charge, with source code:

D a program which gives you a sorted wildcard directory list of every logged-on drive, with Read/Write status, free space, and number of directory entries.

CALLCPM an assembler routine which allows any CIS-COBOL program to call any CP/M function, and perform lower to upper-case translation.

Available on standard 8" discs. Including VAT, postage and packing. **£65**

ASRO

INFORMATION SYSTEMS
8A GUILDFORD ROAD,
BRIGHTON BN1 3LU Tel (0273) 21979

CP/M is a trademark of Digital Research
CIS-COBOL is a trademark of Microfocus

● Circle No. 211



COMPUTERCAT SOFTWARE

BBC MICRO DATABASE 1 £12.95
Set up your own database with search, sort facilities. About 300 records for 16K.

TREASURE ADVENTURE £6.95
Specially adapted for the BBC Micro — an old favourite.

VIDEO GENIE & TRS 80 FORTY NINER £5.95
Find the gold in sunny California.

BRIDGE BUILDER £5.95
A game of skill to bridge the gap.

TANK BATTLE £5.95
A game for two. Test your skills in battle.

● prices include VAT & Postage.

224 Chapel Street, Leigh, Lancs
Tel: (0942) 605730

● Circle No. 212

ASSEMBLY for PET LANGUAGE for VIC

PET from 8K: VIC 20 from 3.5K
Both books cover WHOLE 6502
Instruction set, AND CONTAIN

FULL 6502 ASSEMBLER

PRICES: 2/3/4000 PET & VIC BOOK £10
ALL PET & VIC: book + ASSEMBLER —
ON TAPE £15: ON DISK £17.

VIC BOOK CONTAINS M/C LANG MONITOR

SAE details from: DR P HOLMES (P)
21 Colin Drive
LONDON NW9 6ES
State Machine.

● Circle No. 213

AASP SYSTEMS LTD. TOTAL COMPUTER SERVICES TO BUSINESS

Eprom Programming and Copying

CP/M SOFTWARE

Multiple key file encryption £95+vat
Help system £95+vat
Superbrain fast disk copy £75+vat
Superbrain disk test £75+vat
++ Plus much more ++

P.O. Box 17
BURTON-ON-TRENT STAFFS

● Circle No. 214

North Star DOS	Intelligent Artefacts	£510	1,500 a/c 5K trans
Ohio Scientific	Microcomputer BM	£656	
Ohio Scientific	Stratheden Ltd		
Tandy Model 2	Chess Consultancies	£1,200	
Tandy Model 2	Chess Consultancies	£995	5,000 items 1,500 a/c
Tandy TRS-80	Microcomputer Applications	£90	
Tecs	Jar Software Systems	£650	500 a/c 300 nom. a/c

Database Managers

Machine type	Supplier name	Price	Capacity
Apple II	Spider	£200	2,800 records
Apple II	ACT Microsoft Ltd	£75	
Apple II	Courtman Micro Systems	£106	100K characters
Apple II	Keen Computers	£425	up to 70Mbytes
Apple II/ITT	Systematics International Ltd	£72	
Apple II/ITT	Diskdean Ltd	£120	varies
Apple II/ITT	Systematics International Ltd	£125	1,000 references
Apple II/ITT	Informex London Ltd	£198	500-1,200 records
Apple II/ITT	The Software House	£140	900 records
Commodore	Comsoft Associates	£250	
Commodore 3000/8	Stage One Computers	£45-£150	650-2,400 records
Commodore 3000/8	Commodore BM (U.K.) Ltd	£150-£300	650-1,400-64,000 records
Commodore 3032	CPS (Data Systems) Ltd	£200	varies
Commodore 3032/8	Compsoft Ltd	£190	600-5,000 records
CompuCorp	Verwood Systems	£376	
CP/M	Redwood	£120	
CP/M	Compsoft Ltd	£400	30,000 records
CP/M	Great Northern CS Ltd	£110-£210	and varies
CP/M	Microtek Computer Services	£250-£500	
CP/M	Cleno Computing Services	£90-£325	varies
CP/M	Interface Ltd	£200	varies
CP/M	Median-Tec Ltd	£500	
CP/M	Microbits	£145	varies
CP/M	Southdata Ltd	£650	up to 8Mbytes
CP/M SWTPC	Verwood Systems		
Metrotech System	Metrotech	£200-£1,000	
North Star	GW Computer	£575	
Ohio Challenger	U-Microcomputers Ltd	£175	
Ohio Scientific	Microcomputer BM	£175	
Superbrain	GW Computer	£575	
Superbrain	Alan Pearman Ltd	£295	varies
SWTPC	SWTPC	£100	
Tandy TRS-80	Clearstone ADP	£75	varies
Tandy TRS-80	ACT Microsoft Ltd	£75	
Z-80/8080	Structured Systems Group	£135	varies
Z-80/Cromenco	Xitan Systems Ltd	£850	4,000 records/disc

Engineering Design Systems

Machine type	Supplier name	Price	Notes
Apple II	Ismael CAD	varies	Range of building and engineering applications
Apple II	Gilmorehill Software	varies	Range of building and engineering applications
Apple II	Microcomp	From £200	Range of structural engineering applications
Apple II	Haden Young Ltd	From £50	Range of software for building/engineering
Apple II	James C Steadman	£200	Erect concrete columns
Apple II	James C Steadman	£250	Multibay frames
Apple II/ITT	Aerco-Gemsoft	£175	Pipeline engineering
Commodore	Ismael CAD	varies	Provide a range of software for building/engineering
Commodore	Comsoft Associates	£750	Engineering contractors estimates



Commodore 8000	The Computer Room	£1,500	Engineers production information control
Commodore 3032	Micro Computation	£300	Building-conversion specification
Commodore 3032	The Alphabet Co	£75	Time study and analysis
Commodore 3032	Comac Systems	£400	Asset register
Commodore 3032/8	Comac Systems	£400	Maintenance plan
Commodore 3032/8	Comac Systems	£400	Work orders
Commodore 3032/8	Comac Systems	£400	Plant history
Commodore 3032/8	Comac Systems	£400	Manpower analysis
CP/M	Ismael CAD	varies	Range of building and engineering applications
CP/M	Gilmorehill Software	varies	Range of building and engineering applications
CP/M	Hevacomp	£2,250	Heating and ventilation system design
CP/M	Hevacomp	£500	Building specification
CP/M	Hevacomp	£500	Building project cost control
CP/M	Median-Tec	£500	Plastic portal frames
CP/M	Median-Tec	£500	Slope-stability analysis
CP/M	Median-Tec	£500	Retaining wall design
Equinox	Equinox	£500	Civil/structural engineering design
Hewlett-Packard	CSC (Northern) Ltd	from £200	Engineering design systems
Superbrain	Stemmos	£2,500	Stress analysis for pipe networks
Superbrain	KGB	£2,500	Computer-aided design
Tandy TRS-80	Chess Consultancies	£450	Production planning
Tecs	Jar Software	£600	Production analysis

Estate Agents' Systems

Machine type	Supplier name	Price	Notes
Apple II	Atlanta	£750	
Apple II	Microsense	£500	
Apple II/ITT	Cyberpress	£650	
Apple II/ITT	Systematic	£850	
Commodore 3032	Stage Once Computers	£250	
Compucorp	Verwood systems	£700	Estate sales
Compucorp	Verwood systems	£1,200	Estate management
CP/M	Selven Ltd		Estate agents' sales and selection
Sharp MZ-80K	Wisbech Computer Services	£195	

Financial Systems

Machine type	Supplier name	Price	Notes
ACT 800	ACT Microsoft	£595	Micromodeller
ACT Sirius	ACT Microsoft	£150	SuperCalc
ACT Sirius	ACT Microsoft	£595	Micromodeller
Apple II	ACT Microsoft	£150	Micromodeller
Apple II	Personal Computers	£500	Income tax computations
Apple II and III	PE Consulting Group	£350	Microfinesse-financial planning
Apple II	Microdigital	£200	Sales analysis
Apple II	Microdigital	£130	Credit control
Apple II	Microsense	£194	Cashier retail/wholesale
Apple II	PK Microsystems		Solicitors' accounts
Apple II	Dataforce	£80	Cashflow projection
Apple II	Informex	£98	VAT system
Apple II	Southern Computer Systems	£750	Financial controller
Apple II/ITT	Microsense	£125	VisiCalc
Apple II/ITT	Systematics	£295	Financial planning

TRS80 Models I+III and VIDEO GENIE

ARE YOU PROGRAMMING IN A POLICE STATE?

Every time you run a BASIC program millions of innocent machine cycles get executed unnecessarily!

• **RED TAPE.** Every GOTO and GOSUB involves a meticulous search through the whole program for the target line.

• **BUREAUCRACY.** Every variable reference results in a thorough investigation of the system's dictionary.

• **PROTOCOL.** Who decides on the precedence of operators? The BASIC interpreter, of course.

• **DOGMA.** Each inoffensive constant has to undergo an indoctrination from decimal to binary each time it is used.

AND WHO SUFFERS? WHY YOU, THE CONSUMER, OF COURSE!

But you can stop this needless waste. A compiler sorts all this red tape out ONCE, before you run the program. The result? Speed-ups of 10, 20, even 30 times.

DO YOUR PROGRAMS A FAVOUR. GET A COMPILER.

ACCEL Level2 BASIC (tape) £19.95
ACCEL3 Full DISK BASIC (tape or disk) £49.95



PO Box 39, Eastleigh, Hants, SO5 5WQ

● Circle No. 215

**PC
SL**

PURLEY COMPUTER SYSTEMS LTD
 21 BARTHOLOMEW STREET
 NEWBURY, BERKS.
 Tel: (0635) 41784

STOCK TAKING CLEARANCE

● DISC DRIVE UNITS

SA 850 SHUGART 8", double sided, double density £400
 SA 800 SHUGART 8", single sided, double density £250
 FD 650 PERTEC 8", double sided, double density £250

● PRINTERS

MX 100 F/T EPSON 132 column, hi-res graphics £450
 150T ANACOM 132 column, 150 cps, 2k buffer £850
 DP8000* ANADEX 80 column, bi-directional, tractor feed £250
 RP1600 RICOH daisy-wheel £1395
 SHEET FEEDER for above £650

● TERMINALS AND DISPLAYS

TVI 920 TELEVIDEO rs 232 terminal £550
 TVI 912 C TELEVIDEO £475
 CROFTON 9" monitor £75

● \$100 RAM CARDS

STATIC RAM 32K £100 DYNAMIC RAM 64K £150
 16K £65 BUS TERMINATOR £10

● SOFTWARE

GRAFFCOM SUITE (1 set only) — £1200
 Sales — £300 NAD — £200 Payroll — £350
 Stock control — £275 Order entry and invoicing — £275
 ALL PRICES INC \$ SURCHARGES
 ALL ITEMS BRAND NEW — SHOWROOM STOCK EXCEPT (*) (EXCL C.P.I and VAT)

● Circle No. 216

SHOP WINDOW

**TANDY MODEL 1&3
TANDY COLOR and
VIDEO GENIE OWNERS**

NEW! From Cornsoft
Scarfman
WITH SOUND!!



America's latest Arcade craze. Its Eat or be Eaten. You control SCARFMAN around the maze, gobbling up everything in your path. You attempt to eat it all before the monsters devour you.

16K Cassette
includes V.A.T. & Postage
Available from your local dealer or

£11.95

MICRODEAL

DEAL HOUSE, BRIDGES, BODMIN
CORNWALL PL30 5EF TEL: 0726 850821
DEALER ENQUIRES WELCOME

● Circle No. 217

MICROCOMPUTER INSURANCE

Comprehensive cover at a reasonable premium:—

- All Risks Cover (incl. Transit) — up to £10,000 for £20
- Increased Cost of Working — to reinstate lost data
- Breakdown and Derangement — alternative to maintenance agreement

Write with details of equipment to:

Geoffrey Hoodless & Associates
Freepost (no stamp required)
Woking, Surrey GU21 3BR
Tel: Woking (04862) 61082 (24hrs)

● Circle No. 218

NOT

just another Apple bit copier

THROW AWAY YOUR LOCKSMITHI SNAPSHOT REMOVES COPY PROTECTION, AND COPIES PROGRAMS THAT NO BIT COPIER CAN TOUCH — INCLUDING THE BIT COPIERS THEMSELVES!

SNAPSHOT will copy any program, in any language or DOS, that runs on a 48K Apple II (except programs that use a Z-80 card or that repeatedly access their own disk while running.) SNAPSHOT is a peripheral card that uses your Language Card to interrupt a running program and dump the entire contents of 48K and registers to an unprotected 16-sector backup disk. Unlike bit copiers, SNAPSHOT requires no parameter changes or trial-and-error tedium. SNAPSHOT's full monitor facilities make it ideal for debugging your own programs or analysing others' programs. PRICE £95 (inclusive).

ARK ALAR SYSTEMS

54 ROBIN HOOD WAY, GREENFORD, MIDD.
PH. 01-900 0104

● Circle No. 219

Apple II/ITT	Systematics	£1,000	Financial controller
Apple II/ITT	Microsense	£75	Modelling desktop plan
Commodore 3000	Stage One Computers	£250	Financial accounts package
Commodore 3000/8	ACT Microsoft	£125	Financial modelling
Commodore 3032	Stage One Computers	£100	Quote processing
Commodore 3032	CPS	£575	Invoice-costing/jewellers
Commodore 3032	L & J Computers	£90	Cash book
Commodore 3032	ACT (Petsoft)	£150	Financial planning
Commodore 3032	Stage One Computers	£100	Bank a/c reconcile
Commodore 3032	Logma Systems	£600	Sales/analysis
Commodore 8000	ACT Microsoft	£595	Micromodeller
CP/M	Great Northern	£299	Minimodel
CP/M	Omicron	POA	Dual currency sales and bought-ledger systems
CP/M	Bytesoft	£95	Financial modelling
CP/M	Micromedia	£1,000	Invoice disc factoring
CP/M	Graffcom System	£400	Hire-purchase system
CP/M	MAP Computers	£550	Financing system
CP/M	Microtek	£500	Accounting
CP/M	Microtek	£750	Budget control
CP/M	Median-Tec	£500	Financial analysis
CP/M	Graffcom Systems	£450	Purchasing system
CP/M	Business Solutions	£395	Mars
Durango F-85	Kesho Systems	£1,000	Time recording/ledger
IBM PC	ACT Microsoft	£595	Micromodeller
Superbrain	Alan Pearman Ltd	£315	Financial planning
Tandy TRS-80	Chess Consultancies	£800	Sales statistics
Tandy TRS-80	A J Harding	£125	Financial balancing
Z-80/8080	Intereurope	£500	Financial modelling
Z-80/8080	Graham Dorian	£325	Sales analysis retail

General Ledger

Machine type	Supplier name	Price	Capacity
Apple II and III	Systematics	£250	
Apple II	Computer Systems	£295	500 a/c 1,700 trans
Apple II	Dataforce (U.K.) Ltd	£225	200 a/c 1,000 trans
Apple	Style Systems Ltd	£250	1,000 a/c, 2,000 postings
Apple II	Southern Computer Systems	£750	1,000 a/c 12 branches
Apple II/ITT	Systematics International Ltd		
Apple II/ITT	Guestel Ltd	£300	200 a/c
Commodore	Comsoft Associates	£350	
Commodore 3032	Bristol Software Factory	£300	1,000 a/c 6,000 trans
Commodore 3032	Analog Electronics	£450	
Commodore 8000	Commodore BM (U.K.) Ltd	£300	600 a/c 3,000 trans
Compucorp	Verwood Systems	£250	
CP/M	Sail	£390	varies
CP/M	Wisbech Computer Services	£300	
CP/M	Business Solutions Ltd	£390	varies
CP/M	Bytesoft	£690	varies
CP/M	PR Daly & Co Ltd	£500	
CP/M	Haywood Associates Ltd	£500	
CP/M	Median-Tec Ltd	£500	500 a/c 5,000 trans
CP/M	Ludhouse Ltd	£500	200 a/c 5,000 trans
CP/M	Computastore Ltd	£500	999 a/c 99 centres nine computers
CP/M	Great Northern CS	£345	250 a/c
CP/M	Selven Ltd	£400	1,000 a/c 3,000 trans
CP/M	Interface Computer Services	£350	varies
CP/M	Microbits Ltd	£500	varies
CP/M	Map Computer Systems	£300	250 a/c 3,500 + trans
CP/M	Benchmark CS Ltd	£250	150 a/c 500 trans
CP/M North Star	Claisse/Allen Computing	£500	999 a/c 99 entries, nine computers
Horizon			



North Star DOS	Intelligent Artefacts Ltd	£295	1,500 a/c 5,000 trans
Ohio Scientific	Stratheden Ltd	£500	varies
Tandy Model 2	Chess Consultancies Ltd	£400	1,000 a/c
Tandy TRS-80	Tridata Micros Ltd	£225	500 a/c 1,800 trans
Z-80	Liveport Ltd		
Z80/8080	Solitaire	£500	Up to 26 by 400 a/c
Zilog MCZ range	Microbits	£500	100 a/c 5,000 trans

Hotel and Travel Packages

Machine type	Supplier name	Price	Notes
Apple II	Dataforce	£525	Hotel management
Apple II	Informex Logic	£298	Travel agents' system
Apple II	Informex Logic	£298	Hotel administration system
Apple II/ITT	Guestel Ltd	£500	Hotel billing
Apple II	Diskwise Ltd	£695	Hotel reservation and guest billing
Commodore 3000	Landsler Software	£350	Hotel guest billing
CP/M	Sail	£600	Bar and food stock
CP/M	Sail	£1,200	Stock and accounting

Incomplete Records

Machine type	Supplier name	Price	Capacity
Apple II/ITT	Padmede Computer Services	£450	900 a/c 2,000 trans/disc
Apple II	Keen Computers	£580	up to 70Mbytes
Apple II	Southern Computer Systems	£750	500 a/c 2,000 trans
Commodore	The Computer Room	£230	
Commodore 3032	Stage One Computers	£750	500 centres 2,300 a/c
Commodore 3032	Micro Computation	£555	120 a/c 5,000 trans
CP/M	Map	£1,250	
CP/M	Wisbech Computer Services	£750	
CP/M	CPL Ltd		250 headings, 2,000 trans per 5.25 disc
CP/M	Benchmark Ltd	£975	
CP/M	Bytesoft	£250	3,000 trans
CP/M	Criterion Business Systems	£375	2,500 entries
CP/M	Ludhouse Ltd	£1,000	variable
CP/M	Salmon Microcomputing	£950	5,000 entries
CP/M	Map Computer Systems	£550	
Durango F-85	Kesho Systems	£1,000	
Exidy Sorcerer	Basic Computing	£350	See also Micropute
Tandy Model I	A J Harding (Molimerx)	£150	1,200
Tandy Model I	Quicknet	£785	300 a/c 2,000 trans
Tandy Model II	IBIS Business Info Systems		9,000 a/c codes

Job Costing/Billing

Machine type	Supplier name	Price	Capacity
Apple II	Informex London	£498	1,000 emp-pro-exp codes
Apple II	Deltic Computing Ltd	£250	
Apple II	Southern Computer Systems	£750	
Apple II/ITT	Padmere Computer Services	£300	999 clients 99 rates
Apple II/ITT	TABS Ltd	£99	100 jobs 3,000 trans
Commodore	Comsoft Associates	£350	
Commodore 3032	CSM Ltd	£600	1,000 jobs 100 people
Commodore 3032	Stage One Computers	£100	300 appointments
CP/M	Bromley	£400	
CP/M	Vauntberry	£1,450	
CP/M	Business Solutions Ltd	£190	varies
CP/M	Map Computer Systems Ltd	£550	400-96,000 jobs
CP/M	Graffcom Systems Ltd	£400	varies
CP/M	Ludhouse Ltd	£1,000	1,000 jobs 35 codes
CP/M	Microtek Computer Services	£1,000	
CP/M	Great Northern CS Ltd	£455	300 clients
CP/M	Salmon Microcomputing	£300	225 codes
CP/M	CPL Ltd	£300	
CP/M	Goldcrest	£200	
CP/M North Star	Intelligent Artefacts	£275	

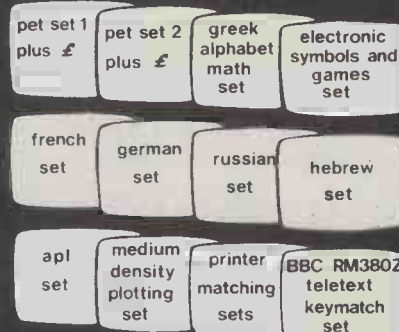

4 DIFFERENT SETS OF CHARACTERS ON SCREEN TOGETHER

FOR 2-3-4-8000 PET/CBM COMPUTERS

ALPHA PLUS

Avon Computer Rentals

FREEPOST 3 THORNBURY BRISTOL, BS12 1BR
TELEPHONE (0454) 415460

● Circle No. 220

supercharge your SUPERBRAIN

- * Speed up disk operations by 400%
- * Cut copying time by up to 75%
- * Copy screens to memory or printer
- * Chain COM files from BASIC
- * Get BDOS errors under your control
- * Write unbreakable security routines
- * Autoboot any program
- * Customise your favourite Word-processor

SeeDee Software tune up kits start at £30.00



Full details from:

COMPUTER FACILITY

0734 867855

32 Redlands Road, READING, Berks.

● Circle No. 221



ASHFORD COMPUTER CENTRE

Most makes of Micros and Accessories supplied. Courses in Computer Programming for the Complete Novice. Free Computer Club most Sundays 10 am - 3 pm. Micro Hospital £25.00 + parts repairs most Micros.

NO REPAIR - NO CHARGE

Ring for Details
ASHFORD 44955

● Circle No. 222

SHOP WINDOW

**B B C
UPGRADES**
LOW PRICES
16K RAM <£30
Dealers Welcome

Avon Computer Rentals
FREEPOST ■ THORNBURY BRISTOL BS12 1BR
TELEPHONE (0454) 415460

● Circle No. 223

BRAIN SURGEON

Anita Electronic Services (London) Ltd are specialists in the repair and service of Superbrain I and II and associated printers including Apple silent type, Centronic, Anadex, NEC, QUME, Ricoh and Empson.

We also specialise in the repair of Commodore and Apple computers.

We offer a fast on-sight service or alternatively repairs can be carried out at our workshops should you wish to bring in your machine.

Maintenance contracts are available at very competitive prices. Trade enquiries welcome.

For further information telephone or write to:

MR D. WILKINSON
Anita Electronic Services Ltd.,
15 Clerkenwell Close,
London E.C.1.
01-253 2444

● Circle No. 224

LOW COST HIGH QUALITY SOFTWARE FOR 32K COMMODORE PET

PURCHASE & SALES CONTROL £80 + VAT
Including new datesort routine. Runs both purchase and sales ledgers to provide a chronological list of receipts and/or payments. VAT calculation from either the net or the gross amount (e.g. on petrol receipts) or VAT amount keyed in. Provides due for payment report at any time and purchase or sales analysis for any period with totals for net, VAT, gross and 99 analysis codes.

INVOICE PRINT £80 + VAT
An add-on for PURCHASE & SALES CONTROL to print invoices laid out according to your own instructions, which you key in on the first run.

STOCK CONTROL £60 + VAT
Stock lists with purchase and selling valuations, re-order list and list of goods needing re-ordering.

NOMINAL LEDGER £60 + VAT
Trial balance, profit & loss, balance sheet and 20 other reports from 1000 nominal accounts.

ADDRESSES £60 + VAT
Select addresses by categories from your mailing list and print labels in pairs. (Labels also available).

Don't be put off by the low prices! Write or phone for details:

Electronic Aids (Tewkesbury) Ltd., Mythe Crest, The Mythe, Tewkesbury, Glos. GL20 6EB.
Tel. (0386) 831020 or (0 84) 294003

Mailing Systems

Machine type	Supplier name	Price	Capacity
Apple II	Keen Computers Ltd	£300	500 addresses
Apple II	SBD Consultants Ltd	£55	
Apple II	Microsense Computers Ltd	£70	
Apple II	Informex London Ltd	£198	
Apple II	Atlanta	£55	1,000 names and addresses
Apple II	Keen Computers	£495	32,767 records
Apple II/ITT	Systematics International Ltd	£300	500 addresses
Apple II/ITT	The Software House	£57	750 names and addresses
Apple II/ITT	Personal Computers Ltd	£50	400 entries
Commodore	Comsoft Associates	£150	
Commodore 3000/8	Amplicon MS Ltd	£145	1,500-4,000 records
Commodore 3032	MMS Computer Systems	£250	3,000 records
Commodore 3032	Stage One Computers	£100	325 records
Commodore 3032/8	Compsoft Ltd	£190	13,000
Compucorp	Verwood Systems	£250	
CP/M	Bromley	£400	
CP/M	Sail	£100	varies
CP/M	Goldcrest	£200	
CP/M	Compsoft Ltd	£400	27,000
CP/M	Structured Systems Group	£50	varies
CP/M	Graffcom Systems Ltd	£250	800-5,000 records
CP/M	Median-Tec Ltd	£500	
CP/M	Microbits	£230	varies
CP/M	Interface Computer Services	£200	varies
CP/M Horizon	Microtek Computer Services	£250	varies
CP/M North Star	Intelligent Artifacts	£250	
CP/M North Star	Micromedia Systems	£195	
CP/M Vector	Taylor Microsystems	£395	
North Star	Intelligent Artifacts	250	
North Star Horizon	Wisbech Computer Services	£195	1,200 per disc
Tandy TRS-80	AA J Harding (Molimerx)	£55	600-3,750 records
Tandy TRS-80	Comput-A-Crop	£78	varies
Z-80/8080	Intereurope SD Ltd	£200	30,000 entries
Z-80/8080	Micro Focus	£90	varies

Nominal Ledger

Machine type	Supplier name	Price	Capacity
Apple II	Logic Computers	£630	100 depts, 200 a/c
Apple III	Logic Computers	£630	500 depts, 500 a/c
CP/M	Map	£400	999 headings
CP/M	Bonsai	£475	999 headings
CP/M	Bromley	£400	
CP/M	P R Daly	£500	
CP/M	Vauntberry	£950	
CP/M	D T Systems	£750	

Order Entry/Invoicing

Machine type	Supplier name	Price	Notes
Apple II and III	Systematics	£250	Invoicing
Apple II	Informex	£198	Invoicing system
Apple II	Southern Computer Systems	£750	Invoicing
Commodore 3032	MMS Computers	£250	Order control
Compucorp	Verwood Systems	£250	
CP/M	Sail	£250	Invoicing/back orders
CP/M	Bromley	£400	Order processing
CP/M	P R Daly	£350	Invoicing
CP/M	Vauntberry	£950	Order processing
CP/M	Typestyle	£250	Invoicing
CP/M	Wisbech Computer Services	£600	
CP/M	Graham-Dorian	£500	200 invoices 1,500
CP/M	Goldcrest	£300	Invoicing
CP/M	P R Daly & Co	£200	Invoicing



CP/M	Graffcom Systems	£350	Order entry/invoicing
CP/M	Interface Ltd	£250	Invoicing
CP/M	Median-Tec		Invoicing
Tandy TRS-80	Tridata Micros	£75	Invoicing
Z-80/MCZ	Software Architects	£600	Order entry/invoicing

Payroll

Machine type	Supplier name	Price	Capacity
Apple II	Logic Computers	£630	300 personnel
Apple III	Logic Computers	£630	1,000 personnel
Apple II and III	Systematics	£250	
Apple II	Dataforce (U.K.) Ltd	£375	
Apple II/ITT	TW Computers Ltd	£145	
Apple II/ITT	Informex London Ltd	£298	
Apple II/ITT	Algobel Computers	£295	500 employees
Apple II/ITT	Vlasak Electronics Ltd	£375	200 employees
Apple II/ITT	Computech Systems	£379	300 employees
Apple	Style Systems Ltd	£350	450 employees
Apple II/ITT	Tabz Ltd	£99	50 weekly 100 monthly
Commodore	Comsoft Associates	£350	500 employees
Commodore 3000/8	Commodore BM (U.K.) Ltd	£150	200-600 employees
Commodore 3000/8	Landsler Software	£150	200-500 employees
Commodore 3032	Analog Electronics	£90	
Commodore 3032	L & J Computers	£220	
Commodore 3032	Intex Datalog Ltd	£195	200 employees
Commodore 3032	Computastore Ltd	£75	483 employees
Commodore 3032	ACT (Petsoft) Ltd	£195	600 employees
CP/M	Map	£550	5,000 employees
CP/M	Bromley	£400	
CP/M	P R Daly	£350	
CP/M	Vauntberry	£950	
CP/M	Benchmark CS Ltd	£350	300 employees, 50 departments
CP/M	Haywood Associates Ltd	£350	
CP/M	Median-Tec	£500	1,000 employees
CP/M	Salmon-Microcomputing	£300	500 employees
CP/M	Map Computer Systems	£350	300-96,000 employees
CP/M	Daman Computer Services	£900	1,000 employees/Byte
CP/M	Selven Ltd	£500	400 employees
CP/M	P R Daly & Co Ltd	£350	
CP/M	Graffcom Systems Ltd	£500	500 employees
CP/M	Horizon Software Ltd	£500	
CP/M	PCL Software Ltd	£495	1,200 employees
CP/M	Ludhouse Ltd	£450	300 employees
CP/M	Comput-A-Crop	£495	175 employees
CP/M	Microbits	£500	Varies
CP/M North Star	Micromedia Systems	£495	350 employees
CP/M North Star	Intelligent Artefacts	£52	100 employees
CP/M Vector	Taylor Micro Systems	£490	
Durango F-85	Kesho Systems	£500	
Horizon	Claissie-Allen Computing	£500	250 employees
Ohio Scientific	Stratheden Ltd	£750	varies
Sharp MZ-80	Tridata Micros Ltd	£250	400 employees
Tandy TRS-80	A J Harding (Molimerx)	£120	
Tandy TRS-80	Chess Consultancies	£400	400 employees
Tandy TRS-80	FIBS	£429	
Tandy Model 2	P J Norris	£500	1,000 per disk
Tandy TRS-80	Tridata Micros Ltd	£218	400 employees
Tandy TRS-80	3-line Computing	£140	
Tecs	Jar Software Systems	£250	300 employees
Z-80/8080	Liveport Ltd	£250	500 employees
Z-80/8080	Solitaire	£500	200 employees
Zilog MCZ range	Microbits	£500	300 employees

"CALC" Power!

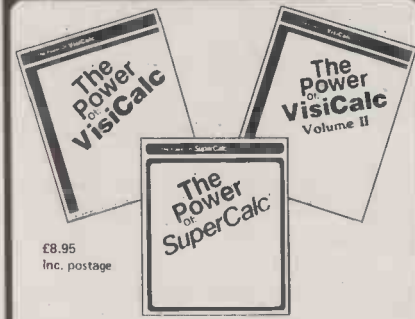

Written in plain English, each of these texts contain seven easy-to-follow exercises, especially designed to show users of these popular computer software programs how to expand their applications usage. Specific examples are used to illustrate the logic of each step in designing an applications program.

All the reader has to do is follow step-by-step instructions in the text to acquire an understanding of the basic concepts behind function and command users, and the ability to apply them to their own specific problems.

IF YOU OWN OR ARE THINKING OF BUYING VISICALC OR SUPERCALC, YOU SHOULD OWN THIS BOOK!!

PCP
PROTOCOL COMPUTER PRODUCTS

Apartment 3
114 Wealdmore Road
Bromley, Kent BR1 3BE

Phone: 01-460 2580

● Circle No. 226

OSBORNE 1

IN BUCKINGHAMSHIRE

WE DEMO AND DELIVER TODAY

0295.66555

4B

COMPUTER SERVICES

● Circle No. 227

HISOFT PASCAL 4

Incredible Speed, Incredible Price!

Hisoft announces a new, disk-based Pascal compiler which is available for Z80 CP/M systems.*

The compiler produces Z80 object code directly, no P-codes, and this code executes faster than that produced by any other currently available micro-computer Pascal compiler.

All the major features of the Pascal language are supported including RECORDS, POINTERS and FILES (of CHAR).

Hisoft's policy is to continuously extend the capabilities of its software and further versions of the compiler will be supplied to purchasers of the current version at a minimal cost. Extensions to FILE handling will be available soon.

Hisoft Pascal 4 is a powerful and reliable piece of software and yet it requires only a 32K system in which to run and costs:

an incredible £40!

*Currently available for SUPERBRAIN, RML380Z, NASCOMs & GEMINI.

Hisoft also have available:

Hisoft Pascal 3	tape-based pascal compiler for NASCOM & SHARP MZ80K	£35
ZDEV	a Z80 Development System for GEMINI (G805 or G809) disk system	£45
NASMDN	a 4K NASCOM monitor	£25
NASGEN	assembler under NASMDN	£15
NASNEM	disassembler under NASMDN	£10
BAS12K	12K BASIC interpreter under NASMDN	£20

All prices are fully inclusive.

Full details from:

HISOFT

60 Hallam Moor, Liden,
Swindon, SN3 6LS.
Tel. 0793 26616 ansaphone.

● Circle No. 228

UK101 COMPUTERCASES SUPER'D NASCOM TANGERINE BIGBOARD MANY MANY OTHERS

Expansion problems eliminated, all your expansion boards, power supplies etc., neatly housed in one steel black textured case. The case is pre-cut for TWO 5 1/4" disc drives, (please enquire for 8" drives) keyboard panel is also pre-cut.

CASE SIZE approx 24" deep, 21" wide, 8 1/2" high at the rear. The sloped front panel and lid is hinged and removable for easy access.
MODEL A ... STANDARD UK101 keyboard + Two disc drive cutout.
MODEL B ... As above plus power bulge to accom. Audib Computers memory expansion module.
Please enquire for other keyboard options available, or for further information enclosing s.a.e.

MODEL A ... £75.00 MODEL B ... £77.00

DRIVES

To fit above case or your own enclosure.

EXCEPTIONAL value famous make drives with solenoid operated head to minimise unnecessary head contact saving wear on head and disc. Drives are 40 Track single sided (can be used in double density mode if req.)
Drives COMPATIBLE UK101 Super'd, Nascom, Genie, Tandy Atom, B.B.C. etc.

5 1/4" S.S. ... £139.00 Dual 5 1/4" S.S. ... £275.00
or with power supply
Single 5 1/4" S.S. with power supply £175. Dual 5 1/4" S.S. with power sup. £320.00

SPECIAL OFFER

Deduct £5.00 from order if ONE drive + computer case ordered together.
Deduct £10.00 if TWO drives + computer case ordered together.

DISCS

5 1/4" S.S.S.D. ... IX = £1.89, 10 X 5 1/4" S.S.S.D. ... £17.50 with free library case.

TERMS ... Please add VAT @ 15% to above prices.
NOTE ... Post/pack on computer case free. Post on disc drives £10.00/order.
Discs £1.00/order.
Send cheques P.O. to.

SILENT COMPUTERS Ltd.

27 WYCOMBE Rd., LONDON N.17 9XN. Tel: 01-801 3014

MAIL ORDER ONLY viewing and collection can be arranged at weekends by appointment only.
Good UK101 arcade type or other programs wanted, especially with sound, standard or 32 x 48 format.

UK101 COMPUTERCASES SUPER'D NASCOM TANGERINE BIGBOARD MANY MANY OTHERS

● Circle No. 229

THE POWER BANK

Plug your micro computer video unit and Printer into the POWER BANK and forget about a disabling break in the electricity supply. This unit will continue to run your system in the event of a mains failure ... WITH NO INTERRUPTION TO YOUR WORK!



Batteries included

Vital when running business systems. This unit will of course suppress MAINS SPIKES and SURGES.

SINEWAVE OUTPUT

120VA £320 250VA £450

plus carriage, packing and VAT

POWER TESTING LTD

137a High Street, Brentwood, Essex CH14 4RX

Tel: Brentwood (0277) 220617

● Circle No. 230

* BIG EARS *

SPEECH INPUT FOR ANY COMPUTER



Hugely successful Speech Recognition System, complete with microphone, software and full instructions.

BUILT TESTED & GUARANTEED ONLY £49

PLEASE STATE COMPUTER: UK101, SUPERBOARD, NASCOM2, Vic 20, Micron, BBC Micro ZX80/81, PET, TRS80, M280K, APPLE II

ZX80 ZX81

MUSIC SYNTHESISER + 16 LINE CONTROL PORT

Play 3-part music, sound effects, drums etc. Full control of attack, decay and frequency. Input/Output lines provide control and monitor facility for Home Security, Robot Control, Model Railway, etc. etc. Works with or without 16K RAM.

Add keyboard to make a live performance polyphonic synthesiser! Full instructions/software included.

AMAZING VALUE AT ONLY £19.50 (KIT)

Extra Connector at £2.50 £25.50 (BUILT)

COLOUR MODULATOR KIT £12 BUILT £18

RGB In, PAL/UF out

UK101/NASCOM COLOUR GRAPHICS KIT £45 BUILT £60

(Inc. Modulator. Still the best selling system!)

Please add VAT at 15% to all prices.

Barclay/Access orders accepted by telephone

WILLIAM STUART SYSTEMS Ltd

Dower House, Billericay Road, Herongate, Brentwood, Essex CM13 3SD

Telephone: Brentwood (0277) 810244

● Circle No. 231

Personnel and Administration

Machine type	Supplier name	Price	Application
Apple II	Informex Logic	£198	Personnel records
Apple II	Informex Logic	£298	Staff selection tests
Apple II/ITT	Informex Logic	£298	Employment agency system
Apple II/ITT	Informex Logic	£198	Medical records
Apple II/ITT	Informex Logic	£198	Hospital administration
Commodore 3000	Intext Datalog Ltd	£100	Hospital administration
Commodore 8096	Missing Link	£2,000	Personnel records
Compucorp	Verwood Systems	£250	
CP/M	MJN Consulting	£2,000	Integrated personnel records and payroll
CP/M	Median-Tec Ltd	£1,500	Employment agency system
CP/M North Star	Micromedia	£595	Personnel records
CP/M Vector	Taylor Microsystems	£500	Piece work
Superbrain	Micro-Pension	£950	Pensions administration
Z-80/8080	Intereurope	£500	Personnel records

Property Management

Machine type	Supplier name	Price	Capacity
Apple II/ITT	Cyderpress Ltd	£650	
Apple II/ITT	Informex London Ltd	£298	300 entries
Apple II/ITT	Cyderpress Ltd	£650	500 properties
Apple II/ITT	Algobel Computers Ltd	£650	400 properties
Commodore 3032/8	Compsoft Ltd	£190	13,000
CP/M	Compsoft Ltd	£400	27,000
CP/M	Algobel Computers Ltd	£650	2,000 trans
CP/M	Salmon Microcomputing	£900	
Z-80/8080	Graham Dorian Software	£325	varies

Purchase Ledger

Machine Type	Supplier name	Price	Capacity
Apple II	Logic Computers	£630	800 a/c, 1,500 trans
Apple III	Logic Computers	£630	2,000 a/c, 5,000 trans
Apple II and III	Systematics	£250	
Apple II	Dataforce (U.K.) Ltd	£315	200 a/c, 1,000 trans
Apple II	Logic Box Ltd	£490	400 a/c, 1,000 trans
Apple II	Deltic Computing Ltd	£250	1,000 trans
Apple II	Computech Systems	£295	500 a/c, 1,600 trans
Apple II	Southern Computer Systems	£750	variable
Apple II/ITT	Systematics International Ltd		
Apple II/ITT	Padmede Computer Services	£300	900 a/c, 4,500 trans/disc
Apple	Style Systems Ltd	£250	650 a/c, 1,750 trans
Apple II/ITT	Guestel Ltd	£300	200 a/c
Commodore	Comsoft Associates	£350	1,000 a/c
Commodore 3000/8	CSM Ltd	£550	1,000-2,000 a/c 6,000-10,000 trans
Commodore 3000/8	Anagram Systems	£399	30200-2,000 a/c 800-16,000 trans
Commodore 3032	ACT (Petsoft) Ltd	£120	200 a/c 700 trans
Commodore 3032	Compfer Ltd	£300	1,000 trans 7,000 entries
Commodore 8000	Commodore BM Ltd	£300	600 a/c 4,500 trans
Compucorp	Verwood Systems	£250	
CP/M	Sail	£395	varies
CP/M	Bonsai	£475	
CP/M	Bromley	£400	
CP/M	P R Daly	£350	
CP/M	Vauntberry	£950	
CP/M	Typestyle	£250	
CP/M	Johnson	£200	
CP/M	DT Systems	£750	
CP/M	CPL Ltd	£300	
CP/M	Goldcrest	£300	



CP/M	Wisbech Computer Services	£300	
CP/M	Bytesoft	£400	varies
CP/M	Business Solutions Ltd	£390	varies
CP/M	Median-Tec Ltd	£500	500 a/c 5,000 trans
CP/M	Ludhouse Ltd	£500	500 a/c 5,000 trans
CP/M	Great Northern CS Ltd	£315	500 a/c
CP/M	Structured Systems Ltd	£460	varies
CP/M	Selven Ltd	£600	1,000 a/c
			2,000 trans
CP/M	Salmon Microcomputing	£350	1,000 a/c
			24,000 trans
CP/M	Map Computer Systems Ltd	£400	400-96,000 a/c
CP/M	Microbits	£500	varies
CP/M	PR Daly & Co Ltd	£350	
CP/M	Computastore Ltd	£400	500 a/c 3,100 trans
CP/M	Haywood Associates	£350	
CP/M	Interface Computer Services	£350	varies
CP/M	Selven Systems	£600	500 suppliers 5,000 trans
CP/M North Star	Benchmark CS Ltd	£250	100 a/c 300 trans
Durango F-85	Kesho Systems	£500	
Exidy Sorcerer	Basic Computing	£125	See also Micropute
Horizon	Claisse Allen Computing	£500	800 a/c 2,000 trans
Ohio Scientific	Stratheden Ltd	£500	varies
Tandy Models 1&2	Chess Consultancies Ltd	£250	300-500 a/c
Tandy TRS-80	FIBS	£750	part of integrated system
Tandy TRS-80	Tridata Micros Ltd	£225	125 a/c 1,000 trans
Zilog MCZ range	Microbits Ltd	£500	400 suppliers 1,000 trans
Z-80	Liveport Ltd		
Z80-8080	Solitaire	£500	200 by 26 a/c

Sales Ledger

Machine type	Supplier name	Price	Capacity
Apple II		£630	600 a/c, 1,500 trans
Apple III	Logic Computers	£630	2,000 a/c, 5,000 trans
Apple II and III	Systematics	£250	
Apple II	Computech Systems	£295	500 a/c 1,600 trans
Apple II	Dataforce (U.K.) Ltd	£315	200 a/c 1,000 trans
Apple II	Logic Box Ltd	£490	300 a/c 1,300 trans
Apple II	Deltic Computing Ltd	£250	1,000 a/c
Apple II/ITT	Padmede Computer Services	£300	900 a/c 4,500 trans/disc
Apple II/ITT	Guestel Ltd	£300	200 a/c
Apple II/ITT	Systematics International Ltd		
Apple II	Southern Computer Systems	£750	
Apple	Style Systems Ltd	£250	650 a/c 2,500 trans
Commodore	Comsoft Associates	£350	
Commodore 3000/8	Anagram Systems	£299	250-2,000 a/c
			500-10,000 trans
Commodore 3000/8	CSM Ltd	£550 and £650	1,000-2,000 a/c
			6,000-10,000 trans
Commodore 3032	ACT (Petsoft) Ltd	£120	200 a/c 700 trans
Commodore 8000	Commodore BM (U.K.) Ltd	£300	600 a/c 4,500 trans
Compucorp	Verwood Systems	£250	
CP/M	Map	£400	
CP/M	Bonsai	£475	
CP/M	Bromley	£400	
CP/M	P R Daly	£350	
CP/M	Vauntberry	£950	
CP/M	Typestyle	£250	
CP/M	Johnson	£200	
CP/M	Wisbech Computer Services	£300	
CP/M	Goldcrest	£300	
CP/M	CPL Ltd	£300	with invoices
CP/M	Business Solutions	£425	
CP/M	Bytesoft	£400	varies
CP/M	PCL Software Ltd	£475	950 a/c
CP/M	Great Northern CS Ltd	£415	500 a/c



One day: 10am to 6pm.
August 21st. Westminster Exhibition Centre
(Royal Horticultural Society New Hall)
Greycoat Street, London SW1.

Nearest Tube: Victoria or St James' Park.

Admission: Adult 50p; Child (under 14) 30p. From
Mike Johnston, 71 Park Lane, London N17 0HG (Enclose S.A.E.).

● Circle No. 232



Calling all hobbyists, schools, software houses and budding programmers!

We would like to hear from program writers who would like to see their work published on Prestel for everyone to use. We'd like programs for most micros — Apple, BBC, Commodore, Tandy, Sinclair to be included in our Database, Aladdin's Cave.

If you are interested then please contact us at:

Aladdin's Cave, Prestel Headquarters, Telephone House, Temple Ave, London EC47 0HL.

Prestel and the Prestel symbol are trademarks of British Telecommunications.

● Circle No. 233



POLYGON I
S100 High Resolution Graphics

Features:

IEEE 696 512 x 512 graphics
Latest dedicated controller for high speed operation and ease of use.

512 diagonal can be drawn in 700 us.
Can display 85 x 57 characters using built in character generator.

Characters may be:

straight or tilted
written in any of four directions
characters may be scaled by a factor of 1 to 16 (Independently for X and Y)

IO mapped controller does not take up user memory space.

Light pen facility.

PCB & documentation

£29.95

Built and tested

£180

Add on colour board — to follow soon

£90

Please add £1.50 p&p and 15% VAT

DATA SYSTEMS CONSULTANTS, 43 SIMONBURN AVE., FENHAM, NEWCASTLE UPON TYNE, NE4 9UA

0632-741723 evenings and weekends.

● Circle No. 234

MICROWARE

(London Ltd)

COMPLETE DISC DRIVE SUB SYSTEMS

For Tandy; Video Genie;
Nascom

AND ALL POPULAR MICROS

SINGLE UNITS **£175**

DUAL UNITS **£295**

BBC MICRO

SINGLE UNIT FROM £135

Includes PSU and attractive desk top cabinet

- Fully guaranteed CDC disc drives
- Cast aluminium chassis
- 5 mili sec track to track
- 250k; 500k or 1MB
- Industry compatible

Microware

(London Ltd)
637 Holloway Road,
London N19
Tel: 01-272 6237
01-272 6398

● Circle No. 235

:DISCS FORTH;

Complete DIY FORTH kit
1) Installation manual £10
How to do it + definitions + editor.
2) Source code listing for one processor £10
6502, 6800, 6809, 8080/280, 8086/8088, 9900, 1802
manual + one listing £19
Ready to run
FORTH on disc for most machines incl. PET, TRS80,
FLEX, CP/M, IBM, and more from £50
Dual 8" disc drives £525 + VAT
2 x 8" single-sided double-density Shugart drives
+ box + PSU + intelligent controller
SAE for details including FORTH books



MicroProcessor Engineering Ltd
21 Hanley Road Shirley
Southampton SO1 5AP
Tel: Southampton 775482

● Circle No. 236

"TERMINUS" VDUs

RS232, 11 speeds 75 to 38400 baud. Green matt
screen. 25 x 80 with status line. ASCII (true
decoders) plus graphics, 190 displayable charac-
ters; 6 x 8 matrix in 8 x 11 box, full box avail-
able to graphics; alter matrix any character.
Reverse video, dual intensity, flashing & under-
lining, any combination, character by character;
selective erasure. Protected spaces. Detached key-
board with sidepad. Full cursor control including
addressing & read position. On & off line editing.
Scroll & page. 20 strings up to 511 characters
storable & recallable from keyboard & line.
Optional 2nd page memory improves editing, allows
animation.
Optional printer port.

"Terminus" VDU : £540-00
2nd page memory: add £ 24-00
Printer port : add £ 7-50

Introductory offer p & p free. Please add 15%
VAT. Allow 28 days delivery. DEALER ENQUIRIES
WELCOME.

COLEWOOD COMPUTERS LIMITED, 25 Sycamore Avenue,
St. Austell, Cornwall, PL25 4DR.

● Circle No. 237

CP/M	Haywood Associates Ltd	£350	
CP/M	Median-Tec Ltd	£500	500 a/c 5,000 trans
CP/M	Ludhouse Ltd	£500	2,000 a/c 8,000 trans
CP/M	Graffcom Systems Ltd	£450	540-7,000
CP/M	Computerstore Ltd	£400	500 a/c 3,500 trans
CP/M	Salmon Microcomputing	£350	1,000 a/c 24,000 trans
CP/M	Selven Systems	£600	500 a/c 5,000 trans
CP/M	Map Computer Systems Ltd	£300	400-96,000 a/c
CP/M	Daman Computer Services	£900	1,500 a/c 500 trans
CP/M	P R Daly & Co Ltd	£350	
CP/M	Interface Computer	£350	varies
CP/M North Star	Services		
Durango F-85	Benchmark CS Ltd	£250	200 a/c 500 trans
Exidy Sorcerer	Kesho Systems	£500	
Horizon	Basic Computing	£125	See also Micropute
Tandy Models 1 & 2	Claisse-Allen Computing	£500	800 a/c 2,000 trans
Tandy TRS-80	Chess Consultancies Ltd	£250	300 a/c
Tecs	Tridata Micros Ltd	£225	175 a/c 1,350 trans
Z-80	Jar Software Systems	£550	500 a/c
	Liveport Ltd		

Stock Systems

Machine type	Supplier name	Price	Capacity
Apple II and III	Systematics	£250	
Apple II	Logic Box Ltd	£490	1,200 items
Apple II	Vlasak Electronics Ltd	£150	7,000 items
Apple II	Dataforce (U.K.) Ltd	£200	850 items
Apple II	U-Microcomputers Ltd	£199	
Apple II	Microsense Computers Ltd	£100	
Apple II	Informex London Ltd	£198	
Apple II	Southern Computer Systems	£1,000	
Apple	Style Systems Ltd	£250	900-80,000 items
Apple II/ITT	Microdigital Ltd	£225	625 items
Apple II/ITT	Vlasak Electronics Ltd	£285	500 items
Apple II/ITT	Systematics International Ltd	£500	200-2,500 items
Apple II/ITT	Guestel Ltd	£300	
Apple II/ITT	Padmede Computer Services	£300	2,000 postings
Apple II/ITT	The Software House	£80	800 items
Commodore	Comsoft Associates	£350	
Commodore 3000	Intex Datalog Ltd	£195	2,400-3,700 items
Commodore 3000/8	Commodore BM (U.K.) Ltd		600-2,000 items
Commodore 3000/8	Rockliff Brothers Ltd	£275	3,400-10,000 records
Commodore 3032	Logma Systems Design	£600	1-6 shops
Commodore 3032	ACT (Petsoft) Ltd	£75	2,400 items 1,000 a/c
Commodore 3032	ACT Microsoft Ltd	£75	1,200-5,900 items
Commodore 3032	Anagram System	£320	500-600 items 255 a/c
Commodore 3032	L & J Computers	£60	500 items
Commodore 3032	Bristol Software Factory	£300	2,300 items
Commodore 3032	Stage One Computers	£100 and	600-650 items
Commodore 3032	SMG Microcomputers	£395-£495	2,450-7,000 items
Commodore 3032	Compfer Ltd	£350	200 lines 20 bars
Commodore 3032/8	Compsoft Ltd	£190	13,000
Compucorp	Verwood Systems	£250	
CP/M	Bromley	£400	
CP/M	Sail	£250	
CP/M	P R Daly	£200	
CP/M	Typestyle	£250	
CP/M	Johnson	£200	
CP/M	CPL Ltd	£300	
CP/M	Goldcrest	£300	
CP/M	Wisbech	£300	
CP/M	Bytesoft	£700	2,000-8,000 lines
CP/M	Compsoft Ltd	£400	27,000



CP/M	Microtek Computer Services	£750	
CP/M	P R Daly & Co Ltd	£350	
CP/M	Great Northern CS Ltd	£375	1,500
CP/M	Haywood Associates Ltd	£350	
CP/M	Median-Tec Ltd	£500-£800	1,000 items
CP/M	Microbits	£500	varies
CP/M	Graffcom Systems Ltd	£350	350 records/disc
CP/M	Salmon Microcomputing	£400	5,000 items
CP/M	Map Computer Systems Ltd	£250	
CP/M	Ludhouse Ltd	£1,000	12,000 parts
CP/M	Interface Computer Services	£350	varies
CP/M	Selven Systems	£600	
CP/M Cromenco	Micromedia Systems	£1,000	
CP/M Horizon	Microtek Computer Services	£500-£1,000	varies
CP/M North Star	Benchmark CS Ltd	£450	350 items 275 trans
CP/M Vector	Taylor Micro Systems	£995	4,000 items/Mbyte
North Star DOS	Intelligent Artifacts Ltd	£195	
Exidy Sorcerer	Basic Computing	£125	
Tandy TRS-80	Chess Consultancies	£995	
Tandy TRS-80	A J Harding (Molimerx)	£150	1,000 items
Tandy TRS-80	Cleartone ADP	£325	4,000 items
Tandy TRS-80	Chess Consultancies	£750	500 items six sites
Tandy TRS-80	FIBS	£750	
Tandy TRS-80	Micro Gems	£150	1,000 items
Tandy TRS-80	Tridata Micros Ltd	£200-£375	630 items/disc
Tandy TRS-80	Microgems Software	£150	1,000-2,000 items
Tecs	Jar Software Services	£800	10,000 items 5,000 orders
Tecs	Jar Software Services	£850	1,000 items 300 a/c
Zilog MCZ range	Microbits	£500	2,300 items
Z-80/8080	Graham Dorian Software	£325	varies
Z-80/8080	Rogis Systems Ltd	£600	900-3,500 items
Z-80 MCZ	Software Architects Ltd	£600	varies
Z-80	Liveport Ltd		

Word Processing

Machine type	Supplier name	Price	Comments
ACT Sirius	ACT Microsoft	£295	WordStar
ACT Sirius	ACT Microsoft	£325	Select
Apple II	Rocon	£170	Zardax
Apple II	Dataforce (U.K.) Ltd	£190	
Apple II	SBD Consultants Ltd	£60	
Apple II	Keen Computers	£275	
Apple II/ITT	Systematics International Ltd	£75	
Apple II/ITT	Algobel Computers Ltd	£75	
Apple II/ITT	Personal Computers Ltd	£225-£300	
Commodore 3000	Stage One Computers Ltd	£125	
Commodore 3032	Dataview Ltd	£159	
Commodore 3032	ACT (Petsoft) Ltd	£325	
Compucorp	Verwood Systems	£500	
CP/M	Wisbech Computer Services	£245	
CP/M	Interface Computer Services	£200	
CP/M	Microbits	£230	
CP/M North Star	Intelligent Artifacts	£250	
CP/M Vector	Taylor	£395	
North Star ('c')	Intelligent Artifacts	£250	
Z-80 Superbrain	Alan Pearman Ltd	£225	

Miscellaneous

Machine type	Supplier name	Price	Application
Apple II	Wida	£120	German language-learning package
Apple	Attar	£280	Dental lab package

SEARCHING FOR BEST PRICE FOUND BEST PRICE . . . GO TO ORCHARD

PET	CASSETTE	RRP	
C2N		£55	Our own transport delivers nationwide weekly. All you need is our Best Price Quotation. Contact us now! For super service.
4016	16K	£550	
4032	32K	£895	
8032	32K	£895	
8096	96K	£1195	
DISK DRIVES			
2031	170K	£395	
4040	343K	£695	
8050	1M	£895	
8250	2M	£1295	
9060	5M	£1995	
9090	7.5M	£2495	
PRINTERS			
4022P	80CDL.BIDIR	£395	
8023	136CDL	£895	
8300	DAISY	£1395	

If you know what you want why wait?

ORCHARD COMPUTER SERVICES
ORCHARD HOUSE, 21 ST. MARTINS ST.,
WALLINGFORD, OXON.
TEL: WALLINGFORD (0491) 35529

● Circle No. 238

OSBORNE 1

IN OXFORDSHIRE

WE DEMO AND
DELIVER TODAY

4B

0295.66555

COMPUTER SERVICES

● Circle No. 239

Save £££

on

Matrix Printers

All popular micros including BBC.
Rin for prices for Epson range of
printers with or without graphics
on Bracknell (0344) 50720 any-
time.

● Circle No. 240

"ZX GRAPHICS PROGRAMMING MADE EASY"

Full Colour A4 Manual, 24 pages packed with ZX Graphics Programming techniques and ideas for games and "serious" Programs. Written in "easy to understand" language and illustrated at every stage.

Ideas include:
Information Graphics
Sketch-Pads
Saving your "Art".
Making serious
programs interesting.
Graphics Stringing.
ZX Printer Graphics

£1.50

(INCLUDING UK POSTAGE)
Print'n'Plotter Products (PCL)
19 Borough High Street,
London SE1 9SE.



● Circle No. 241

APPLE DEALER
FOR
PETERSFIELD & GUILDFORD

WILL DEMONSTRATE COLOUR GRAPHICS
DATA BASE/MAILING LIST
TABS ACCOUNTING SYSTEM

FOR SALES & SERVICE:
ACCESS CONTROL SYSTEMS LTD.
72 WINCHESTER ROAD,
PETERSFIELD, HANTS GU32 3PW
Tel: Petersfield (0730) 5274



● Circle No. 242

ATOM HARDWARE INTERFACES

- ★ Serial Interface card
- ★ Real Time Clock card
- ★ Joystick and Controller
- ★ Analogue-Digital Digital-Analogue card
- ★ Home Power Controller System
- ★ Custom interfaces made to your specification

For further details either fill in Reader Enquiry Service card, or call direct.

S A KIRK
TEL: (01)-470 3673

● Circle No. 243

Complete Business System TRS 80

48K Model I Level II, Double Density upgrade, Lower Case upgrade, Numeric Key pad, complete with Interface, System Desk, Green Screen, etc. £795.00

To suit above: 2 Shugart SA 400 disk drives, 35 track Double Density. £145.00

Alternative: Teac 80 Track Double Density twin drives. £455.00

Two of these twin drives will give total disk storage of app. 1.5 MB

Also Centronics Dot Matrix Printer Model 779. £195.00

We also have Business Software, specifically written for this model and orientated towards distribution and accounting.

Please phone Wolverhampton (0902) 710 700 for further details.

● Circle No. 244

Educational Programs

BBC MICRO

GEOGRAPHY — Italy — colour map displays, regions, cities, mountains, rivers — text and testing £5

MATHS — Translations — colour diagrams, explanations, tests £5

SUITABLE 9-15 yr. olds
Please state whether 16k or 32k

CORONA (Software),
21 Tennyson Ave,
London E.11. Tel: 01-989 8534

● Circle No. 245

Apple II and III	Northern Computers	£290-£690	Price discounting
Apple II	Vlasak Electronics	£30	Petrol pump losses
Apple II	Humac Ltd	£1,000	Auctioneer's package
Apple II	Humac Ltd	£600	Invoicing sales — timber
Apple II	Humac Ltd		Microfiche records
Apple II	Keen Computers	£499	Inhouse teletext
Apple II	Keen Computers	£499	Graphics
Apple	Style Systems Ltd	£750	Retail warehouse management
Apple II/ITT	Informex Logic	£198	Insurance records
Apple II/ITT	Informex Logic	£198	Time records — solicitors
Apple II/ITT	Diskwise	£198	TV rental management system
Apple II/ITT	Cyderpress	£650	Auction system
Apple II/ITT	CPR Systems Ltd	£960	Insurance brokers system
Apple II/ITT	Personal Computers	£195	Operational research
Apple II/ITT	Personal Computers	£100	Time series analysis
Apple II/ITT	Padmede Computers	£500	Insurance brokers system
BBC Model B	Typestyle	£750	Retail newsagents
Commodore	Comsoft Associates	£450	Domestic central-heating estimates
Commodore Vic	The Computer Room	£250	Newsagents'
Commodore 3000	Anagram Systems	£850	Media control system
Commodore 3000	Anagram Systems	£800	Slot machine monitor
Commodore 3000	The Alphabet Company	£350	Newsagent suite
Commodore 3032	Microland	£175	Printers quote system
Commodore 3032	Stage One Computers	£100	Insurance brokers system
Commodore 3032	Stage One Computers	£200	Printers job control
Commodore 3032	Commodore BM (U.K.)	£50	Appointments planner
Commodore 3032	CSM Ltd	£500	Window replacement
Commodore 3032	S A Systems	£550	Farming — office systems
Commodore 3032	L & J Computers	£420	Machine hire
Commodore 3032	Mandata Ltd	£1,000	Insurance brokers
Commodore 8000	Peach Data Services	£350	Library retrieval system
Commodore 8000	Peach Data Services	£550	Footware industry sales reporting
Commodore 8000	Peach Data Services	£995	Clients home accounting
Commodore 8000	Stage One	£800	General accounting package
Commodore 8000	Stage One	£330	Petaid/Wordcraft/Visi-Calc link
CP/M	Orchard	£200	Manufacturing shortage control
CP/M	Orchard	£150	Shortage progress chasing
CP/M	The Computer Room	£980	Newsagents accounts and distribution
CP/M	Core	£1,500	Advertisers accounts system
CP/M	Core	£1,500	Insurance brokers accounts system
CP/M	Core	£350	Recruitment agency system
CP/M	Bromley	£2,000	Bookmakers system
CP/M	Bromley	£1,000	Industrial cleaners system
CP/M	Bromley	£2,000	Investment brokers system
CP/M	Bromley	£400	Property management
CP/M	P R Daly	£1,050	Contract costing
CP/M	P R Daly	£2,000	Integrated solicitors accounting

Buyers' Guide

CP/M	P R Daly	£500	Time recording
CP/M	Vauntberry	£1,950	Production control
CP/M	Vauntberry	£2,200	Requirements planning, bill of materials, stock control
CP/M	Vauntberry	£1,000	Double-glazing design and costing
CP/M	Johnson	£200	Insurance brokers
CP/M	Johnson	£200	Prestel software
CP/M	Basys	£1,000	Estate agents
CP/M	Benchmark Ltd	£350	Time recording
CP/M	Bytesoft	£850	Work in progress
CP/M	Bytesoft	£150	Perpetual inventory
CP/M	Bytesoft	£850	Bill of materials
CP/M	Bytesoft	£200	Kit control
CP/M	Microtek	£500	Garage system
CP/M	Horizon Software	£1,000	Integrated business system
CP/M	Horizon Software	£400	Costing systems
CP/M	Research Resources	£240	Statistical analysis
CP/M	Sail	£1,000	Jewellers integrated system
CP/M	Sail	£1,850	Publishers integrated stock and accounts
CP/M	Sail	£600	Retail stock
CP/M	Salmon Microcomputer	£180	Appointments planner
CP/M	Selven Systems	£400	Nominal ledger
CP/M	Map Computer Systems	£450	Time recording
CP/M	Map Computing Systems	£760	Calor system
CP/M	Map Computer Systems	£425	Newsboy/newsagents system
CP/M	Haywood	£500	Time recording
CP/M	Comput-a-Crop	£1,000	Farm management
CP/M	Microtek	£1,000	Plant hire
CP/M	Goldcrest	£300	Nominal ledger
CP/M North Star	Micromedia	£195	Vehicle maintenance
CP/M	Taylor Microsystems	£800	Bill of materials
Ohio Scientific	Stratheden Ltd	£300	Statistics package
Ohio Scientific	Stratheden Ltd		Insurance brokers system
Ohio Scientific	Stratheden Ltd		Hospital package
North Star DOS	Intelligent Artifacts	£52	Parts list management and ordering
North Star Horizon	Wisbech Computer Services	£750	Double-glazing manufacturer
North Star Horizon	Wisbech Computer Services	£750	Double-glazing costs
North Star Horizon	Wisbech Computer Services	£450	Time recording
SuperBrain	Alan Pearman Ltd	£190	Statistics package
SuperBrain	Alan Pearman Ltd	£105	APL utility functions
SuperBrain	Alan Pearman Ltd	£225	APL Text editor/ processor
SuperBrain	Alan Pearman Ltd	£125	Micro-mainframe communications
SuperBrain	Alan Pearman Ltd	£490	Modelling/simulation
SuperBrain	Alan Pearman Ltd	£325	Actuarial calculations
SuperBrain	Alan Pearman Ltd	£75	Password security system
SuperBrain	Alan Pearman Ltd	£225	Report formatting
SuperBrain	Alan Pearman Ltd	£195	CP/M networks
SuperBrain	Alan Pearman Ltd	£380	Hard graphics copy
Tandy TRS-80	Typestyle	£1,500	Wholesale newsagent
Tandy TRS-80	Chess Consultancies	£995	Haulage administration
Tandy TRS-80	Clearstone ADP	£300	WIP and invoicing system
Tandy TRS-80	Clearstone ADP	£500	Patient and drugs records
Tandy TRS-80	P J Norris	£1,000	Comprehensive sales and purchase

SHOP WINDOW



ACORN
Atom & BBC

Your local Fruit and Nut

NORTHERN COMPUTERS
Churchfield Rd, Frodsham,
Warrington WA6 6RD.

0928 35110

● Circle No. 246

OSBORNE 1

IN WARWICKSHIRE

WE DEMO AND
DELIVER TODAY

4B

0295.66555

COMPUTER SERVICES

● Circle No. 247

All Prices Inclusive: Access Holders Ring (0249)
3241 Ex. 39

VIC SOFTWARE
SPACE HOPPER

A fast action game of skill and excitement, can you guide your space frog through the hustle and bustle of space traffic, without being crushed by intergalactic space trains, can you avoid being shot by hidden laser guns and are you able to hop through the small gaps provided by the space traffic. This incredible game is very fast moving and the use of HI-RES graphics make it a game not to be missed. No Vic owner should be without this one.

SUPPLIED ON CASSETTE AT £7. (unexpanded Vic)

For more details on software ring the "TITAN HOTLINE" or send a SAE for our latest catalogue. GENEROUS DEALER DISCOUNTS AVAILABLE. SEND NOW FOR OUR PRICES.

OTHER CASSETTES INCLUDE (for the unexpanded Vic)
STAR WARS II at £7.
NAVAL ATTACK at £7.
& TROLL ISLAND (a great adventure game) at £6.

TITAN HOTLINE on 0225 810132 or 0249 55854
For instant despatch send cheques or postal orders
to:

**TITAN PROGRAMS, 83 ASHWOOD ROAD, RUD-
LOE, CORSHAM, WILTSHIRE SN13 0LG.**

● Circle No. 248

STEMMOS LTD ANNOUNCES AUTOCODE

Automatic development of d-Base II
program code without any program-
ming.

- ★ Automatic Menus
- ★ Automatic Data Entry Screens
- ★ Automatic Data Entry Routines
- ★ Automatic Edit/Validation.
- ★ String, Numeric, Data and calcu-
lated fields.
- ★ Automatic Multiple Reports
- ★ Automatic Programs in d-Base
code with interactive screens.

STEMMOS LTD
344 KENSINGTON HIGH STREET,
LONDON W14

TEL: 01-602 6242

d-Base II TM Ashton Tate

● Circle No. 249



DISKS STATIONERY PRINTERS

Special offers on disks, stationery and printers

Floppy diskettes in boxes of 10
 5 $\frac{1}{4}$ " s/s s/density s/sectored only £15.00
 8" s/s s/density s/sectored only £20.70
 (Add £1.00/box P & P + Vat.)

Continuous stationery-1000 sheets

9 $\frac{1}{2}$ "x11" Plain single part only £4.61
 9 $\frac{1}{2}$ "x11" Plain (with $\frac{1}{2}$ " margins) only £5.96
 14 $\frac{1}{2}$ "x11" Lined or plain single part only £6.06
 (Includes delivery, excludes Vat.)

Printers from Newbury Labs

Special Introductory Offer
 A free box of 9 $\frac{1}{2}$ "x11" Stationery with every Newbury Printer purchased

The 8510 (11" carriage) only £480.00
 The 1550 (15" carriage) only £650.00

For the printer that has everything standard, buy The Newbury 8510 or 1550. Price includes 6' cable



CDP Consultants Limited
 Ring Clavering (079985) 617

● Circle No. 250

"IC TEST SOFTWARE"

Written for Gen-Rad 1732 Digital IC test systems. Ideal for goods inwards checking etc. competitive service.
 Contact:

Micro-Developments (UK) Ltd
 01-656-7782

● Circle No. 251

MONOPOLY

TANDY V. GENIE

- ★ Computer challenges you at Monopoly as a player.
- ★ For up to 6 players (including computer).
- ★ Unique system featured whereby computer detects the skill of best player then adjusts its skill automatically to match that player.
- ★ Computer's game at highest level is 'strong'.
- ★ Every game different, close, exciting and challenging.
- ★ Game data can be saved on tape to continue game at another time.
- ★ Easy fool-proof entry ideal, even for children to use.
- ★ 2 versions of Monopoly included. 'Standard' — as to rules. 'Popular' — slight variation to rules.
- ★ Many, many hours of fun for all the family.

On tape for the VIDEO GENIE and TRS-80. Model 1 & 3. Level 2. 16k. £9.95 inclusive.

COMPUTICS 1 BELL LANE
 MICROSOFT WHEATLEY OXFORD OX9 1XY

● Circle No. 252

Tandy TRS-80	Quickmet	£785	Integrated accounts package
Zilog MCZ range	Microbits	£1,000	Insurance brokers system
Zilog MCZ range	Microbits	£1,000	Production control
Zilog MCZ range	Microbits	£1,000	Bill of materials
Z-80/8080	Intereurope	£500	Conference organiser

Alphabetical list of suppliers

Supplier	Address	Sales
3-Line Computing 0482-445496	36 Clough Road Hull HU5 1QL	Tim Hill
ACT Microsoft Ltd 021-454-8585	ACT House 111 Hagley Road Edgbaston Birmingham B16 8LB	Matthew Wauchope
Aerco-Gemsoft 04862-22881	27 Chobham Road Woking, Surrey	
A J Harding (Molimerx) 0424-22039	28 Collington Avenue Bexhill-on-Sea, East Sussex	John Harding
Alan Pearman Ltd 0244-46024/21084	Maple House, Mortlake Crescent Chester CH3 5UR	
Algobel Computers Ltd 021-233-2407	33 Cornwall Buildings Newhall Street Birmingham B3 3QR	Amanda Anders
Amplicon M S Ltd 0273-608331	Richmond Road Brighton, Sussex BN1 6JA	Peter Wood
Anagram Systems 0403-50854	60a Queens Street Horsham, West Sussex RH13 5AD	
Analog Electronics 0203-417761	47 Ridgeway Avenue Coventry	
Atlanta Data Systems Ltd 01-739-5889	350/356 Old Street London EC1V 9DT	Frank Laughton
Attar Computers Ltd Leigh 671491	211 St Helens Road Leigh, Lancashire WN7 3BR	David Isherwood
Basic Computing 0535-65094	Oakworth Road Keighley, West Yorkshire BD22 7LA	Mike Collier
Basys Ltd 01-953-7303	191-195 Shenley Road Borehamwood, Hertfordshire WD6 1AW	Cliff Gudgeon
Benchmark CS Ltd 0726-61000	7-8 Aylmer Square St Austell, Cornwall PL25 5LL	John Fisher
Bonsai Ltd 01-580-0902	112-116 New Oxford Street London WC1A 1HJ	Michael Kraftman
Bristol Software Factory 0272-277135	Kingsons House, Grove Avenue Queens Square, Bristol BS1 4QP	W J Kyle-Price
Bromley Computer Consultancy Ltd 01-464-8080	244A High Street Bromley, Kent BR1 1PQ	Anthony Burrige
Business Solutions Ltd 01-554-5985/0582	1 Park Avenue, Ilford Essex IG1 4LU	S Page
Bytèsoft Systems Limited 0533-531441	16 New Street Leicester LE1 5NR	David Biggins
Chess Consultancies Ltd 061-832-6792	Progress House 31-33 Mount Street, Salford Manchester M3	D G West
Cleartone ADP 0495-244555	Prince of Wales Industrial Estate Abercarn, Gwent NP1 5RJ	C J Holbrook
Clenlo Computing Services 01-653-6028	15 South View Court The Woodlands, Beulah Hill London SE19	
Commodore BM (U.K.) Ltd Slough 74111	818 Leigh Road Slough Industrial Estate Slough, Berkshire	A Gould



Compfer Ltd 0772-57684	Preston Computer Centre 6 Victoria Buildings, Fishergate Preston, Lancashire	
Compsoft Ltd 0483-39665/505918	Great Tangle, Manor Farm Wonersh, Guildford, Surrey	Jenny Wilson
Comput-A-Crop 01-771-0867	32 Whitworth Road London SE25 6XH	Laurence Payne
Computech Systems 01-794-0202	168 Finchley Road London NW3	E Chisman
Comsoft Associates 021-449-9151	..C-2D Wake Green Road Moseley, Birmingham B13 9EZ	D Fisher
Core International Ltd 0785-42611	92 Wolverton Road Stafford, Staffs ST17 4AH	L Roberts
CPL (Cwmni Peirrianneg Lllyn Ltd) (0758) 3035	Liverpool House, Pwllheli Gwynedd LL53 5DE	Roger Taylor
CPR Systems Ltd 04492-5488	37-39 Ipswich Street Stowmarket, Suffolk	Stewart Smith
CPS (Data Systems) Ltd 021-707-3866	Arden House, 1102 Warwick Road Acocks Green Birmingham B27 6BH	Peter Mart
CSC (Northern Ltd) (0274) 391076	"Ash Court", 2 Ash Grove Great Horton Road Bradford BD7 1BN	C Murphy
CSM Ltd 021-382-4171	Refuge Assurance House Sutton New Road, Birmingham	LJ Watson
Cyderpress Ltd 0491-37769	2 Church Lane Wallingford, Oxfordshire	Peter Daly
Daman Computer Services 061-793-7015	Kennedy House, Rutland Street Swinton, Manchester M27 2AU	
P R Daly & Co Ltd 09274-29815	Oaklands Gate, Northwood Middlesex HA6 3AA	
Deltec Computing Ltd Basingstoke 59715	2nd Floor, May Place House May Place, Basingstoke, Hampshire	
Diskdean Ltd 01-242-7394	23 Bedford Row London WC1R 4EB	R Cornforth
Diskwise Ltd 05793-3780	25 Fore Street Callington, Cornwall	
D T Systems (0603) 27833	32 Surrey Street Norwich NR1 3NY	M Kusmirak
Equinox Computer Systems 01-739-2387/9	Kleeman House, 16 Anning Street New Inn Yard, London EC2	John Metcalf
Fully Integrated Business Systems Ltd 021-328-7920	18 Hanover Drive Gravelly Industrial Park Tyburn Road, Birmingham B24 8TE	H Sigerson
Gilmorehill Software Ltd 041-332-2013	26 Park Circus Glasgow G3 6AP	C Hartnett
Goldcrest Computer Services Newport Pagnell 613188/611988	67 Union Street, Newport Pagnell Buckinghamshire	
Graffcom Systems Ltd	52 Shaftesbury Avenue London	Barbara Castedine
Graham Dorian Software 01-379-7931	c/o Lifeboat Associates 32 Neal Street, London WC2H 9PS	
Great Northern Computer Services 0532-589980	16 Town Street Horsforth, Leeds LS18 4RJ	
Guestel Ltd 0225-65379	Refuge House 2-4 Henry Street, Bath	Allan T'impany
G W Computers Ltd 01-636-8210	55 Bedford Court Mansions Bedford Avenue, London WC1	Tony Winter
Hayden Young Ltd 01-387-4377	PO Box 117, 141 Euston Road London NW1 2AY	
Haywood Associates Ltd 01-428-9831	11 Station Approach Northwood, Middlesex	
HB Computers Ltd 0536-520910	22 Newland Street Kettering, Northamptonshire	Johnny Johnson

SYSTEMS OF TOMORROW

announce
THE OSBORNE PLUS RANGE
OSBORNE + 340 Kbytes floppies £1,450
OSBORNE + 790 Kbytes floppies £1,650
OSBORNE + 5 Mb to 21 MKB Winchester
hard disks from £2,200
OSBORNE + with standard disks + SOFT
utility package £1,255
Prices exclude VAT

Contact
SYSTEMS OF TOMORROW LTD
109c High Street,
Chesham, Bucks.
Tel: Chesham (0494) 786989

● Circle No. 253

impETUS

Owing to further expansion, IM-
PETUS COMPUTER SYSTEMS
seek experienced PROGRAM-
MERS on perm. or contract basis.
Hendon area.

Call Cliff Stamford on 01-202 2726 or
01-202 9630

● Circle No. 254

MACHINECRAFT

OFFERS 40% ROYALTIES
FOR ZX81 SPECTRUM AND
ATOM
SOFTWARE

SEND
SOFTWARE ON CASSETTE
OR S.A.E. FOR DETAILS TO:

MACHINECRAFT LTD
P.O. BOX 2
COGGLESHALL, COLCHESTER
CO6 1TJ

● Circle No. 255

MICROCASE

"turns a board into a real computer"

For NASCOM 2
COMPUKIT
SUPERBOARD
ALSO UNCUT FOR NASCOM 1
ETC.

Direct from us or from your dealer —
but make sure you see a

GENUINE MICROCASE

SIMPLE SOFTWARE LTD
15 HAVELOCK ROAD
BRIGHTON, SUSSEX BN1 6GL
(0273) 504879



● Circle No. 256

KEYBOARD DUST COVERS FOR PETS

Keep your Pet Commodore keyboard free from contamination by fitting a superb flexible high quality transparent silicone rubber cover. Does not shrink; withstands boiling water, etc.

Keys operate with cover in place, ideal for exposed machines running daily in offices, labs, warehouses, etc. Covers fit all Commodore, Pet/IBM with large keyboard, including the 80 column models (covers will also fit other computers with similar size keyboard).

Price per cover £8 + 90p VAT

Send cheque/PO to:

D.B.M. Products,

P.O. Box 6, Melton Mowbray,
Leicestershire LE13 1YL.

Please allow 28 days delivery.

Registered in England No. 2798902.

● Circle No. 257

INSURE YOUR COMPUTER

Impact damage, Fire & Theft Insurance for your Computer, Equipment:

£1 to £1,500 cover £8.00 p.a.
£10 (excess) x/s

£1,500 to £2,500 £16.00 p.a.
£15 x/s.

For details:

KGJ Insurance Brokers,
6 Hagley Road, Stourbridge,
West Midlands, DY8 1QG
Tel (03843) 5333/2545

● Circle No. 258

ANADEX DP. 9501 printer,

Bi-directional, 220 CHAR/SEC, 200 CHAR/SEC. Adjustable width tractor feed. Also Lear Seigler ADM 3A VDU terminal. Cost over £2,000 new. Offers considered around £1,000. Both in working order, virtually unused, COMPANY LIQUIDATION forces sale. Telephone C. DONNELLY, 0782-279901 (Daytime). 61 Broad Street, Hanley, Stoke-on-Trent, Staffordshire.

● Circle No. 259

MICRO ADS

are accepted from private readers only, pre-paid and in writing, 20p per word, minimum charge £2.

Please make cheques payable to Practical Computing and send to Room L310, Quadrant House, The Quadrant, Sutton, Surrey SM2 5AS.

ACORN ATOM 12K + 12K, PSU, software, Atom Magic Book, manual. £200. Tel: (0573) 24516 (evenings).

WORDSTAR FOR SIRIUS — simpleminded farmer finds the program too complicated for daily use. £225 ono (+vat). Tel: 0234-865 469.

MZ-80K horse-race analysis. Winners galore. Cassette £5.75. Details: SAE P. C. Birch, "Moorside" Woodlands, Wimbourne, Dorset.

ZX81 16K BASIC line re-numbering and multi-line erasure. M/C code, cassette £3.95p. M. J. Franklin, 69 The Heights, Northolt, Middx.

VIDEO GENIE 16K extra keys VU meter and sound. Software assembler disassembler games. 6 months sub on magazine. As new in box. £275.01 946 1429.

Hevacomp Ltd
Sheffield (0742) 52752

Horizon Software Ltd
0533-556550

Humac Ltd
Romford 752005

IBIS Business Information
Systems Ltd
061-881-0585

Informex London Ltd
01-318-4213/7

Instar Business Systems
01-680-5330

Intelligent Artefacts
0223-207689

Intereurope SD Ltd
0734-789183

Interface Computer
Services Ltd
0376-518112

Ismail CAD
01-802-0019

James C Steedman
0903-814923

Johnson Microcomputers
Camberley (0276) 20446

Keen Computers
0602-583254

Kesho Systems
041-226-4236

KGB Micros Ltd
Slough (75) 38319

L & J Computers
01-204-7525

Landsler Software
01-399-2476/7

Liveport Ltd
0736-798157

Logic Computers
01-222-1122

Logma Systems Design
Bolton 389854

Ludhouse Ltd
01-679-4321

Map Computer Systems Ltd
061-624-5662

Median-Tec
0734-664969

Metrotech
0895-58111

Micro Computation
01-882-5104

Micro Focus

Microact Ltd
021-454-8585

Microbits
0734-792021

Microcomp
0703-21397

Microcomputer Applications
0734-470425

Microcomputer BM
01-981-3993

Microdigital Ltd
051-227-2535

25 Byron Road
Sheffield S7

Regent House, 16 West Walk
Leicester LE1 7NG

168-186 South Street
Romford, Essex RM1 1TR

Pargate House, Cross Road
Chorlton-cum-Hardy
Manchester M21 1DH

8-12 Lee High Road
London SE13 5LQ

61 High Street
Croydon, Surrey

Cambridge Road
Orwell, Hertfordshire

19-21 Denmark Street
Wokingham, Berkshire

RG11 2QX
First Floor, 17 Guithavon Street
Witham, Essex

47a St Johns Road, Tottenham
London N15 6QS

18 Manor Road, Upper Beeding
Steyning, Sussex

Johnson House
75-79 Park Street, Camberley
Surrey GU15 3XE

5b The Poultry
Nottingham

72 Waterloo Street
Glasgow G2

14 Windsor Road
Slough, Berkshire SL1 2EJ

3 Crundale Avenue
Kingsbury, London NW9 9PJ

29a Tolworth Park Road
Surbiton, Surrey KT6 7RL

The Ivory Works
St Ives, Cornwall

31 Palmer Street
London SW1

2-10 Bradshawgate
Bolton, Lancashire

2-6 Marian Road
London SW16 5HR

111 Union Street
Oldham, Lancashire OL1 1RU

120 Oxford Road
Reading, Berkshire

Waterloo Road
Uxbridge, Middlesex UB8 2YW

8 Station Parade
Southgate, London N14

c/o Lifeboat Associates
32 Neal Street, London WC2

Act House,
111 Hagley Road, Edgbaston
Birmingham B16 8LB

Barford House, Shute End
Wokingham
Berkshire RG11 1BJ

125 High Street
Southampton SO1 0AA

11 Riverside Court
Caversham, Reading
Berkshire

4 Morgan Street
London E3 5AB

25 Brunswick Street
Liverpool L2 0BJ

A J Baxter

John Oatham

F Brown

O Ismail

R V Johnson

Bob Ellis

Angus Nial

Sandy Saunderson

Jack Goodman

E Ländsler

M Ward

G Rigby

R A Adey

Graham Jones



Microgems Software 0602-275559	32 Buckingham Avenue Hucknall, Nottinghamshire	
Microland 0723-70715	17 Victoria Road Scarborough, North Yorkshire	
Micromedia Systems Newport 59276/7	Seymour House 14-16 Chepstow Road Newport, Gwent	
Micro-Pension 01-394-2049	24 High Street Ewell, Surrey	Roger Millard
Micropute 0625-612818	Communique Place 9 Prestbury Place Macclesfield, Cheshire	
Microsense 0442-41191/48151	Finway Road Hemel Hempstead Hertfordshire	
Microtek 0689-26803	50 Chislehurst Road Orpington, Kent	
Minicomputer CS Ltd 0494-448686	Pilot Trading Estate 163 West Wycombe Road High Wycombe Buckinghamshire	
Missing Link 01-349-4711	Abacus House 53-55 Ballards Lane London N3	
MJN Consulting Ltd 01-941-3327	105 Walton Road East Molesey, Surrey KT8 0DR	Michael Norman
MMS Computer Systems 0234-40601	26 Mill Street Bedford	
Northern Computers Warrington (0925) 601683	Churchfield Road Frodsham, Cheshire WA6 6RD	Chris Piff
Omicron Management Software Ltd 01-636-6575	Mayfair House 39 Great Portland Street London W1N 5DG	
Orchard Microsystems Ltd 0455 209126	PO Box 12, Lutterworth Leicestershire LE17 5TA	R Tattersall
Padmede Computer Services 025-671-2434	112/116 High Street Odiham, Basingstoke Hampshire	John Packwood
PCL Software Ltd 021-552-6126	146-150 Birchfield Lane Oldbury, Warley West Midlands B69 2AY	P Hemmings
Peach Data Services Ltd 0283-44968	5 Horinglow Street Burton on Trent DE14 1NJ	Brian Homewood
PE Consulting Group Egham (0784) 34411	Park House, Egham Surrey TW20 0HW	Jan Szymankiewicz
Personal Computers Ltd 01-626-8121/2/3	194-200 Bishopsgate London EC4M 4NR	Mike Hardwick
PK Microsystems Ltd 01-839-3143	46-47 Pall Mall London SW1Y 5JG	
P J Norris Computer Applications 053-183-428	Rochester House, Canon Frome Ledbury, Herefordshire HR8 2TG	P J Norris
Quickmet Software Development 0202-888217	57 Leigh Road, Wimborne Dorset BH21 1AE	I Metcalf
Redwood Bureau Services 0707-42424	86 Queens Road Watford, Hertfordshire	Peter Osborne
Research Resources Ltd 07073-26633	40 Stonehills Welwyn Garden City Hertfordshire	
Rockliff Brothers Ltd 051-521-5830	2 Rumford Street Liverpool L2 8SZ	M Taylor
Rocon Ltd 0235-24206	Radley Road Industrial Estate Radley Road, Abingdon Oxfordshire	David Elliot
Sail (Software Aids International Ltd) 01-904-8139	16 Norval Road North Wembley Middlesex HA0 3TE	David Bull
SA Systems Newbury 45813	Allington Lodge, Round End Newbury, Berkshire RG14 6PL	S A Trinder

SYM-1 and Teletype fully working 8K. BASIC, RAE, SUPERMON II. Fully documented. £250 ono. Tel: 0386 3148.

BETTER APPLE II colour. Full modification details — £3. '10 Applesoft Games' disk £20. H. Hopkins, 117 St. John's Road, Exmouth Devon.

TRS 80 L2 16K, software, games and cassette also available. £280. Macclesfield (0625) 31699.

ACORN ATOM 8K ROM 12K RAM. 5 volt external PSU, manuals, books, disassembler, chess, invaders etc — complete with tape deck £195. 051 526 7087 day.

PET 4040 disk drive + BASIC-4 ROMS £500. PET 3016 + cassette + toolkit £425. 2022 printer £250. All 3 £1,100. (Could deliver in West Midlands/North West). Telephone Penrith (0768) 62621 evenings only.

FORTH for UK-101 . . . may be modified for Superboard. Learn on 8K machine. Includes incremental compiler, documentation and sample programmes e.g. 6502 Assembler. £12 W. A. Powell, 16 Vantorts Road, Sawbridgeworth Herts CM21 9NB.

16K ZX81 fast machine code space invaders and breakout. £2.50 for cassette: D. M. Gilday, 88 Wookey Hole Road, Wells, Somerset.

UK101 Software for sale, many quality programs, TW Soft, 33 Barnesdale Crescent, Orpington, Kent for details and catalogue.

ACORN ATOM — 1K machine language MINI TEXT EDITOR (suitable for 12K RAM ATOMS). Allows language storage of text on tape with good editing facilities — only £4.00 all inclusive for tape and full documentation — or see for more details. M. Ridley, 19 Sharrose Road, Hooe, Plymouth, Devon.

16K ATARI 400 + Program recorder + 9 games inc Space Invaders and Star Raiders, under warranty till November for just £350. Tel: 01-979 1159.

SUPERBOARD II 8K, cased 48x32, Cegmon, Basic 1, 3 and 4, £200. Tel: Bolton 34886 evenings.

FANTASTIC OFFER 50 PET GAMES for 30.00. 2001, 3000 & 4000 series. 50 assorted games for each of the above models, some with sound, some fantastic graphics, all good fun. State model. Disks or tapes (add £2.50 for tapes) P&P inc. Also some business & misc. programs send sae for details going up to 8096. K.J. Rose, 101, Old Tiverton Rd. Exeter, Devon EX4 6LD. Tel: 0e92-73596.

NORTHSTAR ADVANTAGES Two virtually unused machines (still under warranty), surplus to requirements, for sale. One with one serial port, one with two serial ports. CPM, NorthStar DOS, NorthStar Basic and WordStar also available. £1,850 — unit with one port. £1,925 — unit with two ports. Software — £375.00. Please telephone 01-828 3721 or 722 6075.

8K PET with 24K Petite add-on memory. NEW ROMS, Integral cassette, small keyboard, dust cover, some tapes. £400 R. N. Symington, Coopers Farm, Chiddingly, Lewes BN8 6HD. Tel.: Chiddingly (082583) 237.

ACORN BUILT Atom, 12k + 12k, via, F.Point, regulated PSU 5V3A, leads, manual books, software, cassette, 4 mths old. £250. Tel.: 01-459 6133 (evenings).

FOR SALE, MX80 Type III printer, brand new. Must sell £380. Phone 841-3491 after 6pm.

PET 4032, cassette, dust cover, manuals, etc, under 1 year old, £500. Tel: A. J. Boyle 01-802 9658.

VIDEO GENIE 16K . . . Keyboard/lower case/Sound mods. Acculab Floppy tape. Over £150 in software inc. Basic 4, books manual. £500. R. Beattie. Lincoln 730421 Ext. 423. (day-time).

2 SWTP 6800 systems for sale in working order. Computer +24K £399, CT64 terminal £199, MF68 Twin disk drive. £299. Tel.: 0788 87 629 or 0727 51404.

HP41-CHESS. Knows all rules. Very strong. Very fast. Price 2000 flux (ca. £20). Bank TR.: 332/014507/00 Banque Generale Luxbg. Add. information: Claude Roeltgen, Rue d'Ehlerange 44 L-3918 Mondercange Luxbg.

BBC SOFTWARE CASSETTE No. 1. Lunar Lander and Attack £5.00. Cassette No. 2 Adventure 1 £5.00. Both £9.00. K. P. Hammond, 5 Rodborough Road, Dorridge, Solihull, W. Midlands, B93 8EB.

STATISTICS for the Apple II, 5+ programs for £20. Regression, correlation, latin-sqr, etc. S.a.e. E. Suto, 96 Victoria Ave, HULL.

380Z 32K. Minifloppy. High resolution, graphics, software includes CP/M. £1,500 ono. Oxford 53514 evenings.

16K ZX81 for sale. Excellent condition — approx. 50 programs. Bargain at £80.00. Phone 0504/44991 after 5 pm.

A 6502 Assembler simulator that's as friendly as BASIC! 40 of the most used commands are implemented for the PET 4032. Written in machine code and BASIC, supplied with 25 page users manual and cassette for £20 from Mr. B. Williams, 456, Heol-Las, Birchgrove, Swansea, SA7 9DR. Or call (0792) 781370 for further information.

CENTRONICS P1 Microprinter. Centronics parallel interface 80 cpl vgc. £80. PERSONAL COMPUTER WORLD back issues 1978 to 1982. £10 the lot. HATFIELD 73240.

MATRIX PRINTER. Hydra printer model B. 185 C.P.S. Serial RS232 interface. 132 columns. Upper & lower case. Cost new £1,250. Two yrs old. Good working order. Unused for 9 months. £450. London NW1. Phone 01 723 9777.

TELETYPE ASR33 (tape punch and reader model) one owner from new, regularly serviced. Includes quantity of tapes and complete set of manuals. For quick sale £125. Auto-Route Ltd, Alton (Hants) 0420 62952.

UK101, MISSILE COMMAND, a machine code version, VERSI-MAFS, a general maths program and more! SAE for details N. Johnstone, 59 Copeland Avenue, Mirehouse, Whitehaven, Cumbria.

ALTOS 8000 micro 64K CPU with twin 500K 8" floppies & CP/M. Complete with terminal VDU & OKI printer, business software and some games. A chance to buy a high powered machine for a home computer price. £1,975. Tel: 051 526 7087.

APPLE II plus 48K, disk 3.3, modulator, some disks and software (Gorgon, Asteriods etc). Will deliver free. £800. Telephone Raymond 061 794 5175 evenings.

NASCOM 2 16K, 10 amp psu, graphics, port probe, sargon chess, 'creed printer, 10" monitor, usual extras, hardly used 021-559 8365.

Salmon Microcomputing
0325-721368

SBD Consultants Ltd
01-940 5194

Selven Ltd
0376-40900

Sheffield MIS Ltd
0742-20224

SMG Microcomputers
Gravesend 55813

Software Architects Ltd
01-734-9402

Solitaire Ltd
04252-71448

Southdata Ltd
01-994-6477

Southern Computer Systems
Torquay 212957/8

Spider Software Ltd
01-680-0267

Stage-One Computers Ltd
0202-23570

Stemmos Ltd
01-602-6242

Stratheden Ltd
0624-26668/25639

Style Systems Ltd
0254-71638

SWTPC Ltd
01-491-7507

Systematics International
Microsystems Ltd
0440-61121

T W Computers Ltd
061-456-8187

Taylor Micro Systems
021-358-2436

The Alphabet Company
0304-617209

The Computer Room
0732-355962

Tridata Micros Ltd
021-622-6085

Typestyle Ltd
0624-25890

U-Microcomputers Ltd
Warrington 54117

Vauntberry Ltd
Fareham (0329) 285151

Verwood Systems
0788-87629

Vlasak Electronics Ltd
0494-448633

Wida Software
01-567-6941

Wisbech Computer
Services

Xitan Systems Ltd
0703-38740

PO Box 26 Croft-on-Tees
Darlington DL2 2TN

15 Jocelyn Road
Richmond, Surrey TW9 2TJ

West House Chambers
3 Sandpit Road
Braintree, Essex CM7 7LY

77 Hallam Grange Rise
Sheffield S10 4BE

39 Windmill Street
Gravesend, Kent

34/35 Dean Street
London W1V 5AP

Highcliff House,
411-413 Lymington Road
Highcliff, Dorset BH23 5EN

10 Barley Mow Passage
London W4

7 Park Hill Road, Torquay
Devon

98 Avondale Road
South Croydon
Surrey CR2 6JB

6 Criterion Arcade
Old Christchurch Road
Bournemouth

344 Kensington High St
London W14

Exchange House, 54 Athol Street
Douglas, Isle of Man

28a Railway Road
Darwen, Lancashire BB3 2RG

38 Dover Street
London W1

Cleves House, Hamlet Road
Haverhill, Suffolk

293 London Road
Hazel Grove, Stockport
Greater Manchester

Hamstead Industrial Estate
Old Walsall Road, Great Barr
Birmingham

2 Whitefriars Way, Sandwich
Kent CT13 9AD

87 High Street
Tonbridge, Kent TN9 1RX

Smithfield House, Digbeth
Birmingham B5 6BS

1 Avondale Court
Onchan, Isle of Man

Winstanly Industrial Estate
Long Lane, Warrington
Cheshire

9 Wych Lane, Bridgemary
Gosport, Hampshire PO13 0SU

Verwood House, High Street
West Haddon,
Northamptonshire

Vlasak House, Stuart Road
High Wycombe
Buckinghamshire HP13 6AG

2 Nicholas Gardens
London W5 5HY

10 Market Street, Wisbech
Cambridgeshire PE13 1EX

23 Cumberland Place
Southampton

S J A Still

Susan Ben-David

R Crowther

R A Coates

Richard White

Nick Spicer

N Hewitt

Shibli Abi-Shaheen

P Bridson

R Horman

C A Taylor

A L Minter

Mark Meakings

A Plackowski

M Footitt

P Hayes

N Howard

Paul Vlasak

Ian Duffy

DOUBLE your disk capacity

ONLY £55

KEELE CODES' unique compression utility E40 will compress files written in English to approx 40% of their original size in the same time as it would take to make a copy.

- | | |
|--|--------------------------------------|
| Making backups? | - receiving disc lasts twice as long |
| Archiving a Winchester? | - half as many disc changes |
| Data by telephone? | - powerful archive commands |
| Running out of space? | - halve the cost |
| Computer/ | - double the space you 'see' from |
| computer transfer? | the terminal |
| You don't believe it? - If not satisfied | - part of the package - and twice |
| return within 30 days - we | as fast as a bonus |
| will refund your | |
| money. | |

Proven & Working

Fully developed, E40 is the result of extended research at the University of Keele.

Optimized for English, E40 will compress any text/data files. Numeric or tabular material compresses to about 50%. Database files can come as low as 20%. All 256 ASCII characters are processed, and the decode program faithfully restores the original file.

A third utility transfers E40 files through a serial port.

CP/M formats include - Xerox 820, Superbrain, North Star, Osborne, Z80-Apple, IMS 5000, RAIR, Vector, NEC, Sharp, Heath/Zenith, 8" IBM. Also available for PDPII and GEC 4080 series.

Write or phone for full details



**Keele Codes Limited, University of Keele,
Keele, Staffs ST5 5BG
Tel: 0782 629221
Telex: 36113**

ORDER NOW!

Cut out the coupon
Access accepted. You may phone your order
24 hours service. Guaranteed despatch within 72 hours

Please send me	Tick
E40 for CP/M.....	£55 + VAT (incl postage) <input type="checkbox"/>
CP/M manual.....	£5 <input type="checkbox"/>
Further details.....	<input type="checkbox"/>
Name _____	
Address _____	
I enclose a cheque for _____	Access no _____
My computer is _____	Year of purchase _____

● Circle No. 264

COST CONSCIOUS!

Heralding the beginning of a new age of low cost Word Processing Computer Systems

SMITH CORONA TP-1

- Dedicated Computer Printer
- Microprocessor Controller
- Serial, Parallel or IEEE Interface
- Lowest cost purpose-built Daisywheel



£485
+ VAT

BYTEWRITER

- Keyboard Printer
- Lift off facility
- Built-in self test
- Rigid carrying case



£485
+ VAT

DISCOM TRADING COMPANY
Dresden House, 51 High Street
Evesham, Worcs. WR11 4DA
Telephone (0386) 3591

Further Information Please

Name _____

Address _____

Telephone _____

discom

● Circle No. 265

HANNIBAL

Is the fall of Rome imminent in this game reviewed by Paul Marks?

BRITISH GAMES software is as good as anything from the States. Hannibal is a program by Richard Bodley-Scott for the 16K TRS-80 or Video Genie, consisting of a main program in Basic together with a machine-code section. Back-up copies can be made using CSave for the Basic element, and a short Basic program is included within the written instructions that enables a copy of the machine-code part to be made without the aid of a specialist copying program.

The instructions consist of five pages of explanation plus two one-page appendices which list initial town ownerships and troop deployments. They are clear, and give the player a good idea of the scope of the game. They are slightly more detailed than is absolutely necessary but contrast superbly with the legalese of board-game rules.

The game is for two players, a Roman and a Carthaginian, though it also passes as a solo game for the purposes of working out tactics, etc. The two leaders join in conflict to achieve sole supremacy over the countries surrounding the Mediterranean. Victory occurs when either Rome or Carthage is captured by the opposing side, so a sudden victory is possible if one player can launch a sneak attack against the capital. In practice this is very difficult to achieve.

Machine-code maps

On running, a map of Italy is displayed together with a menu which lists maps of Africa, Sicily, and Spain, and Area Report, Treasury Report, Recruitment, Movement or End as options. The maps are held in the machine code and print virtually instantly, without disturbing any other information on screen.

The problem of having the map split into four is very largely overcome by the speed of printing. Major towns and sea areas are named and movement is from one such feature to an adjacent one. Ports are specified and are accessible to warships and naval transports. These play a very important role, allowing forces to



be rapidly shifted from one front to another.

Area reports list the troops deployed in that area. Many towns start as neutrals but can usually be "persuaded" to join one side. Captured towns can be sacked or just occupied. Sacking yields immediate loot while occupying earns a regular tax income.

Treasury report gives your bank balance. Recruitment is restricted by cash to certain areas and troop types and levels. Eligible troop types are infantry, cavalry, elephants — good for scaring cavalry — warships, transport and artillery.

A player-turn generally moves through recce, recruiting and finally movement. There are three moves to a year and taxes are collected each winter. The order of play is Roman, Carthaginian, Combat, Carthaginian, Roman, Combat, etc.

Some form of combat is mandatory whenever there are opposing forces in the same area during the combat phase. This can be an open battle or a siege if one player is occupying a town.

Combat results in varying losses which can be quite drastic for the loser. Motto — don't fight unless you are going to win. Sieges especially can be nasty if an assault is made rather than just waiting.

Economic war

You can achieve a victory by purely military means if you defeat the enemy in combat. In the longer term you can play an economic strategy by concentrating on the capture of towns, which increases your income and naturally restricts that of your opponent.

Like the Punic Wars the game can go on for a very long time until one side achieves a breakthrough. There are a couple of basic plans, but with numerous variations and with care you can quickly change your strategy. Fortunately you can store a half-played game, although it is fairly addictive and people will often play on to the small hours.

The program makes extensive use of Peeking and Poking and it is not easy to work out exactly what is going on. Given time, it could be done, but there is little point.

One area that could be improved covers the troop disposition information. Each player can obtain complete details of all areas. This could be altered to only allow reports on a limited number of areas, or perhaps only for areas in the vicinity of your own troops. 21

Conclusions

● Hannibal is Richard Bodley-Scott's best effort to date.

● It is one of the very small number of programs that can claim to be both good games and historical simulations.

● Ratings:

Physical quality	Good
Subject complexity	High
Perceived complexity	Low
Play balance	Excellent
Realism	Good
Overall	Excellent

The War Machine is a monthly magazine of reviews of games software from various manufacturers; it also covers game-assistance programs and programming theory. Write to Emjay, 17 Langbank Avenue, Rise Park, Nottingham NG5 5BU, England. Single issue £1.25 (overseas £1.75), annual subscription £13 (overseas £20).

Electronic Brokers

DEC SALE

a selection from our huge stocks

PROCESSORS	
PDP8A 10 1/2" 32KW MDS (NEW)	£1,750
PDP11 1/34A, 128KB MOS	£5,000
PDP11 1/44-CB 256KB CPU, Dual TU58, H9642 Cabinet	£12,750
PDP11 1/45 CPU, 96KW Core, Cab	£7,450
PDP11 1/70 CPU, 512KB MDS, Dual Cab	P.O.A.
PERIPHERALS & OPTIONS	
BC06-S-10 Massbus Cable	£250
BC06-S-15 Massbus Cable	£325
BC11A-08 Unibus Cable	£70
DU11 Synchronous Interface	£525
KMC11A Auxiliary Processor (NEW)	£925
KW11L Real Time Clock	£185
KW11P Programmable Clock	£345
LA34DA KSR Terminal E1A	£425
LA36C JKSRT Terminal 20mA	£450
LA36H JKSRT Terminal E1A	£495
LA120DA KSR Terminal (NEW)	£1,225
LA120RA RD Terminal (NEW)	£885
LA180-ED RD Printer E1A (NEW)	£670
LA180-PD RD Printer-Parallel (NEW)	£495
LP04 900 1pm Drum Printer (NEW)	£5,500
MM8AB 16KW Core (NEW)	£995
PC11A Reader/Punch and control	£925
RK06 Add-on Disk Drive (NEW)	£2,200
RM80-AD Add-on Disk Drive (NEW)	£10,500
SYSTEMS	
RX11-80 Dual Floppy Disk Drive and cti (NEW)	£995
VT50 DECscope Terminal 20mA	£250
VT50 DECscope Terminal E1A	£275
VT52 DECscope Terminal (E1A or 20mA)	£395
VT52 DECscope Terminal (NEW)	£525
VT55 Graphics Terminal	£650
SMFX-MMA-DN 11/24 CPU 256KB, H9645 CAB, 2 x RL02 Disk, KT24, VT100 Console, RSX11M (NEW)	£17,000
11/34 CPU 128KB MDS RL11A 5MB Disk & Ctl RL01A 5MB Disk H960 Cab LA36 Console RSX11M Licence	£8,750
11/44 CPU 256KB MDS Dual TU58, H9642 Cab RK711 28MB Disk & Ctl RK07 28MB Disk LA120 Console RSX11M Licence	£26,300
11/44 UPGRADES complete service offered including supply and installation of 11/44 CPU and trade-in of redundant processor	P.O.A.
11/70 CPU, 512KB MDS, RWM05 Disk Drive and Ctl TVU77 mag tape and cti LA120 Console (NEW)	£78,000

HAZELTINE VDUS NEW SCOOP PURCHASE



Special purchase of Hazeltine 1500 series VDUs — manufacturer's surplus — ALL BRAND NEW BOXED

HAZELTINE 1510 - SAVE £330

- * 24 x 80 Upper/Lower case ASCII
- * 7 x 10 dot matrix * Dual intensity
- * 8 Switch-Selectable baud rates 110/9600 baud
- * Full/Half duplex plus format mode
- * Remote XY Cursor addressing
- * 12" non-glare screen * EIA/20mA Interface

Manufacturer's list price £880

OUR PRICE £550

HAZELTINE 1520 — SAVE £425

All the features of the 1510 plus buffered serial/parallel printer interface. Manufacturer's list price £1050

OUR PRICE £625

Also available — Reconditioned Hazeltine H2000 VDUs @ **£299** while stocks last

All items reconditioned unless otherwise stated
ADD 15% VAT TO ALL PRICES Carriage and Packing extra

Electronic Brokers Ltd., 61/65 Kings Cross Road, London WC1X 9LN. Tel: 01-278 3461. Telex 298694



Electronic Brokers

● Circle No. 267

NEW

Programming the PET/CBM



OFFICIALLY APPROVED BY
COMMODORE

'This book is excellent.'
- Jim Strasma

'Unquestionably the most accurate and comprehensive reference I have seen to date.'
- Jim Butterfield

Bestseller — comprehensive teaching and reference book on all software aspects of Commodores 2000, 3000, 4000 and 8000 microcomputers and peripherals.

Many programs, charts and diagrams. 17 chapters, appendices, and index. Iv + 504 pages. 19 x 26 x 2 1/2 cm. Paperback. ISBN 0 9507650 0 7. Price in UK and Europe £14.90 each (incl. post and heavy-duty packing). LEVEL LTD., PO Box 438, Hampstead, London NW3 1BH. Tel: 01-794 9848. Five or more £12.90 each. Clear plastic cover. Dealer/Bookseller Enquiries invited.

Cut out or copy coupon, or write to:
LEVEL LTD (PC), PO Box 438, Hampstead, London NW3 1BH.
Send copies of Programming the PET/CBM at £14.90 (post free)

I enclose cheque/P.O. for £.....or official order.

NAME

ADDRESS

PC 882

Fast Service — same day despatch

● Circle No. 266

YOUR QUICK-LEARN WAY TO BASIC OR COBOL

IN YOUR OWN HOME, IN YOUR OWN TIME, AT YOUR OWN PACE.

Learn computer programming quickly and easily through the renowned ICS "Open College" system, taking the course at your own pace and in your own time.

Use the famous ICS study texts, backed up by your own expert tutor, and learn computer programming, the proven way, with ICS home study.

- Courses:
- Introduction to Computer Programming
 - Programming in BASIC
 - Programming in COBOL



Approved by CACC



Member of ABCC



ALL DETAILS FREE—SIMPLY RETURN THE COUPON BELOW

Please send me your prospectus on Computer Programming



Name

Address

Post to: Dept 346 X
ICS School of Computer Programming
160 Stewarts Road,
London SW8 4UJ



01 622 9911
(all hours)

● Circle No. 268

Software Released

ASOLV
The Master System

UCSD p-System
(Version 4)

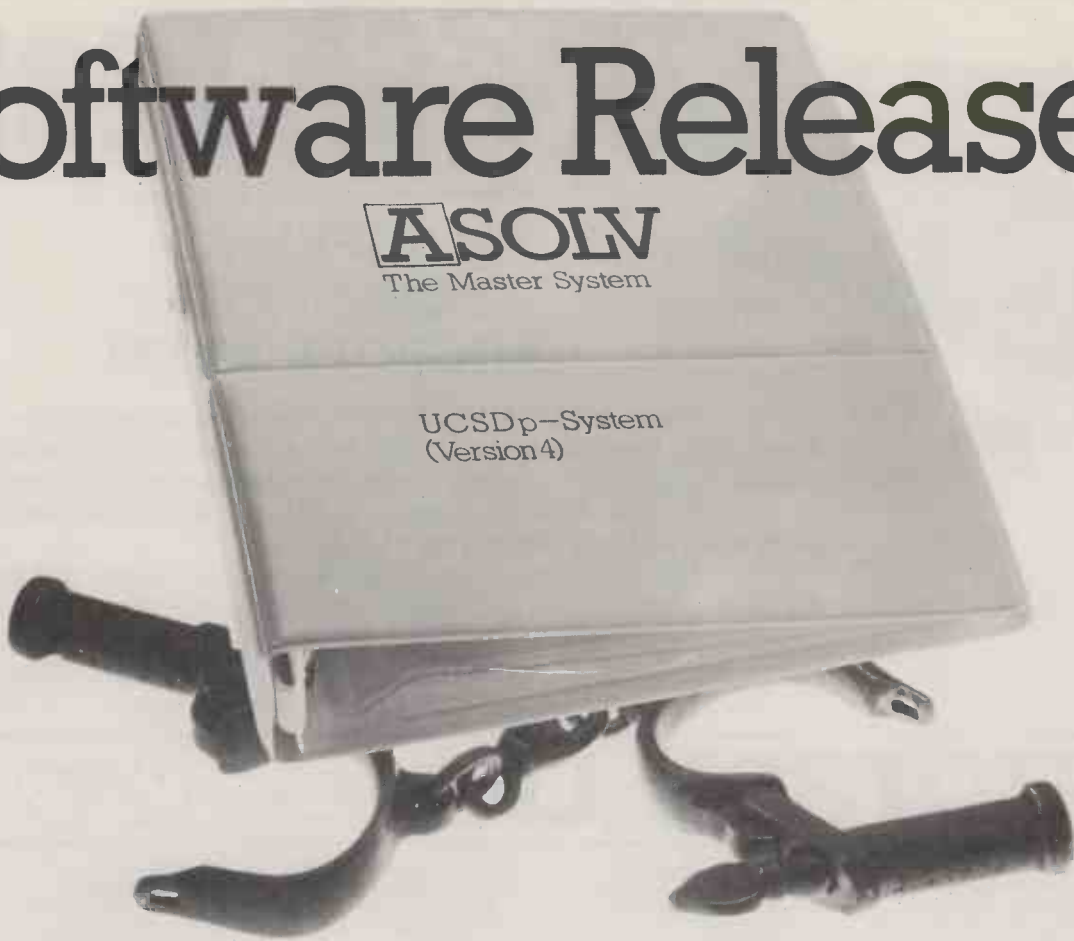

The Hardware Barrier

Whatever microcomputer you own or use its capability has been limited by the availability of software as this is generally designed to run on a specific type of machine. And all too often that important software package has been unavailable on your machine. This restriction has necessitated the benefits of hardware being traded off against software availability with consequent loss in efficiency. Now there's the Master System.

The Key to Freedom – The Master System

The Master System removes the language barrier imposed by a machine giving you total freedom of choice in both software and hardware. So that you can select the software best suited to your needs to run on the machine you prefer. It also means that you can write a program in your choice of languages, confident that it can run on any microcomputer upgraded to the Master System without change or amendment. As a result software can be made more versatile and with a far broader application.

The Master System – Powerful and Comprehensive

The Master System – the UCSD p-System (Version 4) software is the operating system of the future. It comprises a powerful suite of languages including Pascal, Basic, Modula 2 and Fortran and corresponding compilers. Cobol will be available shortly.

Choose your Language

Different computer languages offer different benefits to the user. Such is the Master System's versatility that even a program having modules written in different languages can be run and executed. This allows you to capitalise on the advantages of particular languages avoiding their weaknesses.

An Investment for the Future

With advances in microcomputer technology happening so fast, your major concern is whether your investment in today's technology will be protected in the future. The Master System is designed to give your needs that protection. Software and Hardware houses such as IBM, Apple and ACT Sirius 1 have already adopted the Master System and it is gaining rapid worldwide acceptance. More than 30,000 users have chosen it. Increasingly the Master System will enable you to take advantage of the latest software releases. As your computing needs grow you may outgrow the capacity of your microcomputer, the Master system ensures that your investment in software programs and important data is protected without restricting your future hardware options.

Complete Documentation

The Master System is currently available as a software package comprising a diskette and comprehensive documentation. The Master System is also being built to accommodate Winchester based systems.

For Most Micros

The Master System is available for all 8080/8085 and z80 based microcomputers with the CP/M operating system; including Apple II, ACT Sirius 1, Pet and IBM personal computers.

Please send me further details of the Master System and Master Software.

I am a dealer

I use a microcomputer

Name

Address

Tel. No.

BLOCK CAPITALS PLEASE

ASOLV
The Master System

Asolv Ltd. The Master System. 12-14 Church St.,
Basingstoke, Hants. RG21 1QH. Tel: (0256) 795746.

● Circle No. 269



STAR DP-8480

Manufactured by STAR Co. LTD., Japan

MINIPRICED, MAXISPEED, MICROPRINTER!

The STAR DP-8480 printer is so reliable, our service team are quite bored! It's a friendly printer too, being compatible with the BBC microcomputer, Acorn Atom, Tandy and most other major computers.

And fast! With 80 columns, 80 cps (also 96 and 132 cols.) plus bi-directional, logic-seeking print head.

There's traction feed and friction feed on both the RS232C and the Centronics models and at a price that's almost embarrassing: RS232C with traction feed is £286.15, centronics friction feed is £243.63 and the traction feed version only £267.86 (plus VAT and delivery).

All available from stock so there's no waiting!

STOTRON LTD.

A MEMBER OF THE
ROXBURGH GROUP
OF COMPANIES



STOTRON LTD.,
Haywood Way, Ivyhouse Lane,
Hastings, East Sussex TN35 4PL
Tel: Hastings (0424) 442160 Telex 957066

STOTRON LTD., No. 4A,
Shilton Ind. Estate, Bulkington Rd.,
Shilton, Coventry CV7 9JY
Tel: (0203) 613521

STOTRON (HAYWARDS HEATH) LTD.,
12 Bridge Road, Haywards Heath,
West Sussex RH16 1UA
Tel: (0444) 52550

STOTRON LTD.,
72 Blackheath Road,
Greenwich, London SE10 8DA
Tel: 01-691 2031

● Circle No. 271



We will assist YOU in your DECISION
for Planning, Modelling,
Accounting or Commercial systems

We will support YOU in achieving
the most from your Microcomputer
now, and as your business grows
VISICALC · MICROMODELLER · MICROFINESSE
SALES, PURCHASE AND GENERAL LEDGER
COSTING AND STOCK CONTROL
WORD PROCESSING AND MAILING

For the best professional service contact:
JOHN CHANG, MSc, ACMA
Komputation Automation Information Ltd
203A Belsize Road, London NW6
01-328 7038 & 01-328 3968



AND OTHER GOOD MICROS

● Circle No. 270

EPROM PROGRAMMERS FOR ALL PET VIC ACORN COMPUTERS



- All programmers can read/programme 2716 (2K) 2516 (2K) 2532 (4K) EPROMS and compatible ROMs.
- All you will ever need to make hard copies of your machine code programmes.

- INDEPENDENTLY POWERED
- READ
- PROGRAMME
- VERIFY
- COPY
- CHECK EFFORT IS ERASED
- FULL SOFTWARE TAPE SUPPLIED

£62.00
INC P&P FOR UK

- PET owners — free programme for making your own character generator
- 2716 EPROMS £4.50 inc. P&P
- 2532 EPROMS £8.50 for UK

PET SUPERBOARD 32 £62.00 INC P&P FOR UK

- Select up to 8 ROM/EPROMS from one location.
- NO WIRES, SWITCHES OR SOLDERING ● PLUGS ONTO THE EXPANSION PORT
- EXPANSION PORT STILL AVAILABLE ● SELECT UP TO 8 ROM/EPROMS UNDER PROGRAMME CONTROL ● PLUGS INTO ANY SPARE ROM SOCKET ● POSSIBLE TO RUN A 3KK PROGRAMME FROM ONE ROM LOCATION ● PLUGS INTO THE CHARACTER GENERATOR TO SELECT CHARACTER GENERATOR SETS ● USES 2516, 2716 (2K), 2532 (4K) EPROM/ROMS
- RUN TOOLKIT VISICALC ETC FROM ONE LOCATION a must for all programmers'

ACORN MONITOR CHIP

Please state which location you wish the chip to reside i.e. A000 or D000.

PC	NM1	SR	AC	YR	YR	SP	ENTER MACHINE CODE FROM SCREEN
1000	A000	30	A9	04	60	F0	R = DISPLAY REGISTERS AS SHOWN
							M = DISPLAY MEMORY
:M 1000:1010	A9	FF	20	02	FF	2D	G = EXECUTE RUN ADDRESS
:1000	4C	08	A0	60	00	00	T = MOVE DATA FROM A TO B
:1008							V = VERIFY ANY TAPE PROGRAMMES
:1010							ALSO REPEAT, INSERT, DELETE ETC.

A POWERFUL TOOL FOR MACHINE CODE PROGRAMMERS

VIC USER PORT CONNECTORS AND COVERS £6.50 INC P&P
PET USER/IEEE CONNECTORS AND COVERS. SAE FOR FURTHER DETAILS
ALL OFFICIAL ORDERS WELCOME
PLEASE STATE TYPE AND MODEL OF YOUR COMPUTER WHEN ORDERING

COMPUTER INTERFACE DESIGNS

4 ALBERT RD, MARGATE, KENT CT9 5AW (0843) 294648.

● Circle No. 272

URMSTON COMPUTER CENTRE

Full range of Sharp Microcomputers and peripherals available from stock.
Call in for a demonstration



MZ80B 64K
MZ80A 48K
MZ80K 48K

SHARP
First, and foremost

BOOKS AND SOFTWARE
Competitive Prices!

bar

BAR INSTRUMENT CO. LTD
URMSTON COMPUTER CENTRE
124 Flixton Road, Urmston
Manchester M31 3BG
Telephone: 061 747 4626

● Circle No. 274

COMMODORE COMPUTERS AT ROCK BOTTOM PRICES

ASK THE REST THEN ASK US LAST
WE KNOW WE'RE BEST SO PHONE
US FAST

CBM 8096 £1000	CBM 2031 £330
CBM 4032 £550	CBM 8026 £800
CBM 8032 £680	CBM 8023 £750
CBM 8050 £750	CBM 4022 £330
CBM 4040 £550	All excl VAT

Also cables, ribbons etc. These silly prices must end August



Welsh Computer Centre

MICROCOMPUTER SPECIALISTS

Tremains Road, Bridgend. Phone 0656-2757 or 67996

● Circle No. 273

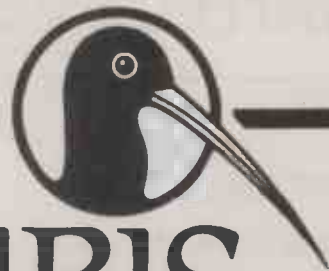

IBIS

SOFTWARE SPECIALISTS FOR

PRACTISING ACCOUNTANTS

- * ACCOUNTS PREPARATION
- * INTEGRATED WORD PROCESSING
- * PAYROLL (BUREAU SYSTEM)
- * TIME RECORDING
- * MANAGEMENT ACCOUNTING

IBIS software for accounting practices is amongst the finest available. But no matter how fine the product, the personal touch cannot be beaten. We provide a friendly service which includes full training of your staff on your premises. Costs typically range from £3,500 to £6,000, including hardware, software and user training.

IBIS software is now available on the

ACT
SIRIUS 1

CP/M Dealer Enquiries
Welcome

Please send me details of IBIS services:

Name

Position

Address

.....

Tel:

IBIS Business Information Systems Ltd,
Parkgate House, Cross Road, Chorlton-cum-Hardy,
Manchester M21 1DH. Tel: 061-881 0585

● Circle No. 275

PROTECT YOUR SOFTWARE INVESTMENT

COPY II PLUS

Apple Copy II Plus gives you the power to make back-up copies of nearly all the "protected" software packages currently available.

INSURANCE

With Copy II Plus you can protect your valuable software investment. Make back-up copies of Visicalc, DB Master, DeskTop Plan, the Apple Special Delivery Software range and many other packages.

RELAX

Copy II Plus allows you to make back-up copies for normal use, so you can keep your originals safely locked away – away from the dangers of spills or stray magnetic fields, or just the wear and tear of everyday usage.

EASILY PAYS FOR ITSELF

While some software companies offer replacement of expensive damaged diskettes, many do not. With Copy II Plus you eliminate the time, expense and worry of costly accidental damage to your valuable software.

FAST

The high-speed option allows you to copy diskettes in less than 45 seconds – faster than any other bit copier – ideal for backing-up your ordinary data disks.

Copy II Plus needs Apple II with 48K, DOS 3.3 and at least one disk drive.

Send £50.00 + VAT to:-
Apple Orchard
1 New Cavendish Street
London W1
or Phone 01-580 5816
and quote your Access
or Diners Club Card



● Circle No. 277



VOTRAX TYPE 'N' TALK

- * Unlimited Vocabulary
- * Built-in microprocessor with text-to-speech algorithm
- * RS232C interface—connects in same circuit as any terminal or runs on its own.
- * Speaks any plain English text that is sent to the terminal
- * Built-in audio amplifier (no speaker)
- * 750 character buffer
- * Band rates to 9600
- * Data echo
- * De-selectable and addressable
- * Phoneme access modes

educational & quantity discounts

PRICE
£275
+ VAT

U.K. Distributor: **INTELLIGENT ARTEFACTS**
Cambridge Road, Orwell, Royston, Herts.
Tel: Cambridge (0223) 207689

● Circle No. 276

Another new CP/M product from Sapphire Systems

SUPERCOM

the most versatile and easy to use COMMUNICATIONS Software Package available for your micro-computer, enabling you to

- exchange files between two micro's
- exchange files between a micro' and a main-frame
- emulate a timesharing terminal on your micro', with an option to transcribe to a disk file
- run your printer at the same time as communicating with a remote computer

SUPERCOM is Super-fast and Super-secure Package including 20-page manual can be yours for only £195 + VAT. Order now from your dealer or contact

Sapphire Systems
19/27 Kents Hill Road
Benfleet, Essex
Telephone: 03745 59756

Dealer enquiries welcome

● Circle No. 278

**BUILD YOUR OWN SPEECH
SYNTHESIZER UTILIZING THE FAMOUS
VOICE CHIP
VOTRAX SPEECH SYNTHESIZER SC-01A**

Parallel Port Speech Board B & T	£99.00
Apple II Plug-in Board B & T	£99.99
P.C.B. (Bare) with Documentations	£29.99
High performance self contained voice synthesizer with parallel and serial ports + P/S + speaker boxed unit AC-101	£29.99
P.C.B. (Bare) + Documentation AC-101	£29.99
Firmware Eprom for AC-101	£6.50
Votrax Speech Chip SC-01A	£39.99
1200 Word dictionary hard copy	£9.99

**BUILD YOUR OWN SOUND GENERATOR
USING THE FAMOUS G.I. CHIP AY-3-8910**

Acorn Atomsound Board Kit	£35.00
Atom Sound Board built and tested	£40.00
Atom Sound P.C.B. + Documentation	£9.99
PET, OSI, UK101, NAS I & II Sound Kit	£35.00
Above Boards Built & Tested	£40.00
Above P.C.B. (Bare) + Documentation	£9.00
Sound Chip AY-3-8910	£5.50
Atom Sound Firmware Eprom	£5.50
Ribbon Cable Connection for PET, OSI, UK101 (plug both end)	£5.50
Power Supply Kit	£12.50
Acorn Atom Expansion Board	£4.99
Special Offer RAM Chip 2114 only	£0.80
For other support chips uP kits such as RAM boards, Eprom Burner Kit, Z80, 6502, 6800 Single Board Micros Kit, Technical Books, etc. Please send self-addressed envelope. Our prices are very reasonable. All ex-stock. VAT extra. Credit cards facilities, technical advice all readily available.	

Easicomp Ltd

57 Parana Court, Sprowston, Norwich NR7 8BH.

● Circle No. 280

ARBOR SUPPLIES

5.25" Diskettes - '10 Packs'

DYSAN - UNBEATABLE QUALITY

Single Sided/Single Density	£24.00
Single Sided/Double Density	£28.00
Double Sided/Double Density	£34.00
Double Sided/'Quad' Density	£50.00

KYBE ACCUTRACK - With Free Library Box

Single Sided/Double Density	£10.00
-----------------------------	--------

BLANK LABEL - Economy for APPLE & PET

Single Sided/Single Density	£15.00
-----------------------------	--------

(PLEASE SPECIFY IF 10 OR 16 SECTOR DISKS REQUIRED)

Disk Storage - 10 DISK CAPACITY

Genuine 'EGLY' Plastic Library Boxes £ 1.90 ea.

Drive Head Cleaning Kits

26 Weekly Cleans for £16.60

All Prices exclude Postage and VAT
UK P&P - Diskettes £0.60 per pack; Library Boxes
£0.50; Head Cleaning Kits £0.60 ea.
VAT is calculated at 15% of total goods + P&P value

Please make Cheque/P.O. payable to ARBOR SUPPLIES
or quote your ACCESS Number

11, CHAMBERLAIN GARDENS, ARBORFIELD CROSS,
NR. READING, BERKS. Tel. (0734) 470174

● Circle No. 279

**ZX Spectrum
20 Programs £6.95**

The ZX Spectrum has brought advanced computing power into your home, The Cambridge Colour Collection, a book of 20 programs, is all you need to make it come alive.

No experience required. Simply enter the programs from the book or load them from tape (£2.95 extra) and run.

Amazing effects. All programs are fully animated using hi-res graphics, colour and sound wherever possible.

Entirely original. None of these programs has ever been published before.

Proven Quality. The author already has 30,000 satisfied purchasers of his book of ZX81 programs.

Hours of entertainment

- **Lunar Landing.** Control the angle of descent and jet thrust to steer the lunar module to a safe landing on the moon's surface.
- **Maze.** Find your way out from the centre of a random maze.
- **Android Nim.** Play the Spectrum at the ancient game of Nim using creatures from outer-space.
- **Biorhythms.** Plot the cycles of your Emotional, Intellectual and Physical activity. Some would say this is not a game at all.

Improve your mind

- **Morse.** A complete morse-code training kit. This program will take a complete beginner to R.A.E. proficiency.
- **Maths.** Adjustable to various levels, this program is an invaluable aid to anyone trying to improve their arithmetic.

Run your life more efficiently

- **Home Accounts.** Keeping track of your finances with this easy-to-use program will enable you to see at a glance where the money goes and plan your spending more effectively.
- **Telephone Address Pad.** Instant access to many pages of information.
- **Calendar.** Displays a 3 month calendar past or future, ideal for planning or tracing past events.

ORDER FORM:

Send Cheque or P.O. with order to:-
Dept. A., Richard Francis Altwasser, 22 Foxhollow, Bar Hill,
Cambridge CB3 8EP

Please send me

- Copies Cambridge Colour Collection Book only £6.95 each.
- Copies Cambridge Colour Collection Book & Cassette £9.90 each

Name: _____

Address: _____

● Circle No. 281

BRAINS GOT THE BLUES?

MicroMods Ltd. HAS THE ANSWER



Products for SuperBrain I or II

FULL SuperBios Compatibility

FULL Intertec Compatibility

FULL SuperBrain Compatibility

ROM to prevent loading wrong Intertec System

Same ROM either machine

£40

SuperBios 1.8

Same DISK either machine

£60

to run on SuperBrain I or II (it IS CP/M))

8" disk interface

Same BOARDS either machine

£195

(Software support by SuperBios)

Winchester interface (Software support by SuperBios) PLUS:

Reformat protection

Fast seeks supported

£215

System load from hard OR floppy

Arbitrary configuration of hard disk

SuperVid (for SuperBrain I only)

provides screen enhancements and alternative character sets

£195

SuperBios includes supporting utilities compiled with PRO-PASCAL

Prices exclude VAT and carriage

SuperBrain is a TM of Intertec Data Systems Corp.
CP/M is a TM of Digital Research Inc.

MicroMods Ltd.

53 Acton Road, Long Eaton,
Nottingham NG10 1FR

Tel: (06076) 64264

● Circle No. 283

Texas Instruments · Apple · Commodore · URC 20 · Sharp

Atari 800 · Books · Atari 400 · Acorn Atom · Games · Knowledgeable staff

· MZ 80B · MZ 80A · Atari 800 · Books

COME AND SEE

ONE OF

LONDON'S LARGEST SELECTION OF PERSONAL COMPUTERS AND SOFTWARE

*The Video
and*

MICRO PALACE

62-64 High Street Kensington W8.
01-937 8587.

● Circle No. 282

Knights T.V. & COMPUTERS

KNIGHTS UNBEATABLE SHARP & ATARI DEALS

DEAL A1 — SHARP MZ-80A with BASIC, PASCAL, FORTH and MACHINE CODE languages plus 100 programs £477

DEAL B1 — SHARP MZ-80B with BASIC, MACHINE CODE and KNIGHTS EASY ASSEMBLER £899

DEAL A4 — Complete MZ-80A system — micro, floppy disk, printer, expansion unit, all cards, cables, manuals etc. £1399

DEAL B11 — Complete MZ-80B system — micro, printer, floppy disk, expansion unit, all cables, cards, manuals etc. £1999

ATARI 1 — ATARI 400 — 16 colours with 8 brightness levels, 4 sound voices, 320 x 192 point definition and 25 programs £255

We guarantee to supply Sharp and Atari at unbeatable prices. All prices exclude VAT but include UK delivery. Write for our latest newsletter, price list and software catalogue. We have hundreds of programs for Sharp and Atari.

KNIGHTS TV AND COMPUTERS

108 Rosemount Place, Aberdeen.
Telephone: (0224) 630526. Telex: 739169 KNIGHT

● Circle No. 284

THE FINEST PRINTER/TYPEWRITER MONEY CAN BUY.

THE CROWN RANIER ONLY £795 + VAT

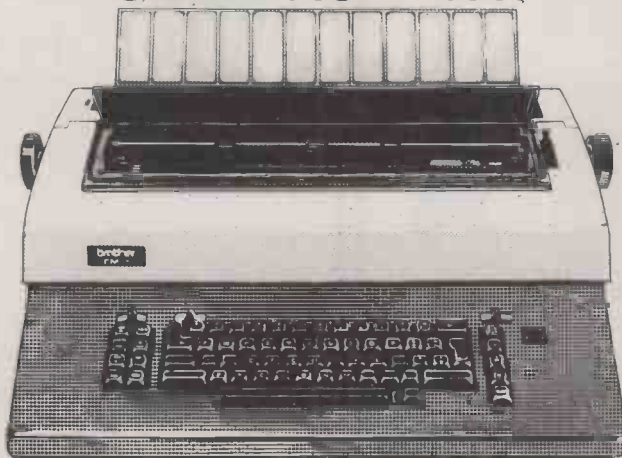

We offer a heavy duty daisy wheel printer/typewriter at the flick of a switch. This machine has the very latest linear motor — no cables or belts to break, stretch or wear. Beware of light weight, low cost machines, these can never give long term reliable service. THIS MACHINE WILL!! Centronics or IEEE interface. Interchangeable daisy wheels — variable pitch — whole line memory. Uses standard type IBM ribbons and lift off correctors. Perfection as a typewriter (used by local authorities). Perfection as a printer.

Ask your local computer or office equipment dealer for further information. EXSTOCK DELIVERY

SOLE UK AGENT. TRADE ENQUIRIES INVITED.



CROWN BUSINESS CENTRE
EASTBOURNE, 56-58 SOUTH ST.,
SUSSEX. (0323) 639983.

● Circle No. 286

WHY YOU NEED LOCKSMITH.

You've invested some money and a lot of time in a commercial software program for your Apple. It works well, to the point that you are *dependent* on its day-to-day functioning. But the disks are copy-protected. So you are also dependent on the vendor's back-up (if furnished), on his living up to vague promises of support, even on his ability to stay in business.

No computer user can live with that. So until the situation changes (and it will), you need Locksmith.

Locksmith (new 4.0 version) will copy almost all "protected" diskettes for the Apple. It is the most reliable nibble-copy program you can buy. *Locksmith is suitable only for backups*, because the copies include all serial numbers, codes and protection features of the original (under the new copyright law, you'd have to be pretty foolish to try bootlegging

software that is traceable back to the purchaser).

Locksmith includes nine other utilities, of which these five are vital to the integrity of your system: 1. Media surface check — Never commit data to a flawed diskette again. 2. Disk-drive speed calibration — the most frequent cause of communication bugs between Apples. 3. Degauss and Erase — Make sure no stray data is left over. 4. Nibble-Editor — sophisticated read/write tool for repairing blown disks. 5. Quickscan — Check for unreliable data, find used and unused tracks.

All for just £65.00 at your local dealer or direct. You don't just need Locksmith. You can't afford to be without it. Access or Visa accepted. Add £1.50 P & P. VAT excluded.

**VERGECOURT
LTD**

17 NOBEL SQ., BASILDON
ESSEX SS13 1LP
TEL (0268) 728484

Apple is a registered trademark of Apple Computer, Inc.

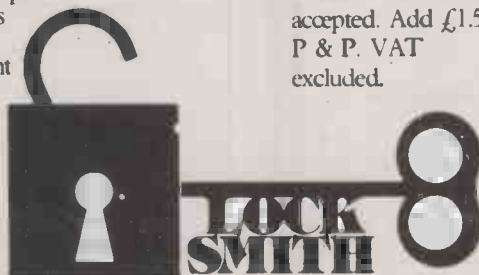

sbd

Software

BEER RUN

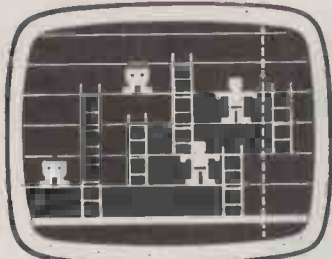

Disk



£19.95

PEGASUS II

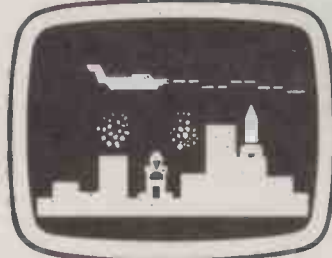

Disk



£17.95

MUMMYS CURSE



Disk



£18.00

COUNTY FAIR



Disk



£16.95

SABOTAGE

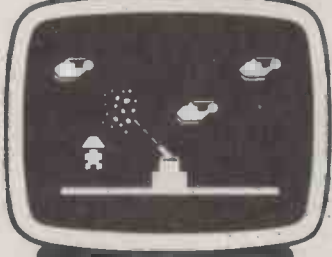

Disk



£12.95

SBD SOFTWARE

15 Jocelyn Road, Richmond TW9 2TJ.

Telephone 01-948 0461

Telex 22861

Please telephone for a full catalogue, or use the coupon provided.
Dealer enquiries are welcome. All prices are plus VAT, postage & packing free.

Name _____

Company _____

Address _____



MORE FROM MICROSOURCE

MICROSOURCE sells mainly APPLE software, peripherals and books. We cannot list all our products in a short space, so look in back issues and other magazines. We can get hold of most of your wants quickly, and at a competitive price. We specialise in the specials, what you need but cannot get elsewhere. Write or ring for a quote or more information — you can't lose!

EPSON OWNERS

Are you an APPLE owner with an MX-80 or MX-100 printer? Are you having trouble using VISICALC, GENERAL MASTER or other such software which conflicts with your EPSON TYPE II interface card?

Then we can help you with a replacement ROM to go on your card which now allows the standard APPLE parallel interface commands to set up your printer correctly. For example CTRL-I 80N will set the column width.

There is no need to POKE numbers into odd locations. The card supports graphics and uses simple commands such as CTRL-16 for default printing of page 1, or CTRL-I GD2 for a double size print of page 2.

Replacement ROM for EPSON TYPE II APPLE INTERFACE CARD . £18

EPSON RIBBON NEED REPLACING?

Do you find it costly replacing the whole cartridge for your MX-80 or MX-100?

We can supply ribbons at £3.10 incl p&p. Fitted in minutes at a fraction of the cost of a new cartridge.

ITT 2020 OWNERS YOU NEED JAILBREAK

COME OUT FROM BEHIND THOSE HI-RES BARS

Now you can run any hi-res program written for your Apple on your 2020 without the annoyance of the 40 vertical bars. Chess and complex games are a joy to behold.

* Saves having to modify programs to 2020 standard (no mean task with complex games which can be over 16K bytes long).

* No soldering required — fit in 5 minutes by following the simple instructions.

* Switchable between APPLE and 2020 nodes.

* Compatible with Apple PASCAL and Microsoft Softcard BASIC.

* Gives 280x192 hi-res dot screen like an APPLE (the 2020 normally gives a 360x192 hi-res dot screen). Text and lo-res are unaffected.

* Does not support hi-res colour. Colours produce various shades of grey on a b&w display.

JAILBREAK incl VAT p&p £33

COSMOS SCREEN MIXER

MIX THE DIFFERENT SCREENS including LO-RES TEXT AND HI-RES to produce completely new effects.

The SCREEN MIXER is a set of modules which replace three ICs on the APPLE II mother board, which allows mixing of any two screens from HGR, HGR2, GR1, GR2, TEXT1 and TEXT2, without software, but under software control. Does not use up any slots.

By mixing HGR screens it is possible to have 560 dot resolution across the screen. You can also have 280 dots of half tone, black or white dots in one line.

COSMOS SCREEN MIXER — including software and manual VAT and p&p £36.50

INTERFACING YOUR APPLE

Two books for extending your APPLE to interface with the outside world.

Apple interfacing by Titus, Larsen and Titus describes circuits and the controlling software in BASIC to allow you to build control devices, monitor external events, build communication devices, etc. After you are taken through the principles of interfacing to the 6502 processor, there is detail on specific problems of interfacing with the APPLE, details of the APPLE I/O ports and then 16 experiments covering Input and Output ports, D to A and A to D conversion etc.

Price including p&p £8.30

ADVANCED 6502 INTERFACING by Holland

Practical guide to design techniques and actual circuits for almost any situation using computer control. Covers I/O port design, serial communications, timers and timing, A to D and D to A conversion, Data acquisition, noise elimination. Includes comprehensive guide to 6502 family including technical specs.

Advanced solutions to complex problems are given in an easily understood manner, with clear and comprehensive explanations. Price including p&p £11.20

To help you make your own cards to fit in the APPLE slots, we can offer

VERO PROTOTYPING BOARDS

Price including p&p £8.50

ALL PRICES INCLUDE VAT UNLESS SPECIFIC MENTION IS MADE. ALL PRICES INCLUDE P&P

MICROSOURCE

1 Branch Road,
Park Street
St. Albans.

Tel: Park Street (0727) 72917

● Circle No. 288

● Circle No. 289

The Arcom range of computer boards

● programmable in BASIC ● Eurocard size



Arc1 single-board computer with BASIC, clock/calendar with battery, RS232 interface, 4K bytes of RAM, 2K demonstration EPROM
£135 + VAT

IOC1 power controller board with four solid-state relays, three triacs, three reed relays, four darlington drivers, and eight opto-isolated inputs
£148 + VAT

Epic1 EPROM programmer for 2K and 4K EPROMS, with relay-switched power, zero insertion force socket, LED indicators and 1200 baud cassette interface
£64 + VAT

PSU2 power supply with toroidal transformer, giving 5V at 1amp, $\pm 12V$ at 200mA, 35V (nom) for EPROM programming
£34 + VAT

All boards (except PSU) can be fitted with a Eurocard or ribbon-cable connector. Please specify.

Carriage and packing - Please add 2% of order value before VAT (minimum £2) (UK only)

Also available

ADA1 8 bit 8 channel A/D converter with differential input amplifiers and DMA, plus 8 bit D/A converter with output amplifier
£138 + VAT

Order from

XZ8 CP/M cross assembler for Z8 code
£140 + VAT
card frame and system hardware - contact Arcom

Arcom

CONTROL SYSTEMS LTD.

37 Grahame Close, Blewbury, Oxon Tel: 0235 850544
 or from HiTek Distribution, Trafalgar Way, Bar Hill, Cambridge Tel: 0954 81996

● Circle No. 291

A complete business computer service from

forte data systems

Introducing the New  **ACT SIRIUS 1**

Minicomputer Performance - Personal Computer Price - 16 bit processor: £2,395

Free consultation - Implementation - Customisation

Forte Data Systems offer a free consultation service to evaluate and discuss your requirements. We will undertake to install systems and provide you with an after sales support service to ensure that you get the full benefit of today's technology.

Systems include:

Word processing . order processing . stock control . invoicing . sales ledger . integrated accounting . management accounts . mailing lists . financial modelling . mainframe communications . databases

Telephone 01-637 0164 to arrange for a demonstration or complete the attached coupon. Callers by appointment only.



To: Forte Data Systems
 27 Rathbone Street, London W1P 1AG
 Tel: 01-637 0164
 PLEASE CONTACT ME WITH FURTHER DETAILS
 Name _____
 Position _____
 Company/address _____

Tel: _____ P.C.8

● Circle No. 290

DISKS & TAPES

- 5 1/4" SSSD BASF £17.95 + VAT
- 5 1/4" DSSD BASF £21.45 + VAT
- 5 1/4" DSSD BASF £25.95 + VAT
- 5 1/4" Cleaning Set £16.50 + VAT
- 5 1/4" Library Case £1.90 + VAT



Cassettes (C20) 65p All storage media is top quality—
No High St. rubbish.

Add £1.50 p. & p. per box.
28 Disk protection folder £10.49 + VAT

NEW! **IN STOCK**
Only **£155 + VAT.** The new colour board from Lucas **now**
nascom
Micro-Spares VALUE

nascom
PRODUCTS

KITS	
Nascom 1, with NAS-SYS 1 less P10	£112.50
Nascom 2, no user RAM	£202.50
BOARD LEVEL	
Nascom 1, with NAS-SYS 1 less P10	£126.00
Nascom 2, no user RAM	£238.50
CASED SYSTEMS	
Nascom 3, no user RAM	£338.40
8K user RAM	£36.00
16K user RAM	£90.50
32K user RAM	£103.50
48K user RAM	£117.00
POWER SUPPLY	
Kit form	£29.95
MEMORY CARDS	
RAM B memory card	
with 16K RAM—kit	£72.00
RAM B memory card	
with 16K RAM board	£80.00
Additional 16K RAM	£13.50
Additional 32K RAM	£27.00
I/O BOARDS	
I/O boards for 3 x P10	
1 x CTC, 1 x UART (kit) ex P10	£40.50
P10 for above I/O	£10.80
CTC for above I/O	£12.80
UART for above I/O	£14.40

SHARP
MZ80K

48K
Computers
unbeatable prices
£315 + VAT
High Resolution
Graphics for MZ80K
£110 + VAT

DISC SYSTEMS	
Nascom single disc drive (350KB) incl. FDC card	£423.00
Nascom dual disc drive (350KB each) incl. FDC card	£616.50
NAS DOS disc op system	£40.50
SOFTWARE	
NAS-SYS 1 ROM	£10.80
NAS-SYS 3 EPROM	£18.00
ZEAP 2.1 for NAS	
SYS in 4 x EPROM	£26.30
ZEAP 2.1 for NAS	
SYS on tape	£22.50
8K microsoft basic in ROM	£18.00

Micro-Spares

SUPPLIERS TO TRADE LOCAL GOVERNMENT EDUCATION INDIVIDUALS INDUSTRY

VALUE

COMPUTERS PERIPHERALS COMPONENTS & MAINTENANCE

19 ROSEBURN TERRACE, EDINBURGH EH12 5NG.
031-337 5611

PAYMENT AND DELIVERY
Payment is by Cheque, Postal Order, ACCESS, VISA etc. PLEASE add postage and VAT. All in stock items sent same day. All non Kit items have a 1 year guarantee.

ALL PRICES APPLY TO END SEPTEMBER 1982

COMPONENTS MEMS
4116 (200nS) 73p
2708 £1.50
2716 (5V RAIL) £2.11
2714L 95p

CONNECTORS
25W plug £1.50
25W socket £1.89
Covers £1.20

TOP VALUE PRINTERS TOP VALUE

Anadex DP8000 B & O Matrix £300 + VAT
Tec 45 & 55 Cps Daisy Wheel £995 + VAT
Silver Reed Typewriter/Printer RS232 £500 + VAT
RICOH RP1600 £1149 + VAT
Triumph-Adler Stylist £595

EPSON PRINTERS
MX80FT—I £307 + VAT
MX80FT—II £315 + VAT
MX80FT—III £327 + VAT
MX100 Type £439 + VAT
MX82FT £330 + VAT

TERMINALS/MONITORS

BMC 12v Green Screen Monitor £119 + VAT
Televideo 910 Terminal £425
Televideo 925 Terminal 525
Televideo 950 Terminal £615

1 YEAR GUARANTEE ON ALL NON KIT ITEMS

GEMINI

The Gemini MultiBoard concept is the logical route to virtually any microcomputer system you care to name. Whether you require a business system, an educational system, a process control system or any other system, there is a combination of MultiBoards to fulfil that function. This concept ensures maximum flexibility and minimal obsolescence. Maintenance and expansion is greatly enhanced by the modular board design. MultiBoard is based on the 80-BUS structure, which is finding increasing acceptance among other British manufacturers; thus broadening the product base.

HARDWARE (BUILT & TESTED)	
GM802 64K RAM card	£140
GM803 EPROM ROM card	£85
GM807 3A PSU	£40
GM808K EPROM programmer	£29.50
GM809 FDC card	£125
GM810K 5A PSU B	£68.50
GM811 250 CPU board	£125
GM812 250 IVC card	£140
GM813 250 CPU&K RAM card	£225
EV814 IEEE 488 card	£140
GM815-1 Single drive disk unit with PSU (350K)	£325
GM815-2 Double drive disk unit with PSU (700K)	£550
GM816 Multi I/O board	£140
GM819 Speech board	£85
GM820 Light Pen	£35
GM821 ASC II keyboard	£57.50
GM824 Gem Dis disassembler/ debugger tape	£30
GM825 Gem Dis disassembler/ debugger tape	£30
GM826 Comal-80 tape	£100
GM827 Comal-80 disk	£100
GM828 APL disk	£200



THE GALAXY COMPUTER FOR BUSINESS ETC

Hardware
*Twin Z80A CP/M System
*64K Dynamic RAM
*800K Disk Storage (Formatted)
*80 x 255 Screen Format
*Inverse Video

Software
*Full 64K CP/M 3.2 with screen edit facility
*Comal-80 structured BASIC

***Prog. Character Generator**
*160 x 75 Pixel Graphics
*Centronics Parallel I/O
*RS232 I/O
*Light pen interface
*59 Key ASCII Keyboard

***GEM-ZAP Assembler/Editor**
*GEM-PEN Text editor
*GEM-DE BUG debugging software

Galaxy System £1450 + VAT
Green Screen Monitor £117 + VAT

● Circle No. 292

MICRO-80

UK Subscription Dept.

24 Woodhill Park Pembury Tunbridge Wells Kent TN2 4NW

LOOK what you get when you subscribe to MICRO-80 the monthly magazine for TRS-80 and Video Genie. Now in the 3rd year of publication!
All new subscribers (and existing ones when they renew) receive free of charge a Software Cassette complete with 62 page user manual featuring

- ★ **Level I in Level II** - Convert your Level II TRS-80 to operate as a Level I machine.
- ★ **Copier** - Copies Level II System tapes, irrespective of where they load in memory.
- ★ **Z80 MON** - A low memory, machine language monitor.
- ★ **Improved Household Accounts** - Powerful enough to be used by a small business.
- ★ **80 Composer** - A music generating program.
- ★ **Plus Two Games** - Poker and Cube (a version of the Rubiks cube for Disk users).

Order just the magazine or take it each month complete with the published programs ready-to-load on cassette or disk.

Please enrol me for an annual subscription and send me my FREE cassette program. I enclose £16.00 (magazine only) or £43.60 (magazine and cassette edition) or £75.00 (magazine and disk edition).
(Enclose your cheque/P.O. made payable to MICRO-80 and send to the above address.)
Software offer, and prices apply to U.K. residents only. Overseas subscription rates on application.

Name

BLOCK CAPITALS PLEASE

Address

.....

PC 8/82

● Circle No. 261

BYTESHOP

Your specialist computer store

A member of the Comart Group



329 Euston Road, London NW1 3BG.

01-387-0505

Are you uncertain what computer system you need? Are you sure you need a computer? Why not come along to one of our seminars or demonstrations and see what we have to show you. We can supply computers from £200 to £20,000 plus. Full installation and service support.

ALL PRICES EXCEPT VIC ITEMS EXCLUDE VAT.

EPSON

Full range inc the new type S ideal printer for almost any system. Also buffered interfaces 8-32K
PRICES FROM £315.00

OSBORNE

We can supply with a Daisy-wheel printer for only **£1,749.00**
This must be the cheapest word-star based word pro system.

VIC-20

If you buy a VIC + cassette deck we give you
FREE worth
Intro to basic 14.95
Games tapes 19.95
10 C12 tapes 5.00

DISKS

Low prices
Wabash
5 1/4" SSSD 17.00
5 1/4" DSDD 24.95
Boxes (10)
2 YEAR G/TEE

apple computer inc.

Full Range
Apple IC
+
Apple 111
with the new access data base from Spider Software

● Circle No. 294

MICRO WORK STATIONS

A new concept in work stations designed to solve space and mobility problems.



A compact storage unit able to house a full system yet only occupying a space just larger than a 60cm square. Even packed away the equipment can still be used effectively.



Opening the hinged leaf doubles the work surface area creating an operating position with ample knee and leg room.

Write or phone for full details to:-
Crowther-Cosine,

**6, Middleton Road, Whittington,
Lichfield, Staffs. WS14 9NB.**

Tel. (0543) 432376

● Circle No. 293

EXTRAS FOR THE BBC

all cassette based

- > "MEDMON-B" MACHINE CODE MONITOR — 20 Commands — Dissassemble, Memchange, Break-points, etc. **£9.95**
- > "MEDTED-B" FREE FORMAT TEXT FILE GEN/EDITOR — including:
"MEDMAIL-B" MAILSHOT LABEL PRINTER **£9.50**
- > "MEDPROM-B" EPROM PROGRAMMER — Machine Code software — Programs 2516/2716/2532/2732 **£79.00**

AND FOR THE PET

cassette or disk

- > "MEDTED-P" FREE FORMAT TEXT FILE GEN/EDITOR — including:
"MEDMAIL-P" MAILSHOT LABEL PRINTER **£9.50**
 - > "MEDDEV-P" CASSETTE OR DISK FILE BASED DEVELOPMENT PACKAGE — Assembler and Offset Loader **£19.75**
 - > "MEDPROM-P" EPROM PROGRAMMER — spec. as "MEDPROM-B" **£79.00**
- For PET specify Model Type and Screen Size.
PET programs on Disk add £2 per order.



Microtrol Engineering Design Ltd.
640 Melton Rd, Thurmaston,
Leicester LE4 8BB.
Tel.: 0533 704492

● Circle No. 295

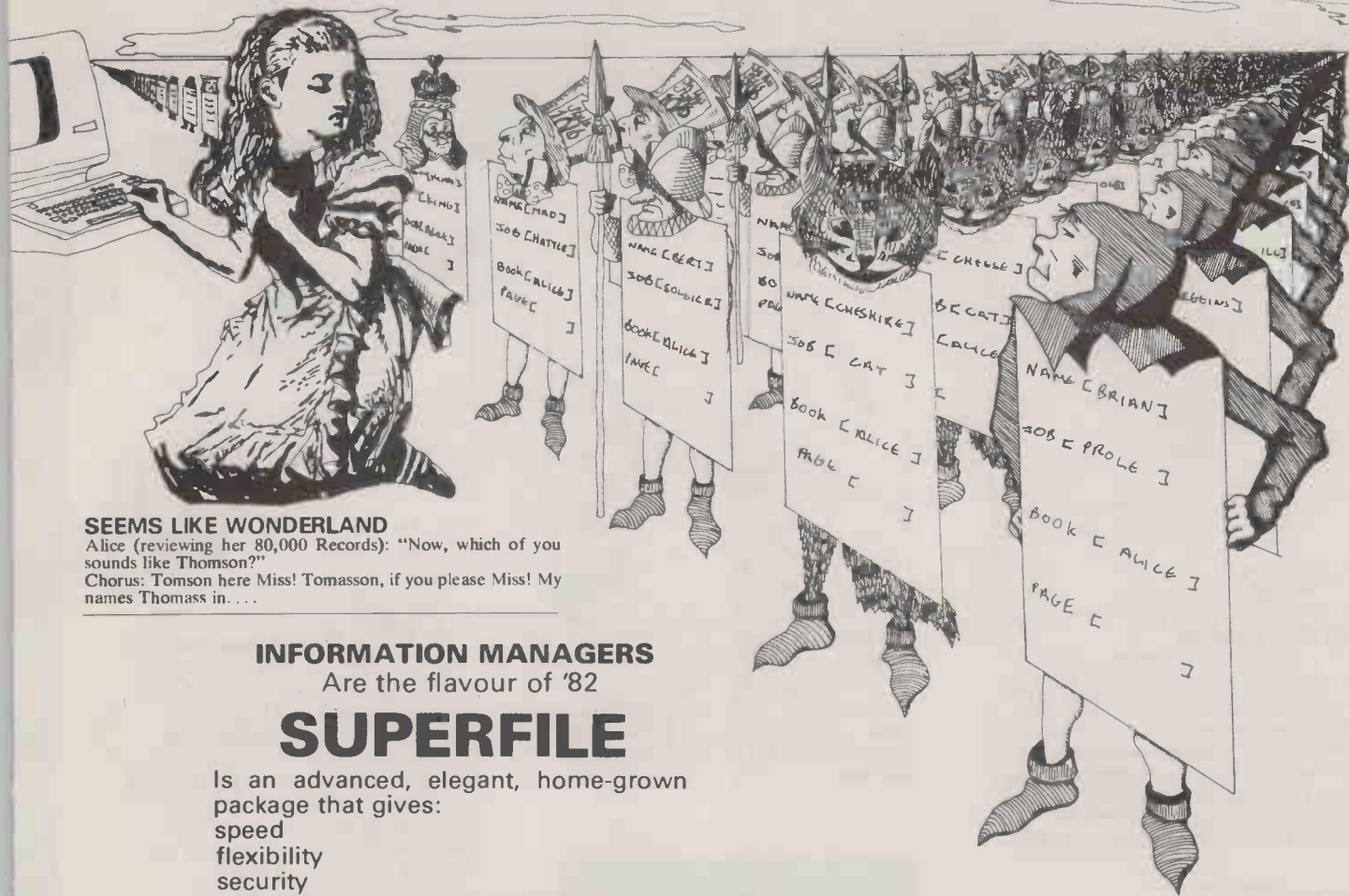

SEEMS LIKE WONDERLAND

Alice (reviewing her 80,000 Records): "Now, which of you sounds like Thomson?"
 Chorus: Tomson here Miss! Tomasson, if you please Miss! My names Thomass in....

INFORMATION MANAGERS
 Are the flavour of '82

SUPERFILE

Is an advanced, elegant, home-grown package that gives:
 speed
 flexibility
 security
 unique phonetic matching
 an interface to any CP/M language
 multi-user capability (the first in the world)

SUPERFILE is a 12K package in Z80 code for any CP/M machine — Xerox, Apple (with Z80 card), Osborne, Superbrain,; multi-user on Equinox under Turbodos, DC4 under MP/M etc.

Two advanced end-user packages are available: SUPERFORMS lets the non-specialist design, store and use screen Forms to enter information, retrieve it and do calculations. Half a dozen Forms — which take only an hour to set up — can do all a small company's book keeping. Tailored software at package prices! SUPERTAB for tabulated Reports, address labels, Mail Merge compatible files. (Ready June 1982)

One-off prices:

SUPERFILE	£175
MULTI-USER	800
SUPERFORMS	75
SUPERTAB	75
DEMO DISK	20
MANUAL ALONE	10

Software dealers:

A BRITISH
 (and much better)
ALTERNATIVE

Are you sick of having to say: "I'm very sorry — they're stuck at the airport" "I'm very sorry — we'll get on to California right away" "I'm very sorry — we'll ring you next week"

If you could do without:

- Slow deliveries
- Poor support
- High prices
- User-hostile software
- Then you might try calling Southdata.

We can give you:

- Immediate deliveries
- Instant support
- Low Prices
- Terrific Discounts

Remember — the SUPERFILE package gives you Tailored Software at Package Prices.

Southdata Ltd

10 Barley Mow Passage, London W4 4PH
 01-994 6477 Telex 8811418

● Circle No. 298



ZX-81

ZX-80

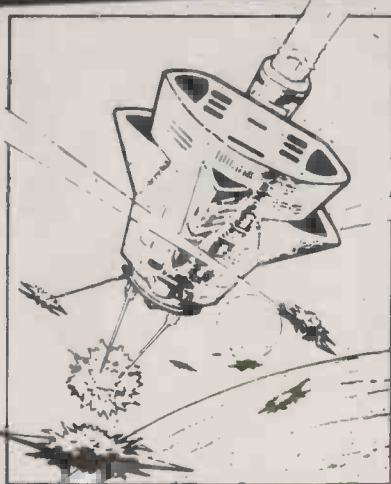

QS DEFENDER.

UP - DOWN - THRUST - FIRE
First and only full screen display. Software to drive QS SOUND BD. Moving Planetary surface. Up to 84 fast moving characters on screen at once. On screen scoring. Ten missiles at once. Increasing attack patterns. Requires 8K ROM, and 4K min of RAM. **£5.50.**

QS SOUND BD.

A programmable sound effects board using the AY-3-8910. 3 TONES; 1 NOISE; ENVELOPE SHAPER. + TWO 8 BIT I/O PORTS. Easily programmable from BASIC, the AY chip does most of the work leaving your computer free for other things. Signal O/P via 3.5 mm Jack socket Ports O/P via a 16 pin I.C. Socket. **£26.00.**

QS CHRS BD./

A programmable character generator giving - 128 SEPARATELY PROGRAMMABLE CHARACTERS. ON/OFF SWITCH. 1K ON BOARD RAM. Enables creation and display of your own characters to screen or printer. Demo cassette of fast machine code operation routines and lower case alphabet included. See below for ZX PRINTER listing. **£26.00.**

QS - LOWER CASE

abcdefghijklmnopqrstuvwxz

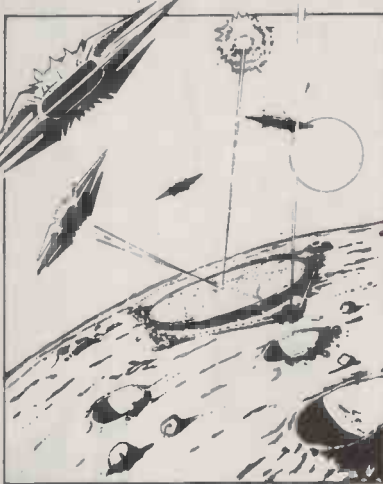

QS INVADERS.

LEFT - RIGHT - FIRE
13x7 INVADERS; High score; 3 levels of play; RND saucers; Bonus base; Drives Sound bd. & CHRS bd. Requires 7K RAM, 8K ROM + Slow. **£5.50.**

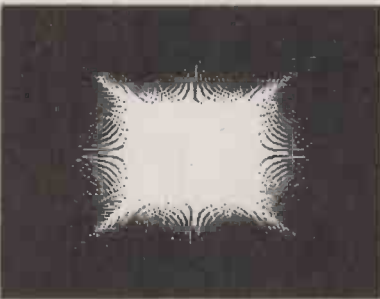

QS HI-RES BD.

A Hi-res graphics board giving - 256 x 192 PIXELS. 6K ON BD. RAM. SOFTWARE SELECT/ DESELECT. MIXED TEXT AND GRAPHICS. 2K ON BOARD ROM. Resident fast machine code graphics software (in ROM) provides the following HI-RES Commands. - MOVE x, y; PLOT x, y; DRAW x, y; BOX x, y; UP; DOWN; LEFT; RIGHT; PRINT A\$; SCROLL; BLACK; WHITE CLEAR COPY. See above for ZX PRINTER listings using COPY. **£55.00.**



QS ASTEROIDS.

LEFT - RIGHT - THRUST - FIRE
Software to drive QS SOUND BD. Multiple missiles firing in 8 directions. On screen scoring. Increasing number of asteroids. Full mobility of ship to all areas of the screen. Two asteroid sizes. Bonus ship at 10,000 points. Requires 8K ROM, 4K min of RAM + SLOW function. **£5.50.**

QS 3K RAM Bd.

An extremely reliable static RAM Bd. which combines with the computer's memory to give 4K total. Plugs direct in to the rear port on your ZX Computer. **£15.00.**

QS MOTHER BOARD BD. & QS CONNECTOR.

A reliable expansion system allowing a total of any RAM pack plus two other plug in boards to be in use at once. On board 5V regulator drives all external boards. Fitted with two 23 way double sided edge connectors. Connector is 2x23 way edge conns soldered back to back. Expansion can operate in two ways - (1) COMPUTER ↔ CONNECTOR ↔ Any QS add on bd. (but no extra RAM pack). (2) COMPUTER ↔ CONNECTOR ↔ MOTHER BD ↔ ANY RAM PACK. (2 bds to fit in mother bd.) Mother board **£12.00** Connector **£4.00.**

Special offers & news

(1) QS Mother bd. + connector + CHRS bd. + The special Graphics version of **ARCTIC COMPUTING'S ZX CHESS 11. £45.00.**
The strongest chess program with 7 levels of play.

(2) QS MOTHER BD + CONNECTOR + either SOUND or CHRS bd. **£40.00.**

202

STOP PRESS

New Game, QS Scramble £5.50

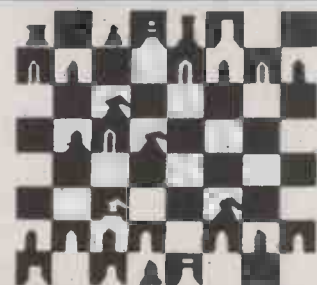

POSTAL AND MONEY ORDERS TO:

QUICKSILVA: 95, UPPER BROWN HILL RD. : MAYBUSH : SOTON : HANTS : ENGLAND.

Please state Type of machine, Which ROM, Memory size, when ordering.

ALL PRODUCTS FULLY GUARANTEED.

THE EUROPEAN

COMPUTER TRADE FORUM

Helping you make money, not mistakes

You could be a distributor, a dealer, a software house, a systems integrator, a sales and service company, a retailer—even a DP man about to go into business on your own. You could know the DP/WP business backwards, or you could be coming into the ring for the first time.

But whatever your status, if you owe your livelihood to buying and reselling computers, software or peripherals, you owe it to yourself to visit ECTF at the NEC this Autumn.

ECTF means business

Because it has been specially created for you, it's the computer industry's own trade show. It has been designed to provide you with a wider range of real business opportunities—*together under one roof.*

ECTF is there to help you plan the most profitable product line, to get the best hardware and software and to negotiate the most advantageous trade deals. Quite simply, your visit could be crucial to your *future business success.*

Seeing, hearing...and comparing

Wang, DEC, Sony, Olivetti, ICL, Hewlett-Packard, Toshiba—a host of household names will be there, plus many names you may not know: new companies in the market with new products that could be next year's big money makers.

They all need to meet you. They'll want to talk trade terms, marketing support, dealerships, discounts

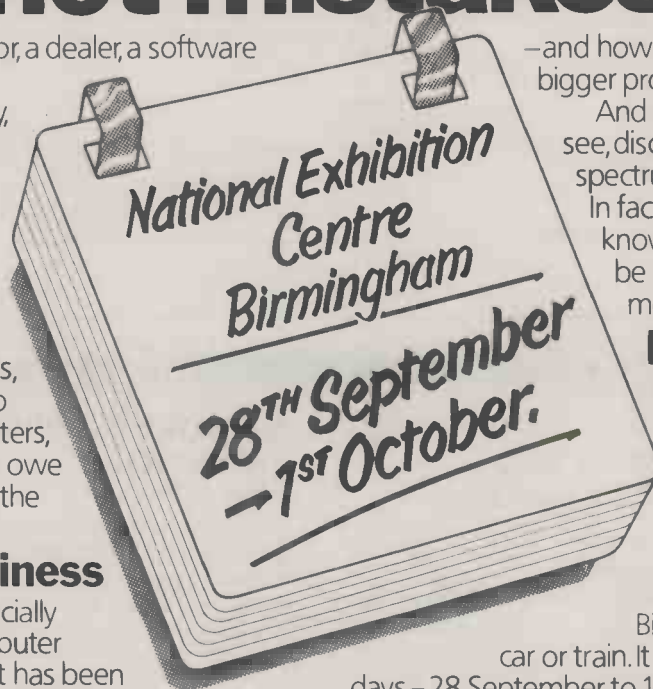

—and how their products can mean bigger profits for you.

And you need to meet them to see, discuss and compare the whole spectrum of WP and DP products. In fact that's the key to ECTF. By knowing what's available, you'll be in a better position to make money...and avoid mistakes.

For trade and trade alone

The general public are not invited to ECTF. The emphasis is on business. And for you it's free.

It takes place at the National Exhibition Centre Birmingham, easily reached by

car or train. It will be open for just four

days—28 September to 1 October. Fill in the coupon and send it to ECTF, 232 Acton Lane, London W4 5DL—or telephone 01-747 3131 and we'll mail you FREE tickets for you and your business colleagues.

**INTERESTED IN EXHIBITING?
PHONE MIKE RUSBRIDGE ON 01-747 3131**

PLEASE FILL OUT AND USE CAPITAL LETTERS

Please send me ___ Free Entrance Tickets for my colleagues and myself.

Name _____

Company _____

Address _____

Telephone _____ Telex _____

(No one under 18 will be admitted)

I would like to receive information on exhibiting at ECTF. Phone me on _____



PC 217

● Circle No. 263

ARE YOU A ZX81 USER WHO'S NOT PLAYING GAMES?



£47.50
Including VAT.
complete

ECR 81 DATA RECORDER SAVES AND LOADS YOUR PROGRAMS EVERY TIME!

The ECR81 Enhanced Certified Recorder from MONOLITH is a major advancement in cassette recorder technology which minimises the problems associated with standard audio recorders. The unit is a high reliability program store for ZX computers based on a modified, proven cassette mechanism. The two sections of data recording circuitry automatically ensure precise levels are written onto the tape and that optimised signals are received by the computer.

**THE ECR81 IS NOT SUITABLE FOR AUDIO REPRODUCTION
NO MANUAL VOLUME OR TONE CONTROL ADJUSTMENT PROVIDED**

- Each ECR81 comes complete with its own individual certification tape, tested and serial numbered to prove your machine reliability.
 - Mains Operation only.
 - Mains & DIN connector leads provided.
 - Certification of tape head alignment - height and azimuth.
 - Certified tape tension, torque and speed.
 - Fast forward and rewind tape search controls.
- The ECR81 is also suitable for Sinclair ZX80
- Please allow up to 28 days delivery. ● The ECR81 is backed by our 14 day money-back option.

MONOLITH
electronic products
Telephone: Crewkerne 0460 74321 Telex: 46306

To: MONOLITH ELECTRONICS CO. LTD., 5/7 CHURCH STREET, CREWKERNE, SOMERSET

Please supply me with:	Price	Total
.....(Qty.) Monolith ECR 81 Enhanced Certified Recorder(s) to be used with my ZX81	£47.50 (Each)	
I also enclose postage & packing per recorder	£2.50	
		£

Please print

Prices include VAT

Name: Mr/Mrs/Miss. _____
Address _____

● Circle No. 313

NEW BOOK

ALSO OF INTEREST

INTERFACING TO MICROPROCESSORS AND MICROCOMPUTERS Owen Bishop

Full constructional details given
Projects work with any system

Consists of a series of practical projects for the home constructor showing how a micro system may be linked to the world around it, e.g. light sensor or sound effects generator. The theory and circuits of each interface are fully explained.

Owen Bishop gives full constructional details, strip-board layouts, lists of components and hints on alignment and trouble-shooting. Also included are flowcharts and suggestions for methods of programming the system to operate with the interface.

Using this book, a wide variety of interfaces can be constructed to suit almost any microprocessor or microcomputer system.

0 408 01129 7 160 pages £4.95

MICROPROCESSORS FOR INDUSTRY

J N W Baldwin

The microprocessor has recently brought computerised control systems within the budget of many small businesses. J N Baldwin has had nearly twenty five years' experience of applying computers to industry; his book explains the capabilities and limitations of microprocessors, the advantages and pitfalls in their application and the general scope for applying this new technology in industry. The book will help anyone already trained in hydraulic or electromechanical technology to catch up on twenty years of development in electronics and take profitable advantage of the microprocessor's potential.

0 408 00517 3 144 pages £7.50

ORDER NOW from your local bookseller
In case of difficulty this advertisement can be returned to Patricia Davies at the address below

Please send me _____ copy/ies of
Interfacing to Microprocessors and Microcomputers
(Bishop) 0 408 01129 7 £4.95
Microprocessors for Industry (Baldwin) 0 408 00517 3 £7.50

I enclose a cheque/PO for £ _____ in total payment

From _____

Address _____

Newnes Technical Books
a division of Butterworths Borough Green, Sevenoaks, Kent TN15 8PH

(PC 8/82)

● Circle No. 262

HOW TO GET MORE FROM YOUR MICRO

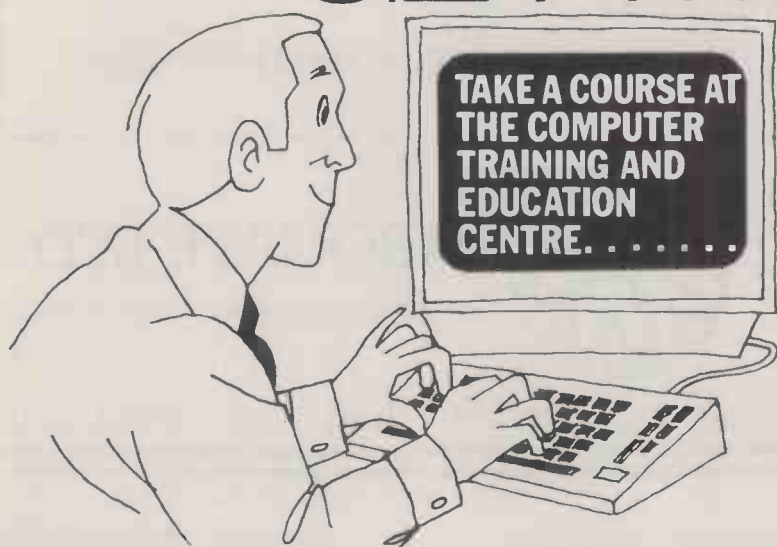

CP/M* (User level)

2 days

A practical course designed for those unfamiliar with CP/M, familiarising the new user with the operation of the typical hardware attached to a disc-based Z80 microprocessor system; and giving an understanding of the facilities available and of its management of disc files.

Advanced CP/M

2 days

This course is designed for those who wish to modify the standard CP/M operating system and includes a detailed investigation of BIOS and its interaction with CCP and BDOS. Previous assembler experience is essential.

Programming in BASIC

1 week

Giving a thorough understanding of the BASIC language and enabling the student to put this knowledge into practical use, facilitated by hands-on sessions and practical exercises.

Programming in PASCAL

3 days

Giving an understanding of structured programming techniques as used in PASCAL and providing practical experience on a microcomputer.

Wordstar† Wordprocessing

2 days

Giving the user an understanding of the facilities available in the Wordstar/Mailmerge Wordprocessing System and hands-on experience which enables this knowledge to be put to practical use.

All courses are in London. A wide range of hardware is available for practical work.

Contact The Courses Secretary, Computer Training & Education Centre Ltd, 102-108 Clerkenwell Road, London EC1. 01-251 4010/4019.

CTEC

A professional organisation with first class training facilities in Central London.

*CP/M is the T/M of Digital Research Corp.

†Wordstar is the T/M of Micropro Corp.

Please send me further information on the course(s) about.....

Name.....

Position.....

Company.....

Address.....

Tel. No.....

PC8

● Circle No. 300

CROMIX USERS.....

Jarogate Ltd. offer the JD12 and JD24 giving 12 or 24 M byte (formatted) storage capacity using Rodime 5¼ inch British made Winchester disc drives. Prices of £2295 and £3435 respectively include S100 controller, case, power supply and Cromix drivers.

Also available as an alternative to the Cromemco HDD-11, the Jarogate JDD-11 provides the same IMI 7710 drive in a more attractive cabinet at £3355.

Tape Backup System: 24 M byte capacity £2295.

Jarogate Ltd. are main dealers for Comart, Cromemco and North Star ranges of systems and boards.

For Hardware, Software, Consultancy and Maintenance.

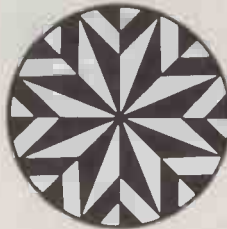

JAROGATE LTD.
the microprocessor consultants

197-213 Lyham Road, Brixton, London SW2 5PY Telephone 01-671 6321

Cromix is a registered trade mark of CROMEMCO INC.

● Circle No. 302

i research ltd.

BABY PLUTO

320 (H) × 288 (V) × 8 COLOUR DISPLAY

The power and performance of Pluto but with 96Kbytes of memory and half the resolution. An ideal match for low cost colour monitors.

Incredible value at only £299 + VAT

A/D BOARD FOR NASCOM

- 8 input channels
- 30 microsec conversion
- Over voltage protection
- Prototyping area
- 8 bit resolution
- Sample and hold
- Full flat/interrupt control
- NASBUS compatible

Price £120 + 15% VAT (post free)

EPROM PROGRAMMER

- Programs 3 rail: 2708/2716
- Single rail: 2508/2758, 2516/2716, 2532/2732
- Software supplied for Read/Program/Verify
- Can be used with other machines with 2 parallel ports

Price £63 + 15% VAT (post free)

6 Laleham Avenue, Mill Hill,
London NW7 3HL
Tel: 01-959 0106

● Circle No. 301

i research ltd.

"PLUTO" COLOUR GRAPHICS PROCESSOR

Pluto is a self-contained colour display processor on an 8" x 8" NASBUS and 80-BUS compatible card featuring:

- Own 16 bit microprocessor
- 1192 Kbytes of dual-ported display memory for fast flicker-free screen updates. (Outside of the host address space).
- 640(H) x 288(V) x 3 planes (8 colours) - 2 screenfulls
OR
640(H) x 576(V) x 3 planes (optional extra)
- Fast parallel I/O interface usable with ALMOST ANY MICRO. Only single +5v supply required.

Pluto executes on-board firmware providing high level functions such as:

- Fast vector draw - over 100,000 pixels/sec. Lines can be drawn using REPLACE, XOR, AND, OR functions
- User-definable characters or symbols
- Spare display memory with memory management facilities for allocating symbol storage space or workspace
- Rectangle Fill and copy using REPLACE, XOR, AND, OR plus 5 other functions
- Fast access to single pixels
- Write protect memory planes during copy
- Double-buffered screen memory for animated displays
- Complex polygon colour fill

Pluto is expandable. An expansion board will be available later this year to give Pluto up to 8 memory planes with no loss of resolution. S100 Interface now available.

AVAILABLE NOW. ONLY £399 + VAT (p&p free)
Dealer and OEM enquiries invited.

6 Laleham Avenue, Mill Hill,
London NW7 3HL
Tel: 01-959 0106

● Circle No. 303

PRO PASCAL — THE MODERN WAY TO PROGRAM

Pascal provides the user with means of structuring both data and code. Pro Pascal is a true compiler, generating programs which make full use of the registers and instructions of the Z80 processor.

- Superset of ISO Standard Pascal
 - Fast, compact object code — see published benchmarks
 - Separate compilation facility allows large programs to be subdivided into manageable segments
 - For Business applications:
 - nine-digit integers (32 bits)
 - string handling
 - sequential and random access to files
 - For scientific use:
 - single (32-bit) and double (64-bit) precision real values
 - input/output and all math functions in both precisions
 - For systems programmers:
 - object programs can incorporate assembler-coded modules
 - compiled code is reentrant (ROMable)
- Pro Pascal runs on any Z80 micro with CP/M and at least 52K RAM, for instance:
 - Apple + Softcard
 - Clenlo Conqueror
 - Cromemco (with CP/M or CDOS)
 - Digo Prince
 - Gemini Galaxy
 - Heath/Zenith Z89
 - Nascom
 - NEC PC8000
 - North Star Horizon & Advantage
 - Pet + Softbox
 - Research Machines 380Z
 - Sharp MZ-80B
 - Superbrain
 - TeleVideo
 - Vector MZ
 - Xerox 820
 - Zilog MCZ

Pro Pascal is developed and supported in the UK. The single-user price is £190 plus VAT. The software package includes disc-to-disc linker and a cross-reference generator.

Prospero PROGRAMMING LANGUAGE SPECIALISTS

Prospero Software, 37 Gwendolen Avenue, London SW15 6EP Tel: 01-785 6848

● Circle No. 305

The Micronex 128S £675.

High resolution display generator 2 pages x 1024 x 512 pixels

Hardcopy printer output facility £55.
IDS PT560 & Prism 132 printer drivers

Digitiser pad input facility £55.
Graphics primitive handlers for
Summagraphics Bit-Pad
and Houston Hi-Pad

PLUS suite of 5 software
packages £395.

For Pascal, FORTRAN, BASIC
under CP/M include —
Graphics Primitives, Graph
Plotter Surface Plotter in 3D with true-perspective
and hidden-line removal. 3D graphics for
wire-frame objects. Tektronix 4010/4014 graphics
terminal emulator

FAST ACCESS

The exclusive Micronex VU-DISK £115.

Lets you use your Micronex 128S Pixelplotter just like a
very-fast-access 128K byte disk under CP/M.
Eliminates time consuming disk-drive activity.
Up to three times faster for sorting, merging,
compilation, assembly

High resolution graphics
packages for the Superbrain 1
& Superbrain 2

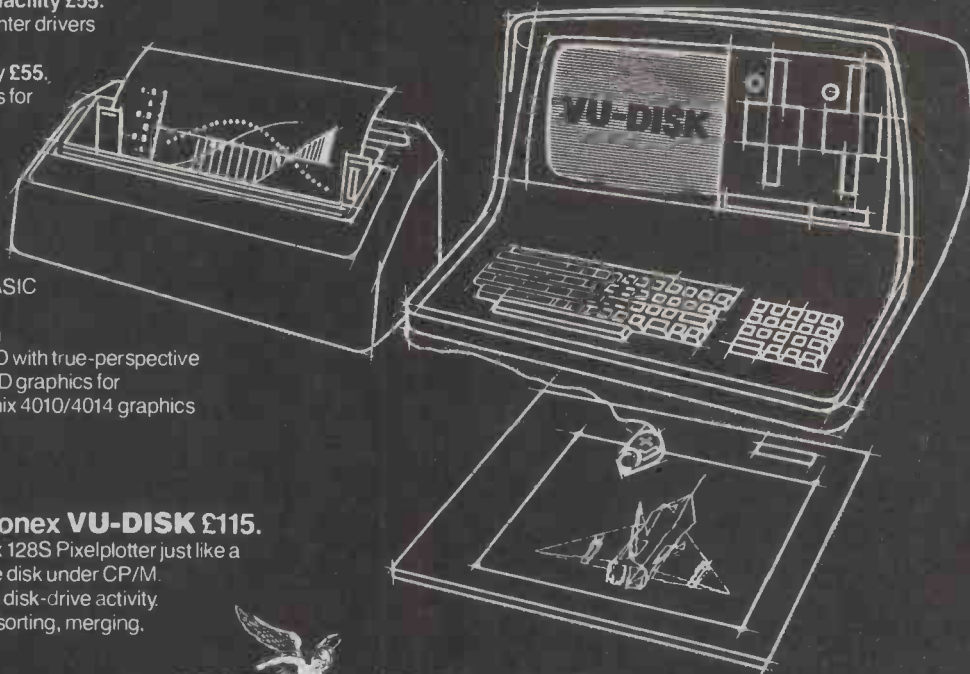

For further details contact:

ICARUS
Computer Systems Ltd.

Icarus Computer Systems Ltd. Deane House 27 Greenwood Place London NW5 1NN Tel: 01-485 5574 Telex: 264209

● Circle No. 304

CITY MICROSYSTEMS LIMITED

65 LONDON WALL, LONDON EC2M 5TU
01-588 7272

SUPERBRAIN



320K, 680K and 1.5MB Diskdrives.
Full graphics available.
Wide range of standard packages.

TELEVIDEO SYSTEMS



Multi-user, multi-task, multi-processor, televideo
reliability with complete expandability.
One to sixteen users.

VIDEO GENIE with VISICALC



Complete system £1275, inc. Computer,
Monitor, Expander, 1-disk drive printer
and Software.
Vast library of standard software.

Complete business accounting systems from £2000. Word processors from £1420

ADVICE, TRAINING AND MAINTENANCE

ALL YOUR COMPUTER REQUIREMENTS READILY AVAILABLE

IN THE CENTRE OF THE CITY — LONDON EC2

VISITORS TO OUR OFFICES MOST WELCOME 10.30am-4.30pm

● Circle No. 307

PROFESSIONAL VIDEO MONITORS

Telefusion have the full range of video monitors manufactured by Electrohome. These monitors are extremely rugged, dependable and available in a variety of screen sizes, and phosphor options, to suit the Communications, Digital, Medical and Industrial Monitoring industries.

As the U.K. authorised distributor and service repair centre, Telefusion can offer competitive prices, expert applications advice and a comprehensive after sales service from our factory, or from the regional depots throughout the country.

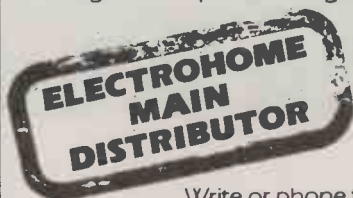
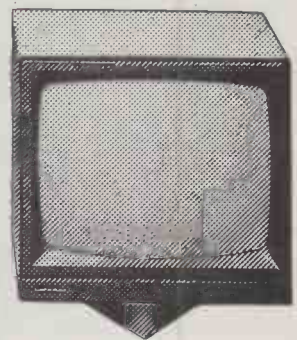
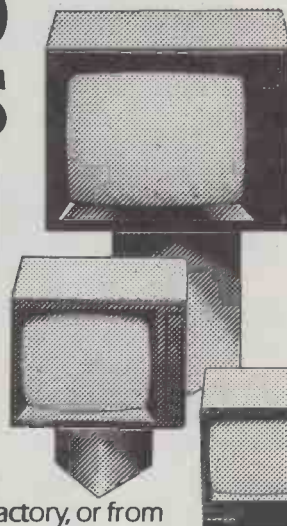

TELEFUSION CONTRACTS DIVISION

Unit 10/11 Barrs Fold Close Wingates Industrial Park
Westhoughton Bolton BL5 3XH Telephone: 0204 66393

Write or phone for further details

● Circle No. 306

microware

MEMOREX FLOPPY DISKS

WHOLESALE PRICES FOR END USERS

5 1/4" Single sided Single density **£1.59**

5 1/4" Double sided Double density **£1.99**

8" Single sided Single density **£2.29**

8" Double sided Double density **£2.99**

Soft Sector
10 Sector
16 Sector
Full range available

MAIL ORDER

Tel: 01-346-8452

DISK STORAGE BOXES

from **£14.95**

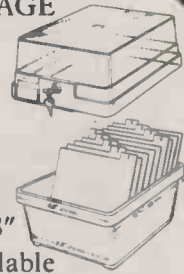

full range of 5 1/4" and 8" models available

Dysan Diskettes

104 1D **£2.45**
104 2D **£3.15**



full range available

In stock

Dust Covers for Micro's & Printers & VDUs from

Floppy Saver Kits from

Indexing Systems from **£2.00**

● Circle No. 308

Advertisement Index

A		D		J		R	
A Solv	189	Data Applications	81	Jarrogate Ltd	206	R. Altwasser	193
A.I. Computers	148	Data Efficiency	92	Johnson Micros	123	Race Systems	47
AC'I	60, 74, 75	Datalect	62			Rair Terminals	29
Adler	124	Dataright	26	K		Research Machines	140
Almarc Data Systems	76	Derwent Data Systems	123	Kai	190	Riva Terminals	104
Altos Computers	82	Digitek	51	Keele Codes	186		
Apple Orchard	192	Discom	186	Kgb Micros	44	S	
Appledore Electronics	210	Disking	185	Knights TV	194	Sapphire Systems	192
Appropriate Technology	211			Kram Electronics	78	S80 Software	196
Arbor Supplies	193	E				Sharp	58, 59
Arcom Control Systems	197	Easicomp Ltd	193	L		Sinclair Research	94, 95
Atlanta Data	145	Electronic Brokers	188	L & J Computers	118	Sintron Electronics	128
		Electronic Office	200	Level Ltd	188	Siron Products	115
B		Empire Computer Systems	131, 139, 154	Lifeboat Association	156	Southdata	201
Bar Instrument Co	191	Empire Systems	4	Logica Ltd	166	Stage One Computers	90
Beebug	154	Euro-Micro	212	London Computer Centre	102	Stottron Ltd	190
BFI Electronics Ltd	26	Exleigh Business Machines	122	Low Electronics	46	Swan Packaging	148
Bromley Computer Consultancy	39			Lucas Logic	8, 9	Symbiotics	138
Bromley Computer Shop	148	F		M		Systematics	52
Butterworths	204	Fonte Data Systems	197	Mass Micros	146	Systems of Tomorrow	166
Byte Shop	126			Mega Video	194		
Byreshop	199	G		Metrotech	14, 15	T	
		Gemini Microcomputers	161	Micro 80	198	Technomatic	63
C		GP Industrial Electronics	158	Micro Mods	194	Telefusion	208
C.I.E.L.	198	Grafcom	16, 17	Microcentre	2	Telesystems	96
Calco Software	72	Gramma Winter	22, 23	Micronetworks	164	Texas Instruments	119
Camden Electronics	122	Granite Chip	154	Micronex Ltd	6, 7	The Software Rental Bank	78
Chromasonic	114	Grundty Business Systems	66, 67	Micropute	155	Tolimit	138
City Microsystems	208			Microsource	196	Transam Components	34
Clapp & Poljack	203	H		Microtroll Engineering	199	T'wickenham Computer Centre	165
Cleniq	147	Hélistar Systems	24, 25	Microvalue Dealers	18, 19		
Comart Ltd	137	Hilderbay Ltd	138	Microware (Idn) Ltd	209	U	
Compshop	134	Hitec	36	Millbank Computers	20, 21	U Microcomputers	30
Compsoft	60	Hotel Microsystems	132	Mitsui	88	Ukom Systems	68
Compusense	200			Molimerx (A. J. Harding)	42		
Computech	84	I		Monolith	204	V	
Computer Fair	27	I.O. Research	206	MPI	12, 13	Vector International	32
Computer Interface Design	190	IBC Computer Systems	210			Vergecourt	195
Computer Plus	165	Ibis Ltd	191	O			
Concept Computers	72	Icarus (Colombia)	38	Overseas Computer Systems	145	W	
CPU Peripherals	10, 11	Icarus (Soft Option)	31			Watford Electronics	46
Crofton Electronics	122	Icarus (Superbrain)	69	P		Welsh Computer Centre	191
Crown Business Centre	195	Icarus Computer Systems	210	Pad-med Computer Services	57	Willis Computer Supplies	122
Crowther Cosine	199	ICE Ltd	146	Pearcom	73		
Ctec	205	ICS	188	Pete & Pam	100	X	
Curmana	97	Inmac (UK) Ltd	145	Prospero	207	X-Data	153
Curmana Ltd	113	Intelligence (IRD) Ltd	162				
CWP Services	28	Intelligent Artefacts	192	Q		Z	
		Interam	106	Quicksilva	202	Zenith Data Systems	53

PROJECT PLANNING WITH MASTER PLANNER

CIFER
APPLE II
APPLE III
SIRIUS
IMS 8000
EQUINOX
NORTH STAR
PDP II
VAX II/780
SUPERBRAIN
VECTOR MZ
MICROENGINE
SCENIC
KEMITRON
EXTEL

LOW COST
SINGLE PAYMENT

SUPPORT
MODIFICATIONS
INSTALLATION

CP/M
OR
UCSD

NETWORK ANALYSIS
RESOURCE ANALYSIS
RESOURCE ALLOCATION
KEY EVENTS
CALENDARS
USER SPECIFIED REPORTS
BAR CHARTS
HISTOGRAMS
RESOURCE OVER/UNDER USAGE
SORTING
SUBNET LIBRARY
CRITICAL PATH REPORT
DEPT/COST CODES
AUTO UPDATE
NETWORK ERROR DETECTION

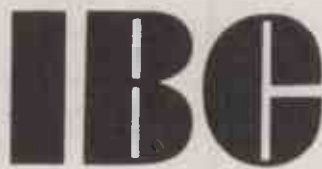

Computer Systems Limited

Sunderland House, Sunderland St., Macclesfield, Cheshire. (0625) 616399

● Circle No. 310

LEARN ELECTRONICS THE 'PRACTICAL' WAY — START WITH A KIT

APPLEDORE ELECTRONICS

Dept. PC.1.
4 MEETING STREET, APPLEDORE, NEAR BIDEFORD, NORTH DEVON EX39 1RJ
TELEPHONE: BIDEFORD (S.T.D. Code 02372) 5629

24hr ANSWERING SERVICE
ORDERING INFORMATION: TERMS OF BUSINESS
— CHEQUE/P.O.s OR BANKER'S DRAFT WITH
ORDER. GOVERNMENT AND EDUCATIONAL IN-
STITUTIONS' OFFICIAL ORDERS ACCEPTED.
TRADE AND EXPORT INQUIRY WELCOME. P AND
P. ADD 60p, EXPORT ORDERS ADD £2.



CLOCK KIT ZULU II

- ★ Operates on 12v AC or 12v DC
- ★ On board XTAL timebase
- ★ Automatic battery back-up
- ★ 24-hour format and 31-day calendar
- ★ 3in. readouts show hrs., mins., secs.
- ★ Unique NOX™ circuit activates readouts with a handclap
- ★ Readouts can be constantly on
- ★ Special noise suppression and a battery reversal circuit

COMPLETE KIT £14.50 EACH
Case optional extra

Plastic Case in BLUE with ruby lens

£4.95

OVERVOLTAGE PROTECTION KIT Complete Kit £9.00

Provide cheap insurance for your expensive equipment. Trip voltage is adjustable from 3 to 30 volts. Overvoltage instantly fires a 25A SCR and shorts the output to protect equipment. Should be used on units that are fused. Directly compatible with the PS-14 and PS-16. All electronics supplied. Drilled and plated PC board.

LOW PROFILE SOCKETS BY TEXAS

8 pin	0.06p
14 pin	0.12p
16 pin	0.14p
18 pin	0.18p
20 pin	0.18p
22 pin	0.18p
24 pin	0.24p
28 pin	0.24p
40 pin	0.28p

SE-01 Sound Effects Kit

The SE-01 is a complete kit that contains all the parts to build a programmable sound effects generator. Designed around the new Texas Instruments SN76477 Sound Chip, the board provides banks of MINI DIP switches and pots to program the various combinations of the SLF Oscillator, VCO, Noise, One Shot, and Envelope Controls. A Quad Op. Amp IC is used to implement an Adjustable Pulse Generator, Level Comparator and Multiplex Oscillator for even more versatility. The 3in. x 3in. PC Board features a prototype area to allow for user added circuitry. Easily programmed to duplicate Explosion, Phaser Guns, Steam Trains, or almost an infinite number of other sounds. The unit has a multiple of applications. The low price includes all parts, assembly manual, programming charts, and detailed 74677 chip specifications. It runs on a 9v battery (not included). On board 100MW amp will drive a small speaker directly, or the unit can be connected to your stereo with incredible results! (Speaker not included.) Main chip SN76477 is included in kit.

COMPLETE KIT ONLY £16

The DOOMSDAY Alarm

THE BEST NOISE-MAKER FOR BURGLAR ALARM

Four separate adjustable oscillators are mixed, stepped and disabled at a rate that is adjustable. The 10-watt output gives ear-splitting volume. The kit comes with all electronics and drilled and plated PC board. Requires 12v DC at 1 amp. Also reqs. 8 ohm speaker (not included). TOTALLY DEFIES INATTENTION.

£10 COMPLETE KIT

CLANG BEEP ZAP! AY-3-8910

COMPUTER SOUND CHIP. The amazing AY-3-8910 is a fantastically powerful sound and music generator, perfect for use with any 8-bit microprocessor. Contains 3 tone channels, noise generator, 3 channels of amplitude controls, 16-bit envelope period control, 2 parallel I/O, 3D/A converters plus much more. All in 40-pin DIP Super easy to interface to the S100 or other Busses.

£5.50 EACH
£2.25 for 60-page
data manual
Data av. with purchase of chip only.

SN76477N SOUND CHIP
£1.60 each
Data £1
Data av. with purchase of chip only.

A single chip versatile **SOUND EFFECTS GENERATOR** SN76477N, is ideally suited for applications such as arcade or home video games, alarms, sound effects boxes and toys.

EPROM 2716
Single 5v
450ns
£2.25 ea.

4116 — 200ns . . . 75p each

Music Boxes
Commercial
Displays
Car Horns
★ Bullet ★

NEW SUPER MUSIC MACHINE KIT!
AT LAST — an affordable kit that can be PROGRAMMED TO PLAY ANY SONG OR GROUP OF SONGS! Instead of a nightmare of numerous ICs and special expensive Bipolar ROMs the SUPER MUSIC MACHINE uses a SPECIAL MASK PROGRAMMED COMPUTER CHIP one CMOS gate and the most popular erasable EPROM, the 2708/2716 series. BASIC KIT includes drilled, plated and screened PC board and ALL components except the EPROM and 12v transformer. The basic kit will play short renditions of 25 tunes through its 7 WATT AMPLIFIER SECTION. Add an optional ROM and any tune programmed will be played.

FEATURES

- Basic kit contains 28 short tunes in the main IC!
- Will address external ROM for up to 1,000 MORE NOTES per ROM (ROM is not included).
- Operates on 12v AC or 12v DC at 500mA. (Using unit on 12v DC and with optional ROM requires 9v bias battery, not included).
- 7 watts of audio power will drive 8 or 16 ohm speakers or horn speakers (not included).
- DIP switches not included.
- NEXT TUNE provision steps sequentially through all tunes.
- Tune address can be wire jumper selected or board is designed to take DIP switches.
- PITCH, VOLUME and TEMPO are all adjustable.
- SPECIAL CHIME SEQUENCES can be activated regardless of tune address to provide for multiple doorbell applications.
- All tunes consist of electronic musical notes played one at a time. There are no chords or harmony sound to the music.
- STEP-BY-STEP ASSEMBLY INSTRUCTIONS provided.

Complete kit £21.00

LEARN ELECTRONICS THE 'PRACTICAL' WAY — START WITH A KIT

● Circle No. 309

The RP1600

FLOWRITER™

A Daisywheel Printer that thinks it's a computer !



The RICOH FLOWRITER is the most intelligent Daisy Wheel printer on the world market. Equipped with an internal micro computer and a large memory it will intelligently handle all printing and word processing operations; hence relieving the host computer for simultaneous use.

The Flowriter is fully compatible with software written for any intelligent printer and is plug compatible with all popular hardware.

Standard Features

- *Prints up to 60 characters in 1 second.*
- *Compatible with QUME SPRINT, DIABLO and NEC Spinwriter standard and enhanced word processing commands including graphics.*
- *Proportional spacing tables programmed internally.*
- *Automatic margin justification even with proportional spacing.*
- *8K buffer under full program control.*
- *Auto bidirectional printing.*
- *Optimised auto logic seeking in both vertical and horizontal directions.*
- *Graphics capability down to 1/120".*
- *Three interfaces included internally: Centronics -IEEE 488 - RS232C.*
- *Detached keyboard option.*
- *External program mode, allows use of many more printwheels.*

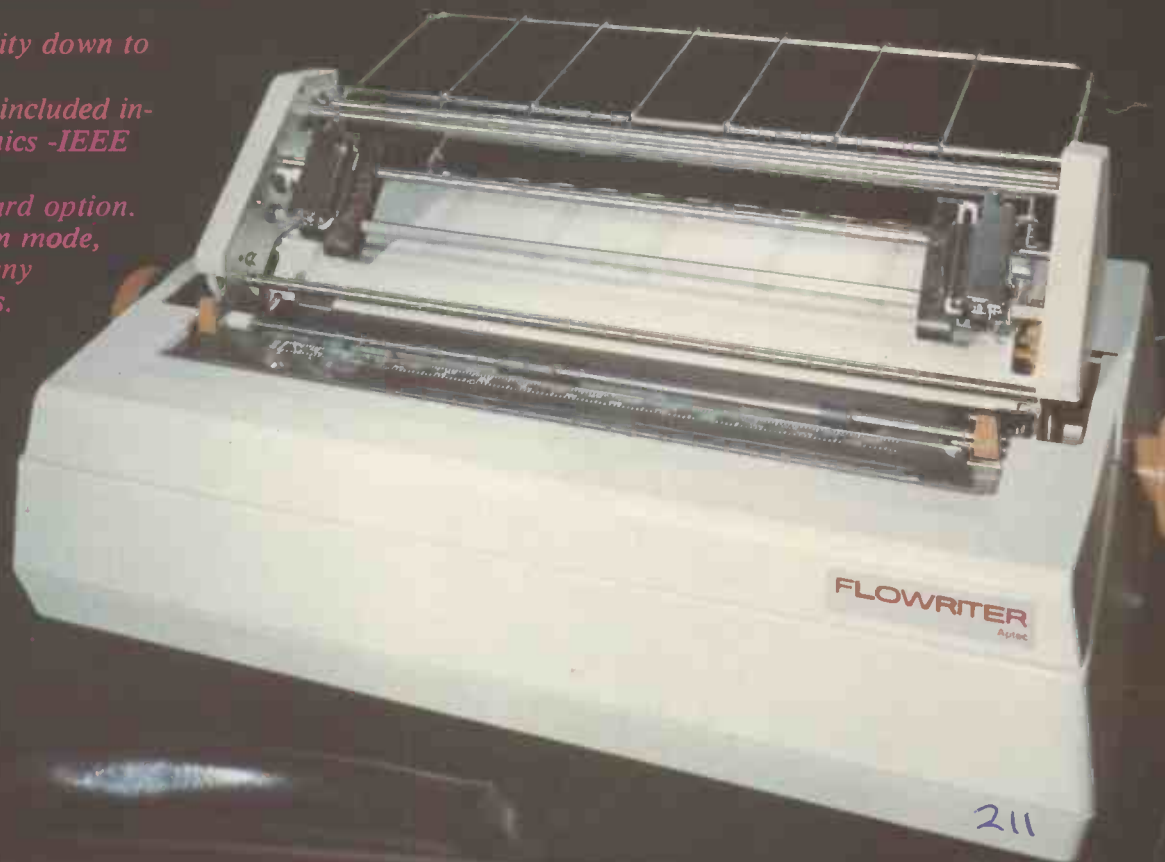

APT APPROPRIATE TECHNOLOGY LIMITED



2-4 Canfield Place London W8 5RT Tel: 01 628 5575/5134 Telex 264538 SSE G

*The RP1600 FLOWRITER is only supplied by APTEC and their authorised dealers, backed by national and international service networks.
The FLOWRITER is designed and manufactured by APTEC UK.*

● Circle No. 311

MAGNETIC bus

8"	floppy	rigid/fixed	rigid/remove
5 1/4"	floppy	rigid/fixed	
tape	9 track	cartridge	

SOFTWARE bus

CP/M* MP/M* 2.1
 PASCALIZ
 FORTRAN
 BASIC
 COBOL
 database
 wordfixing
 financial
 engineering

SYSTEMS bus

shared resources
 file transfer
 gateway to greater things

A full range of terminals
 and printers available



Available without hardware front panel

HARDWARE bus

IEEE S100
 front panel
 graphics
 analogue I/O
 instrumentation
 number-crunch
 eprom/burn
 eprom/emulate
 prototype

For further details on how this quadruple
 decker can help solve your problem call
 today for a SuperFAST™ response.

01-341 2447



EuroMicro Limited
 EuroMicro House, Coleridge Lane, London N8 8ED, England
 Telephone: 01-341 2447

TM SuperFAST, EuroMicro and EuroMicroNet are the trademarks of EuroMicro, Inc.
 *CP/M and MP/M are trademarks of Digital Research Corp.